

The Harmonic Trader

By Scott M. Carney

CRACKED TRADING SOFTWARE

70+ DVD's FOR SALE & EXCHANGE

www.traders-software.com

www.forex-warez.com

www.trading-software-collection.com

www.tradestation-download-free.com

Contacts

andreybbrv@gmail.com

andreybbrv@yandex.ru

Skype: andreybbrv

Library of Congress Cataloging-in-Publication Data

This publication is designed to provide accurate and authoritative information in regard to the subject matter covered. It is sold with the understanding that the publisher is not engaged in rendering legal, accounting, or other professional service. If legal advice or other expert assistance is required, the services of a competent professional person should be sought.

From a Declaration of Principles Jointly Adopted by a Committee of the American Bar Association and a Committee of Publishers and Associations.

Copyright Scott M. Carney, 1999

This material is protected under all copyright laws. This material may not be reprinted or reused in any manner without the express written consent of Scott M. Carney. All rights reserved!

Printed in the United States of America

HarmonicTrader.com
P.O. Box 30088
Tucson, Arizona 85751

TABLE OF CONTENTS

Author's Note	v
Foreword	vii
Acknowledgements	xi
Introduction	1
Part I. Harmonic Trading	
Chapter 1: Harmonic Trading	7
Chapter 2: The Potential Reversal Zone	11
Chapter 3: Gauging Price Action	15
Chapter 4: Invalid Harmonic Set-ups	27
Part II. The Fibonacci Numbers	
Chapter 5: The Fibonacci Sequence	37
Chapter 6: The Primary Numbers	41
Chapter 7: 0.618 Retracement	43
Chapter 8: 0.786 Retracement	59
Chapter 9: 1.27 Projection	67
Chapter 10: 1.618 Projection	85
Chapter 11: The Secondary Numbers.....	97

Part III: Patterns

Chapter 12: Patterns	113
Chapter 13: AB=CD	115
Chapter 14: Gartley 222	157
Chapter 15: Butterfly	189
Chapter 16: Three Drives.....	217

Part IV: Learning the System: Putting it All Together

Chapter 17: Potential Reversal Zone Confirmation.....	247
Chapter 18: Scanning for Stocks.....	257
Chapter 19: Tools for Trading.....	261
Chapter 20: Developing the Trading Plan.....	265
Chapter 21: Gauging the Profit Potential.....	269
Chapter 22: Sticking to the Plan.....	277
Conclusion	283
Appendix	285
Bibliography	303

Part I

Harmonic Trading

1

Harmonic Trading

Harmonic trading is a methodology that utilizes the recognition of specific price patterns and Fibonacci numbers to determine highly probable reversal points in stocks. This methodology assumes that trading patterns or cycles, like many patterns and cycles in life, repeat themselves. The key is to identify these patterns, and to enter or to exit a position based upon a high degree of probability that the same historic price action will occur. Although these patterns are not 100% accurate, these situations have been historically proven. If these set-ups are identified correctly, you can discover significant opportunities with a very limited risk.

One of the earliest references to harmonic trading was made by J.M. Hurst in his cycles course from the early 1970s. His *Principle of Harmonicity* states: "The periods of neighboring waves in price action tend to be related by a small whole number." (Hurst, J.M., J.M. Hurst Cycles Course, Greenville, S.C.: Traders Press, 1973.) The important concept to grasp is that price waves or distinct price moves are related to each other. Futhermore, Fibonacci numbers and price patterns manifest these relationships, and provide a means to determine where the turning points will occur.

When these turning points are identified correctly, trades are executed at a price level where the cycle is changing. Essentially, this type of trading is respecting the natural ebb and flow of buying and selling. In doing so, these trades are executed "in harmony" with the market. For example, when a stock is bought at this turning point, the majority of the selling that has

driven the price down is very close to ending. Quite often, the harmonic techniques identify trades at or very close to the exact reversal point. When these trades yield valid reversals, you will realize the true cyclical nature of price action.

It is important to note that harmonic analysis works on any time frame - hourly, daily, weekly or monthly stock charts. I believe the clearest trade opportunities, or "set-ups," appear on daily charts for position or swing trades. However, hourly charts provide excellent set-ups for shorter-term or day trades. It is also amazing that these methods work on longer-term charts, as well. Weekly or monthly charts are excellent measures of historically critical areas for stocks. As you will see, these methods will gauge price action effectively in any situation.

The most important concept about harmonic trading to remember is that you are respecting the natural cycles of the market. Once you are able to identify these turning points and execute these trades effectively, you will realize that stock price fluctuations are merely cycles of growth (rally) and decline (sell-off). Since these cycles can be quantified by Fibonacci numbers and Price Pattern recognition techniques, it is possible to execute trades with respect to the natural rhythm of the market. In addition, you will realize that such analysis is truly the only means to understand a stock's price action and to define potential trading opportunities.

2

Potential Reversal Zone

An Area of Convergence

History has proven that a convergence of Fibonacci numbers and price patterns provides a highly probable area for a reversal. When such a congregation of numbers occurs, it is possible to assess an optimal point for taking a trade, while defining a loss limit that is very small relative to the potential profit. This area of convergence is called the Potential Reversal Zone.

The key to utilizing these harmonic measures when analyzing a price chart is to determine the area where the greatest amount of numbers congregate. When three, four or even five numbers come together within a specific area, you must respect the high probability for some type of reversal.

It is important to closely examine price action in the potential reversal zone. When a congregation of numbers occurs, a stock tends to act quite uniquely from past price action. If a reversal does occur, often the stock will literally bounce off the area, holding in the reversal zone for only a short period of time. However, if the reversal zone is invalid, the price action usually will be extreme and will provide clear signals that this trade opportunity is to be avoided.

The stock charts in this book illustrate how a convergence of harmonic numbers has an unusual effect on price action. It is almost uncanny that these stocks act in such a manner. Although I can not explain why these stocks act in this way, I know from studying thousands of charts that a convergence of harmonic numbers has a profound effect on price action.

"A Feel for the Numbers"

Once you learn these techniques, the potential reversal zone can be easily calculated. If you can add, subtract, multiply and divide, you can determine the potential reversal zone. However, determining which number within the reversal zone is the best entry point for a trade can be a tricky task. Developing "a feel for the numbers" within the harmonic area takes practice and experience. But, there are general rules of thumb that will help optimize the execution within the potential reversal zone.

Fibonacci numbers are very peculiar because in a reversal zone that contains several harmonic calculations, it is difficult to know which point will end the trend. Although these rules are generalizations, I believe that there is a certain degree of weighting to the numbers.

In general, the bigger the number, the better. This means that the Fibonacci number that is calculated from the largest price leg is usually the most significant, as an entry point for a trade in a reversal zone. Another rule of thumb is the bigger the pattern, the more significant the potential reversal. For example, a pattern that develops on a weekly chart will be more significant than a set-up on a daily basis. Also, if there is a smaller pattern within a larger pattern, the larger pattern usually will be more significant.

Another important consideration involves the harmonic numbers within the potential reversal zone. The more numbers that exist within a specific area, the more harmonic the potential reversal zone. This is an important rule of thumb because a very harmonic area will indicate a great deal about a stock's direction. For example, if a potential reversal zone contains four or five numbers, the area should be considered very harmonic. If a stock reverses from this area, the potential reversal zone could be considered as an important turning point. But, if a stock does not reverse, it would indicate that the predominant trend is quite strong.

The potential reversal zone should be considered even more harmonic, if the numbers are very close to each other. When a congregation of harmonic numbers is within a point, the area should be considered very

significant. Also, when there is an area of three or more numbers, it is important to examine where the closest convergence of numbers occurs within that potential reversal zone.

It is important to note that these methods are not an exact science - it's more like an art. Although these methods do require precise calculations, a "feel for the numbers" is essential to gauge accurately the price action, to determine valid reversals and to optimize trade executions.

These skills require consistent dedication to research past harmonic examples and to analyze current set-ups. The initial "training" period will be mentally challenging. However, once you have gained experience with these techniques, it will become much easier to identify harmonic opportunities and successfully execute trades.

I have a friend who recently earned his pilot's license. Although he was able to grab the controls and fly the plane on his first lesson (with the instructor present), it took him almost a year of consistent flying before he was able to really develop a feel for the airplane. On one flight, he allowed me to take the controls. He instructed me to maintain the altimeter at a specific level. I took command of the controls and started to fly the plane.

As I was flying the plane, I wanted to look out the cockpit and admire the scenery around me. However, every time I looked out the window, the plane's altitude dropped. I would look back at the altimeter and ascend to adjust our altitude back to the required height. After flying the plane and maintaining the altitude by focusing directly on the instrument gauges for a few minutes, my curiosity would get the better of me. Sure enough, I would begin to sightsee. As soon as I did, the plane's altitude would drop. When my friend took over the controls after my attempt to fly the plane, he was able to maintain the altitude precisely without looking at the altimeter at all. He told me that it took him an initial period of training before he was able to maintain the plane's altitude without looking at the altimeter. It required many hours of flying to develop his feel for the plane.

In the same manner, these methods for identifying harmonic set-ups require training and practical experience. Although you might be able to calculate Fibonacci numbers and identify patterns that define potential reversals, these methods require that special touch of intuition, earned through dedicated and consistent work, before these techniques can truly be mastered.

3

Gauging Price Action

Price Bars

Since a stock's trading action is exhibited through individual price bars, it is important to have a basic understanding of these formations. There are four basic elements of a price bar: open, close, high, and low. Although this may seem very simplistic, it is important to review the nature of price bars because a stock's price action within the potential reversal zone will determine the validity of the harmonic set-up.

Bullish Price Bar

The open and the close define a bullish price bar. Simply, if the close is above the open, the price bar is considered bullish. The degree of bullishness can vary based upon the distance between the open and the close.

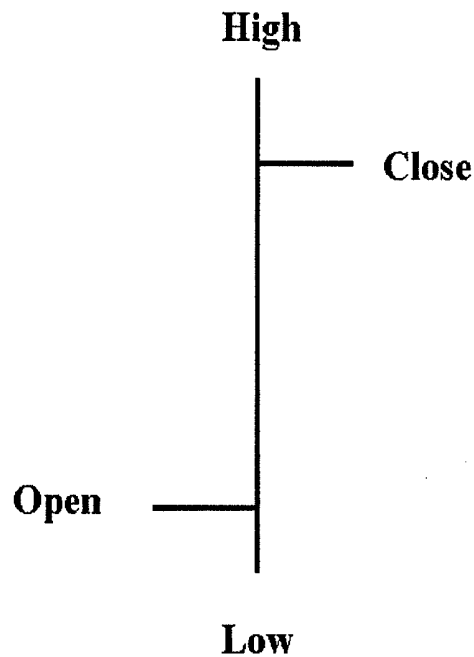

Bullish Price Bar

This simple illustration is very crucial because it defines the result of trading within a specific time frame. Since a bullish price bar represents a stock that closes above the open, it is possible to draw certain conclusions regarding the price action. In essence, a bullish price bar manifests the result of more buyers than sellers during that particular time period. When this price bar appears in a bullish potential reversal zone, it signifies that the trend is potentially changing.

Bearish Price Bar

A bearish price bar is identified by the open and close, as well. In a bearish price bar, the close is below the open.

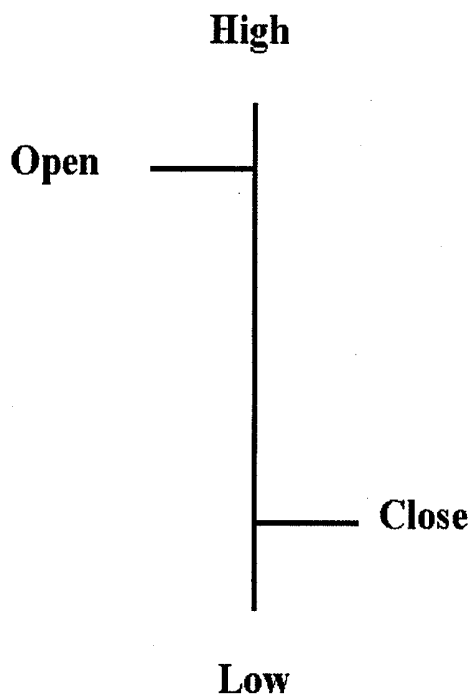

Bearish Price Bar

Again, this is a very simple illustration. However, it is important to understand this basic framework, to define price action. Similar to the bullish price bar, the bearish price bar is the result of trading within a specific period of time. However, the bearish price bar means that there are more sellers than buyers. When this price bar forms in a bearish potential reversal zone, it can signal a reversal, as well.

Price Bars in the Potential Reversal Zone

As a stock enters into a potential reversal zone, it is important to examine the nature of the price bars. This will help determine the validity of a potential reversal within the harmonic area. The nature of the price bars also will indicate the strength or weakness of the price action.

In a potential reversal zone, there is a specific price range, where a stock "should" turn around. I say "should" because the potential reversal zone is an area that is highly probable for a change in trend. It is not 100% guaranteed. However, as you will see, the harmonic area does identify excellent areas for potential reversals. Therefore, a stock's price bars within this harmonic area will determine the validity of that potential reversal.

Ideal Reversals

Ideal reversals frequently occur in potential reversal zones. Sometimes, a stock will reverse exactly off an important harmonic calculation. These instances are easy to decipher. However, the ideal reversal does not always occur in a potential reversal zone. But, if you understand how a reversal "should" occur, you will be able to decipher valid reversals within a harmonic area.

There are two important aspects of a reversal to observe within this harmonic area. The most important characteristic of the price action in the potential reversal zone is some type of turn around or change in the previous trend. This would be evidenced by price action that exhibits a price bar that is opposite to the predominant trend. For example, if you were looking to buy a stock that was forming a bullish pattern, you would want to see a bullish price bar in the potential reversal zone. As the stock is declining, the price action most likely would form bearish price bars. However, if the stock began to reverse, as evidenced by bullish price bars in the harmonic area, a potential reversal could be developing. Reversals in an area with several harmonic numbers often form in this fashion. But, one price bar that is opposite to the current trend does not entirely signify a valid reversal.

Reversal Continuation

The other element of a valid reversal is some type of continuation of that change in trend. Using the bullish example again, if a stock started to rally after hitting the potential reversal zone, it should be followed by another bullish price bar. In this example, it would be ideal if the price bar rallied and closed above the previous high, while maintaining a higher low. The concept of continuation is essential in providing evidence of a valid reversal. Although the following illustrations are very simplistic, it is important to have an understanding of standard reversal action.

Ideal Bullish Reversal

In an ideal bullish reversal, it is important to see a bullish price bar in the potential reversal zone. Ideally, a bullish continuation will validate the reversal.

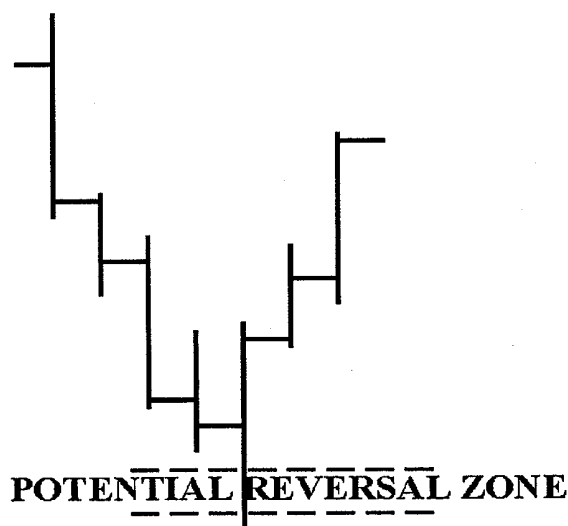

Ideal Bullish Reversal in Potential Reversal Zone

Obviously, this is a very ideal situation. But, stocks frequently reverse like this after hitting a harmonic area. The important concept is to

witness some type of turn around, followed by price action that has higher highs and higher lows. In addition, the stock should continue to form bullish closes - that is, higher than the open.

Ideal Bearish Reversal

In an ideal bearish reversal, it is also important to observe price action in the potential reversal zone. When a stock hits the harmonic area, it is important to see a bearish price bar, followed by a continuation of that new downtrend.

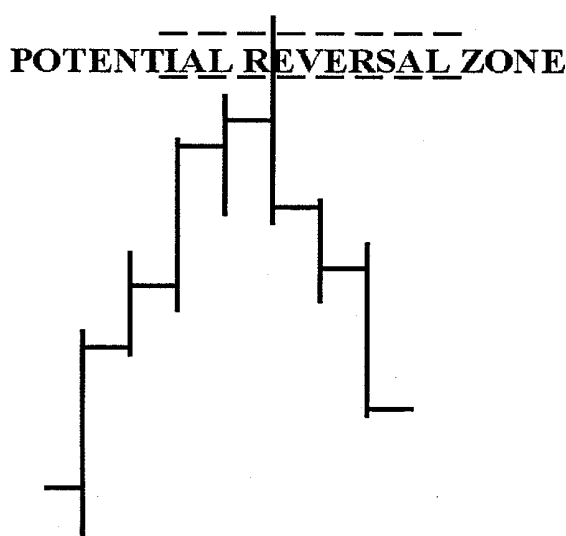

**Ideal Bearish Reversal in
Potential Reversal Zone**

The primary signs of the bearish continuation will be a stock that makes lower highs and lower lows, after the reversal is complete. Also, the stock should continue to close below the open. These are the primary signs that will validate a bearish reversal.

Although these concepts may seem over-simplified, they serve as standards by which valid reversals can be determined. Establishing some type of standards of price action will create a better understanding of a valid reversal. This understanding will help you develop a "feel" for how a stock "should" act in the potential reversal zone. Although stocks do reverse in

harmonic areas that vary from the ideal illustrations, these basic concepts will help identify valid reversals that can yield substantial moves.

Japanese Candlesticks

Another method to exhibit a price bar is a Japanese candlestick. These formations illustrate the nature of a price bar in a very clear manner. Japanese candlesticks have been used for centuries. Originally, they were developed to chart the price of rice markets. There are several excellent books on candlesticks that I recommend you read. One of the most comprehensive books that I have ever read on Japanese Candlesticks is Japanese Candlestick Charting Techniques, by Steve Nison. (New York: New York Institute of Finance, 1991.) It is a fascinating area of technical analysis. However, for these purposes, I will illustrate only the most basic of candlestick price bars.

Bullish Candlestick

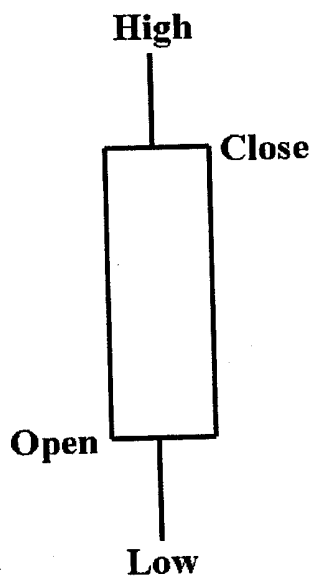

Bullish Japanese Candlestick

A price bar that has an area that is clear or white represents a bullish candlestick. As you can see, the enlarged area shows the difference between the open and close.

The candlestick illustrates the price action more clearly than a single, line price bar. Also, in combination with a harmonic set-up, the candlestick can provide greater indication of a potential reversal.

Bearish Candlestick

A filled or black bar depicts the bearish candlestick. This price bar also shows the range between the open and close more clearly than a single, line price bar.

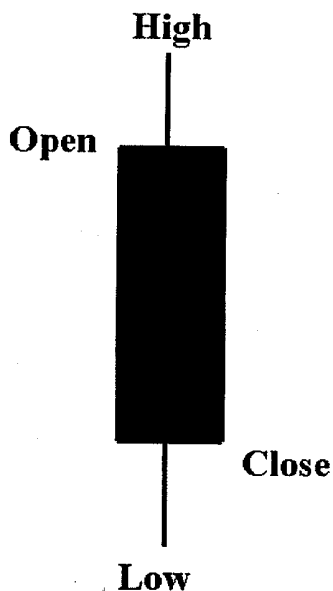

Bearish Japanese Candlestick

Candlesticks are excellent measures of price action because they clearly illustrate the range between the open and close. Although the total range of a stock is important, the difference between the open and the close can provide even greater indication of future price action.

Other Significant Japanese Candlesticks

Other candlestick formations are very significant when they materialize in a potential reversal zone. These candlesticks provide an even stronger indication of a potential reversal when they form in a harmonic area.

Doji

The doji is an excellent potential reversal signal. It occurs when the open and the close are the same. Usually, the open and close are found in the middle of the price range.

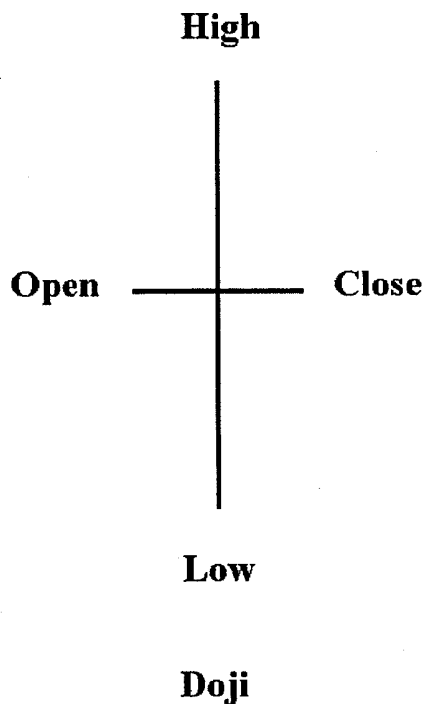

This price bar indicates a market that is uncertain of its future action. It is important to closely watch the price action following the formation of this price bar. This will often provide clear signals regarding the future trend of a stock.

Hammer

The hammer is a price bar that has a large total range with a small difference between the open and the close. This difference should be approximately 1/3 the total range for a valid hammer. Depending on where it develops on a stock chart, there are other terms for this price bar, such as a hangman or shooting star. However, for these purposes, it is important just to recognize this as a reversal signal, especially when it forms in a potential reversal zone.

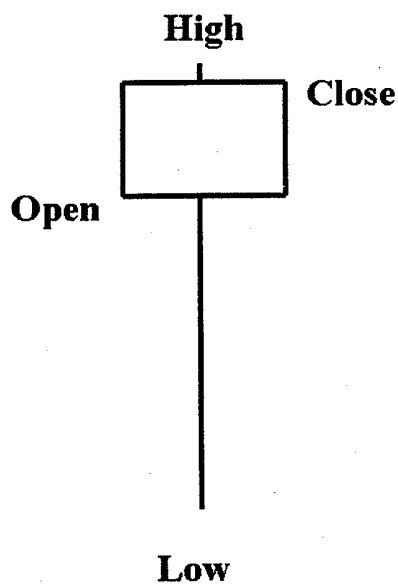

Bullish Hammer

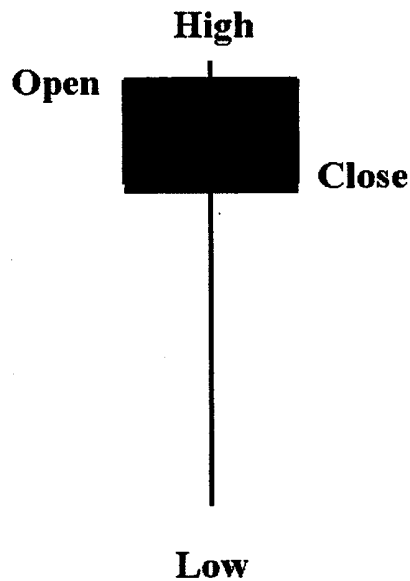

Bearish Hammer

The next illustration shows a hammer that is inverted. Again, it is important to recognize this sign as an indication of a potential reversal when it develops in a harmonic area.

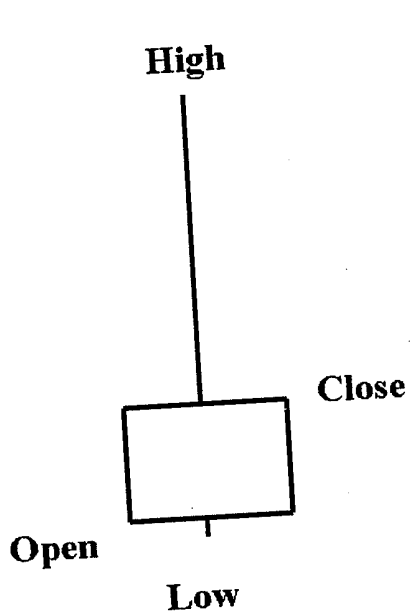

Bullish Inverse Hammer

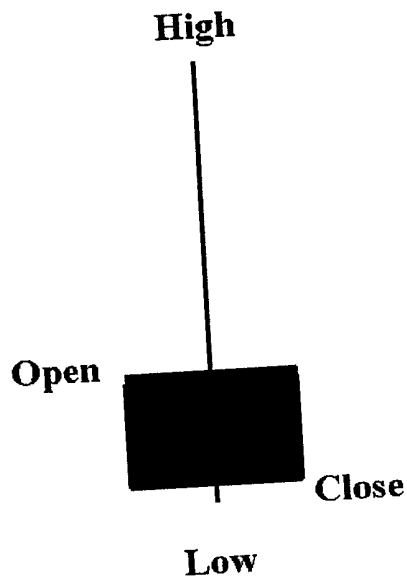

Bearish Inverse Hammer

Japanese Candlesticks clearly illustrate a stock's price action. I believe that candlesticks can indicate a great deal more about a future price action than a single, line price bar. Also, there are several combinations of candlesticks that identify critical turning points in stock. I strongly encourage you to study this area of technical analysis. Although these are very basic illustrations and explanations of candlesticks, it is important to recognize these price bars as reversal formations in a potential reversal zone.

4

Invalid Harmonic Set-ups

The stock market often provides clues to determine future price action. Although anything can happen in the stock market, harmonic set-ups that experience price action that acts completely opposite to what is anticipated usually will provide signals to indicate the flawed nature. This is not to say that a harmonic set-up will not go completely against you - because it can. But, in my experience, the market will provide evidence of "probable future action."

It is important to read these signs that the market offers to gauge the next potential move. After you develop the feel for harmonic price action, you will be able to determine how a stock "should" act within a potential reversal zone.

The Warning Signs

Blowouts

Blowouts, as I refer to such price action, occur when the potential reversal zone is completely violated. Potential reversal zone blowouts are associated with three primary warning signs: price gaps, tail closes and abnormally large price ranges. It is almost uncanny how frequently these warning signs occur to warn against a potentially flawed harmonic reversal zone. But, they are reliable indicators of an invalid set-up.

As I mentioned previously, harmonic areas are excellent opportunities for defining profitable stocks, but they do not work all of the time. It is essential to study the price action in the potential reversal zone, especially if the area contains several harmonic calculations within a close range. As you examine these situations, let the market provide the clues of its next move. When warning signs develop, they act as clear signals that the area is not a good opportunity.

Although warning signs will signal a potentially flawed set-up, it is also important to examine the following price action. Since blowouts represent strong price action, the stock should continue to trade in that direction.

This principle of continuation is extremely important because it will define the significance of the warning sign. For example, if a stock gaps up on the open and finishes with a bullish close, this would indicate a strong stock. Due to the strength of this price action, you might expect the stock to move higher. However, if a stock does not move higher after such a move, the stock could be considered potentially weak. Therefore, warning signs should exhibit some type of follow through to confirm the price action.

Price Gaps

It is very common for price gaps to occur in a potential reversal zone. A price gap occurs when the price action opens beyond the previous close, leaving an open area where no trading has occurred. A price gap in a potential reversal zone indicates that the set-up is to be treated with extreme caution. It is important to respect an extreme sign like this because a price gap indicates a significant change in sentiment.

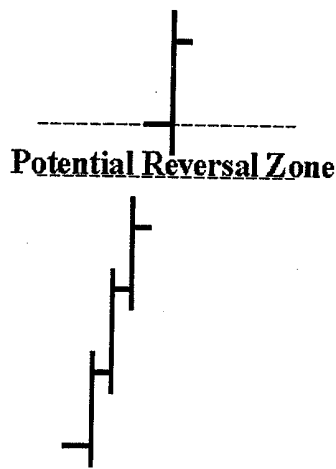

**Bullish Gap:
Price Gap through the
Reversal Zone**

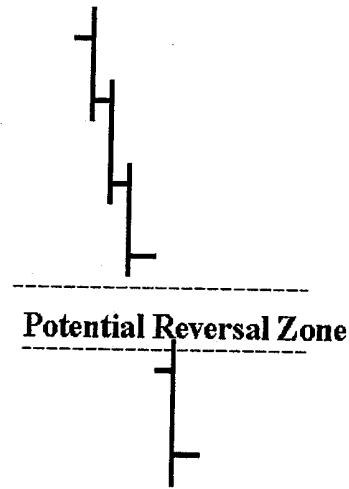

**Bearish Gap:
Price Gap through the
Reversal Zone**

I believe that a price gap in the potential reversal zone occurs most frequently and is the strongest of all of the warning signals. A price gap is an extremely significant indicator of an invalid set-up and has kept me out of many bad trades.

Tail Closes

Tail closes are price bars that close at either the high or low. Tail closes suggest extreme price action that is to be respected. Therefore, when a tail close occurs after hitting a potential reversal zone, it is prudent to exercise extreme caution.

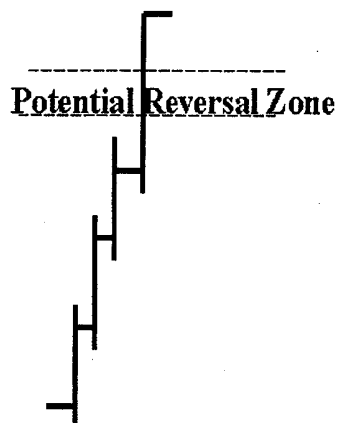

**Bullish Tail Close:
Tail Close through the
Reversal Zone**

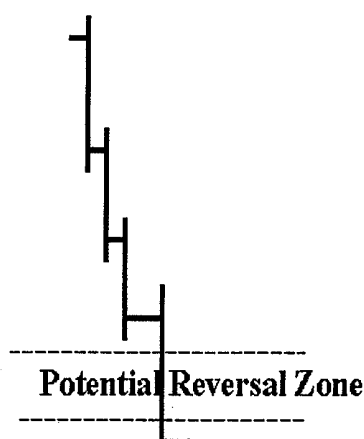

**Bearish Tail Close:
Tail Close through the
Reversal Zone**

When a stock closes at the high or low of the day, it indicates sentiment that is overwhelmingly strong. If you take a moment to really contemplate the meaning of this price action, it indicates that the majority of the participants trading the stock are extremely biased in one direction. It is almost common sense to wait for an obvious reversal signal in this situation because of the strength of the price action. Therefore, a tail close is a clear signal to step aside and let the market give you the signals of when to enter or exit a trade.

Extreme Price Ranges

Extreme price ranges also reflect a very strong trend. Such overwhelming action signals unusual activity that is to be respected. One way to determine if a price range is extreme is to compare it to the average range. As a rule of thumb, if a stock trades greater than one and a half times its average range, it can be considered extreme. However, it is not necessary to calculate this comparison, because an extreme price range should be practically obvious.

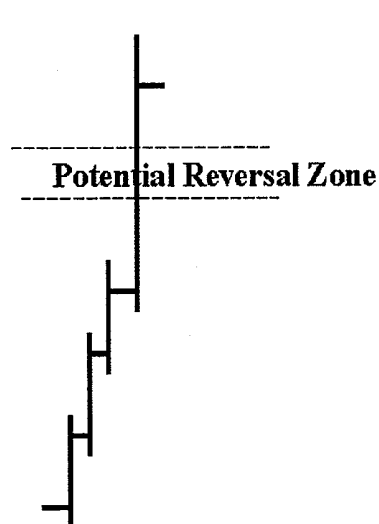

**Bullish Extreme Price Range:
Price Bar through
the Reversal Zone**

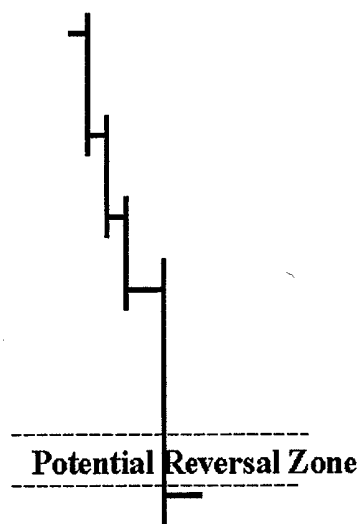

**Bearish Extreme Price Range:
Price Bar through
the Reversal Zone**

Although extreme price ranges signal a potentially flawed set-up, I have observed many valid reversals that occur despite such price action. In fact, I believe that the extreme price range frequently can indicate a state of exhaustion. I say this with one condition: the exhaustion must be confirmed by the following price action. If the extreme price range reflects an exhaustive price move, the next price bar should not continue in the same direction. But, if the warning sign is a valid indicator of a flawed set-up, the stock should continue to trade in the same direction. Therefore, it is

important to respect this warning sign. But, it is even more important to observe some type of continuation of the price action.

When harmonic set-ups are blown-out, the price action is providing very significant information about the primary trend. Since a potential reversal zone is a critical area to examine, the price action will indicate a great deal about the current trend. In the case of a blowout, the price action will indicate that the predominant trend is very strong, especially if the stock continues beyond the potential reversal zone.

Blowouts actually can be opportunities to reverse the initial trade idea, suggesting that you should "go with the flow," and enter a trade in the predominant trend. Reversing an original trade set-up can be difficult. Specifically, there is an emotional element involved with reversing that may be difficult to overcome. A perceived harmonic set-up that has previous experiences attached to the opportunity suggests that if a reversal has occurred under similar conditions in the past, the same result should occur. When these "expectations" are involved in a failed trade set-up, a degree of attachment and/or bias sets into the psyche that distorts what the market action is actually revealing.

At times, it can be very frustrating to wait for a set-up to materialize, only to have a warning sign develop in the potential reversal zone. In fact, it happens to me very often. Sometimes, I will wait a week or even a month for a significant set-up to complete, only to have the trade negated by a warning sign. However, I have learned that these signs accurately warn against a losing trade. At a minimum, if I believe that the trade is a fantastic opportunity, I will wait at least one price bar before executing my order.

One Price Bar Rule

The most important consideration when assessing a warning sign is the price action after the stock enters the potential reversal zone. Frequently, stocks will reverse, despite such warning signs. So, it is important to wait for the market to provide some type of confirmation of the reversal.

When a set-up is extremely harmonic - possessing three or more numbers in the potential reversal zone - the opportunity can be still be valid. However, waiting at least one price bar will prevent you from "jumping in front of a runaway train." As I mentioned before, the principle of continuation will be very indicative of the validity of the reversal. A stock that continues in the predominant trend beyond the potential reversal zone will definitely invalidate the trade. However, if a stock reverses after a

warning sign, such price action might signal that the harmonic area still is a valid trade opportunity. Sometimes, it is prudent to wait even a few price bars for a clear reversal signal.

Accepting a trade despite a warning signal can be a tricky execution. I usually will enter a trade only when a potential reversal zone is extremely harmonic. Although waiting for clear a reversal signal delays my execution, I have learned the significance of the warning signs. Respecting these signs has prevented me from many flawed executions.

Harmonic Trading Summary

The following chapters will truly change the way you view stocks. They will clearly illustrate that these methods are reliable indicators of price trends. When a convergence of harmonic calculations exists within a specific area, the potential for a reversal is highly probable. It is essential to gauge the price action within the harmonic area to determine the validity of the reversal. Also, warning signs frequently will indicate a flawed set-up. So, it is important to wait at least one price bar, or even several, to see if the trade is still valid.

The harmonic techniques are most effective when you are patient. These opportunities will materialize frequently, providing ample opportunities to be consistently successful. It is important to study actual examples to achieve a greater understanding of price action. It will take some time before your "harmonic comprehension" improves. But, if you invest the time, the skill that you learn will truly be worth the effort.

Part II

Fibonacci Numbers

5

The Fibonacci Sequence

Fibonacci numbers are based upon the Fibonacci sequence discovered by Leonardo de Fibonacci de Pisa (b.1170-d.1240). Fibonacci was one of the greatest mathematicians of the Middle Ages. His most famous work, the Liber Abaci (Book of the Abacus), was one of the earliest Latin accounts of the Hindu-Arabic number system.

In this work, he presented and was mostly responsible for the use of arithmetic numbers rather than Roman numerals, which were the common means of numeric recording of that time. His book introduced the Arabic art of Algebra to the Roman civilization. Fibonacci also was renown for his study of the Great Pyramids of Egypt.

It was during this time that he developed the Fibonacci number sequence, which is historically the earliest recursive series known to date. The series was devised as the solution to a problem about rabbits. The problem is: If a newborn pair of rabbits requires one month to mature and at the end of the second month and every month thereafter reproduce itself, how many pairs will one have at the end of n months? The answer is: u_n . This answer is based upon the equation: $u_{n+1} = u_n + u_{n-1}$.

Although this equation might seem complex, it is actually quite simple. The sequence of the Fibonacci numbers is as follows:

0, 1, 1, 2, 3, 5, 8, 13, 21, 34, 55, 89, 144, 233, 377 \longrightarrow
up to infinity

Starting with zero and adding one begins the series. The calculation takes the sum of the two numbers and adds it to the second number in the addition.

$(0+1=1)\dots(1+1=2)\dots(1+2=3)\dots(2+3=5)\dots(3+5=8)\dots$
 $\dots(5+8=13)\dots(8+13=21)\dots(13+21=34)$

After the eighth sequence of calculations, there are constant relationships that can be derived from the series. For example, if you divide the former number by the latter, it yields .618.

$34/55 = .618181 \sim .618$
 $55/89 = .617977 \sim .618$
 $89/144 = .618055 \sim .618$
 $144/233 = .618025 \sim .618$

Dividing the latter number by the former number derives another relationship from the sequence. This relationship yields approximately 1.618.

$55/34 = 1.617647 \sim 1.618$
 $89/55 = 1.618181 \sim 1.618$
 $144/89 = 1.617977 \sim 1.618$
 $233/144 = 1.618055 \sim 1.618$

The 0.618 and the 1.618 are two of the four Fibonacci-related numbers that I use to consider price action harmonic. The other two numbers that are derived from the series, the 0.786 and 1.27, are the square root of the 0.618 and the 1.618, respectively.

These four numbers have been found to exist in many natural and man-made phenomena. The .618 and the 1.618 constants from the series are found in the Great Pyramids. Comparing the height to 1/2 its base derives these relationships.

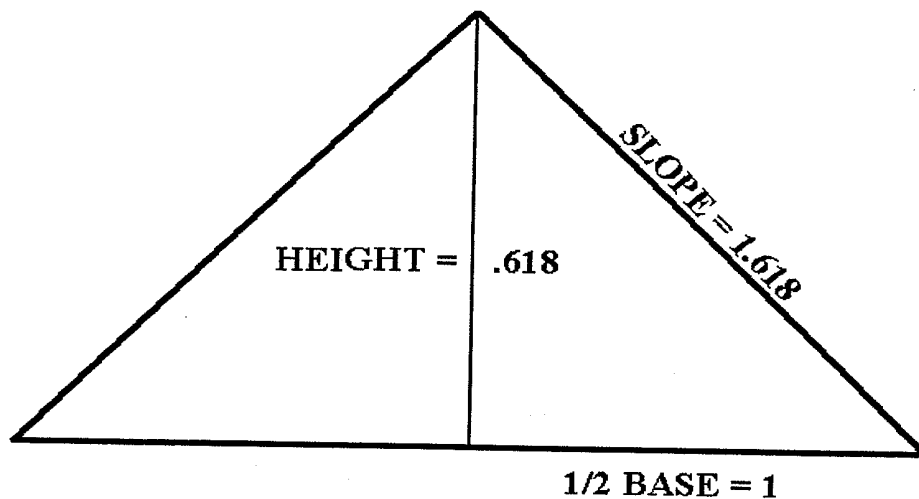

Fibonacci's additive series is based upon the equation:

$$\text{Phi} + 1 = \text{Phi squared}$$

$$\text{Base} = 2.00$$

$$\text{Half Base} = 1.00$$

$$\text{Height} = .618$$

$$\text{Slope} = 1.618$$

Not only do these constant numeric relationships occur in the Fibonacci series, there are also universal examples that exhibit this phenomenon. For example, Venus takes 225 days to complete a revolution around the sun. As we all know, the Earth requires 365 days to complete one revolution. If you divide 225 by 365, the result is approximately .618 of a year. ($225/365 = .6164 \sim .618$) That's amazing!

Although these concepts might seem difficult to grasp, these examples demonstrate that there is something very peculiar about this mathematical phenomenon. I want to emphasize that I am not any sort of mathematician,

astronomer or astrologer. In fact, the first time that I studied this information, I was completely confused. But, as I researched these subjects more thoroughly, I realized that these numbers did possess unusual relationships to the universe.

As I began to utilize these numbers in my trading, I realized that these numbers frequently occur in stock charts. So, the primary concept to grasp is that these numbers exist for a reason. As you begin to study these numbers in relationship to stock charts, you will realize that they are effective tools in gauging price action.

6

The Primary Numbers

The primary Fibonacci numbers are the essential means to gauge price action accurately and to identify potential trade opportunities. These numbers are used to determine patterns as harmonic. The primary numbers consist of: 0.618, 0.786, 1.27, 1.618. These four numbers should become the basis for identifying any potential trade opportunity. A stock chart must be considered harmonic, when price action is observed to reverse off these numbers in a specific fashion. If a stock “bounces” off these numbers, you should assume that more harmonic action would continue in the future.

The most important function of these numbers is that they are a means of quantifying price action. By establishing certain areas to study, it is possible to determine or “gauge” a stock’s price action. Although stocks often exceed the exact number slightly, it is very common for stocks to make significant reversals after they hit a certain Fibonacci projection. Therefore, Fibonacci numbers create critical areas that must be examined to determine the future trend of a stock.

When you initially study stock charts using Fibonacci numbers, I believe you will be surprised by the price action around these critical areas. Frequently, a stock will act “unusually” when it hits a Fibonacci number. In

my opinion, when a stock enters a potential reversal zone, it often will possess price action that is abnormal, as compared with the previous history. If the stock reverses, the price action will possess price bars that are opposite from the predominant trend. If a stock does not reverse, it usually will exhibit a warning sign at these areas.

It will take some time to develop the analytical skills required to gauge price action. After you study many examples, you will begin to realize how Fibonacci numbers affect price action. Furthermore, when these numbers are analyzed in combination with the recognition of certain price patterns, you will realize that the harmonic techniques define the price zones that have the greatest probability for reversal.

7

0.618 Retracement

The .618 is probably the most popular Fibonacci retracement percentage that is used by technicians. Often, technicians will round the number and just state that this percentage is a two-thirds retracement. I strongly urge that the exact .618 retracement percentage, carried to three decimal places, be used. I have witnessed many patterns that have completed exactly at the .618. Therefore, utilizing a rounded number of two-thirds or 66% will not yield the same results as the precise .618 for Fibonacci calculations. Let's look at some examples of .618 retracements.

Bullish .618 Retracement

The bullish .618 is an important retracement area for a stock that is selling off. When I see a sharp sell-off in a stock that has completed a nice rally, the .618 retracement is the first area that I examine for a potential reversal.

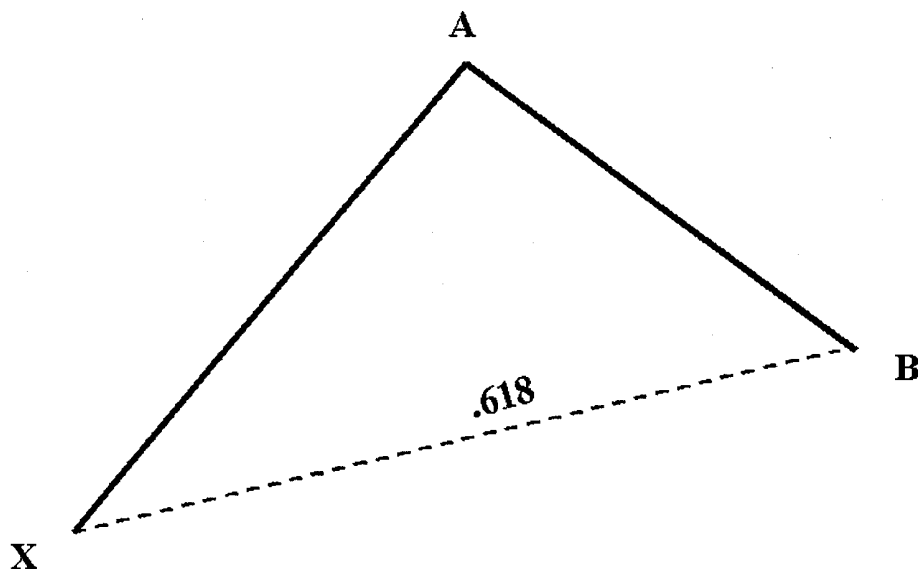

BULLISH .618 RETRACEMENT

BUY AT B!

During a decline, I will wait for the stock to approach the .618 area and observe the price action. If the sell-off is extreme, as indicated by a warning sign, I will wait one price bar before executing a trade at the .618 retracement area. However, if a stock finds support in this area, exhibited by a reversal price bar, I will buy at the .618

It does take some time to be able to decipher the price action accurately at the Fibonacci numbers. However, if you study the major declines like the following examples, you will learn how the market provides clues regarding the nature of the price action.

The first chart illustrates a bullish .618 retracement nicely. Amazon.com is an excellent example of an incredibly volatile stock that possessed very harmonic price action.

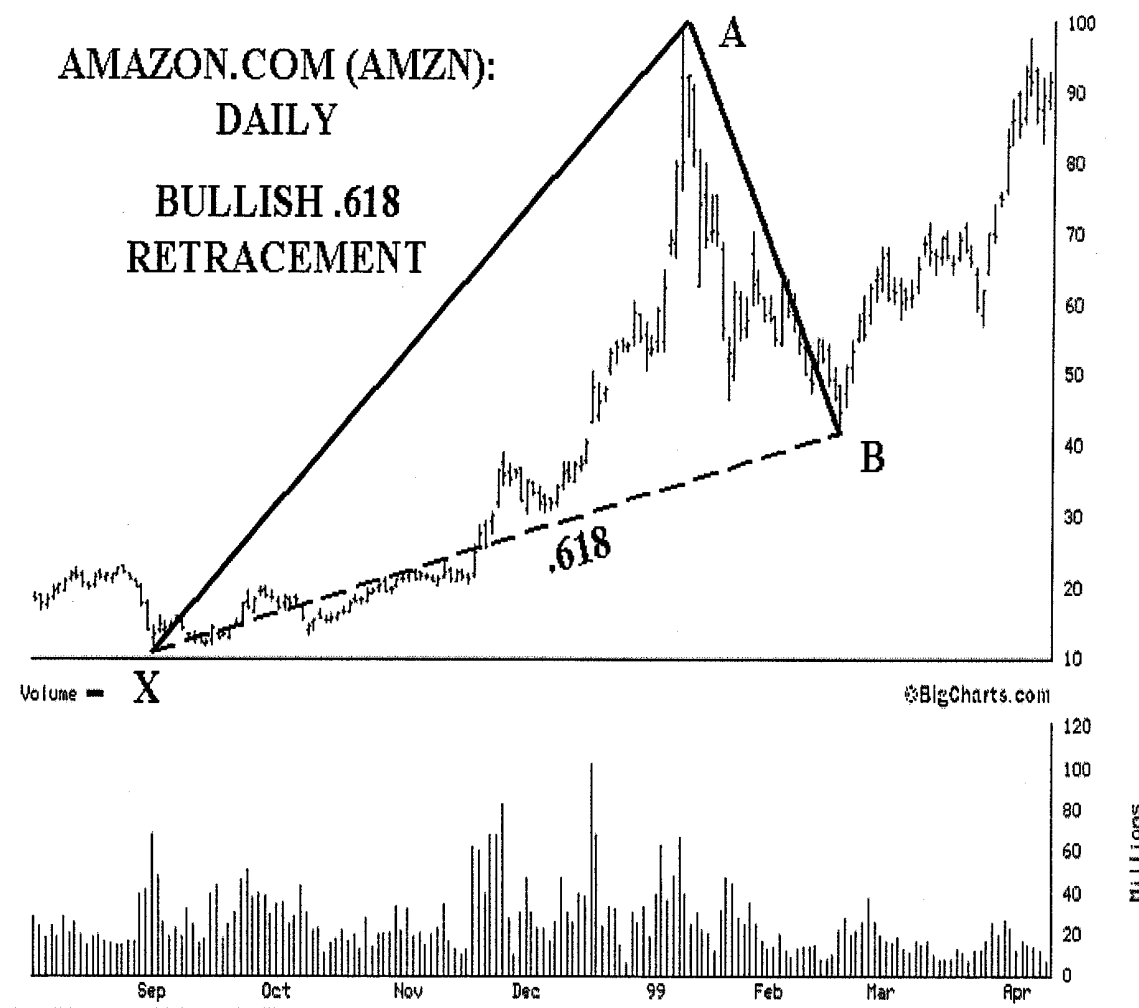

It is amazing that this stock rallied over 800% in less than five months and retraced almost exactly to the .618 of this move. In fact, after selling off more than 60 points, AMZN reversed on the same day it hit the .618.

I want to take a moment and explain the means of calculating the Fibonacci retracement. The September low at 10 13/16 (Pt. X) was subtracted from the January 1999 high at 99 9/16 (Pt. A). The difference between the high and the low was $88 \frac{3}{4}$ ($99.5625 - 10.8125 = 88.75$). I multiplied 88.75 by 0.618, which was equivalent to 54.8475. I subtracted this amount, approximated at $54 \frac{27}{32}$, from the stock's high at 99 9/16 ($99.5625 - 54.8475 = 44.6785$). This calculation approximates to $44 \frac{11}{16}$.

The stock bottomed at 42 1/8 (Pt. B) and rallied sharply. Although the stock possessed a bearish price bar on the day it hit the .618 retracement, the next day clearly exhibited a reversal price bar, as the stock gapped up on the open and closed above the previous day's high. In fact, Amazon.com rallied up seven days in a row without breaking the previous day's low. Such price action is very significant after reversing off a Fibonacci retracement. Furthermore, this chart reveals an ideal reversal, as the stock bounced on the day it hit the .618 and exhibited a bullish continuation of higher highs, lows and closes.

The following enlarged chart shows the price action of Amazon.com at the .618 retracement. It is important to notice how the stock began a new uptrend after hitting the retracement.

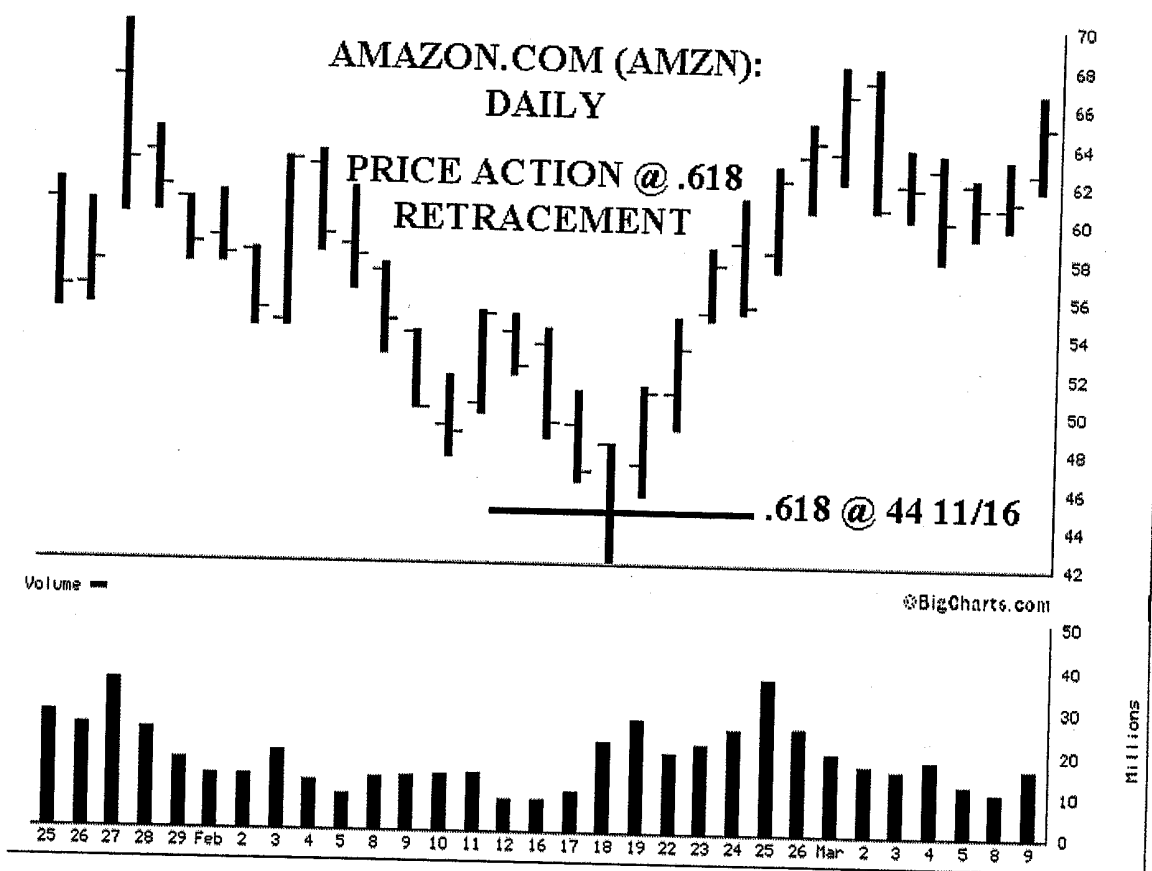

In such an extreme sell-off like this one, it is prudent to wait one price bar to confirm the reversal. In this case, Amazon sold off over 50 points in a very short time. So, I believe these circumstances require some additional caution. But, the reversal at the .618 retracement indicated an excellent area to buy the stock.

The next weekly chart of Ebay clearly shows the power of a .618 retracement. In this case, the stock sold off sharply from its high, losing 2/3 of its total value in approximately four months and reversed almost exactly off the .618 retracement.

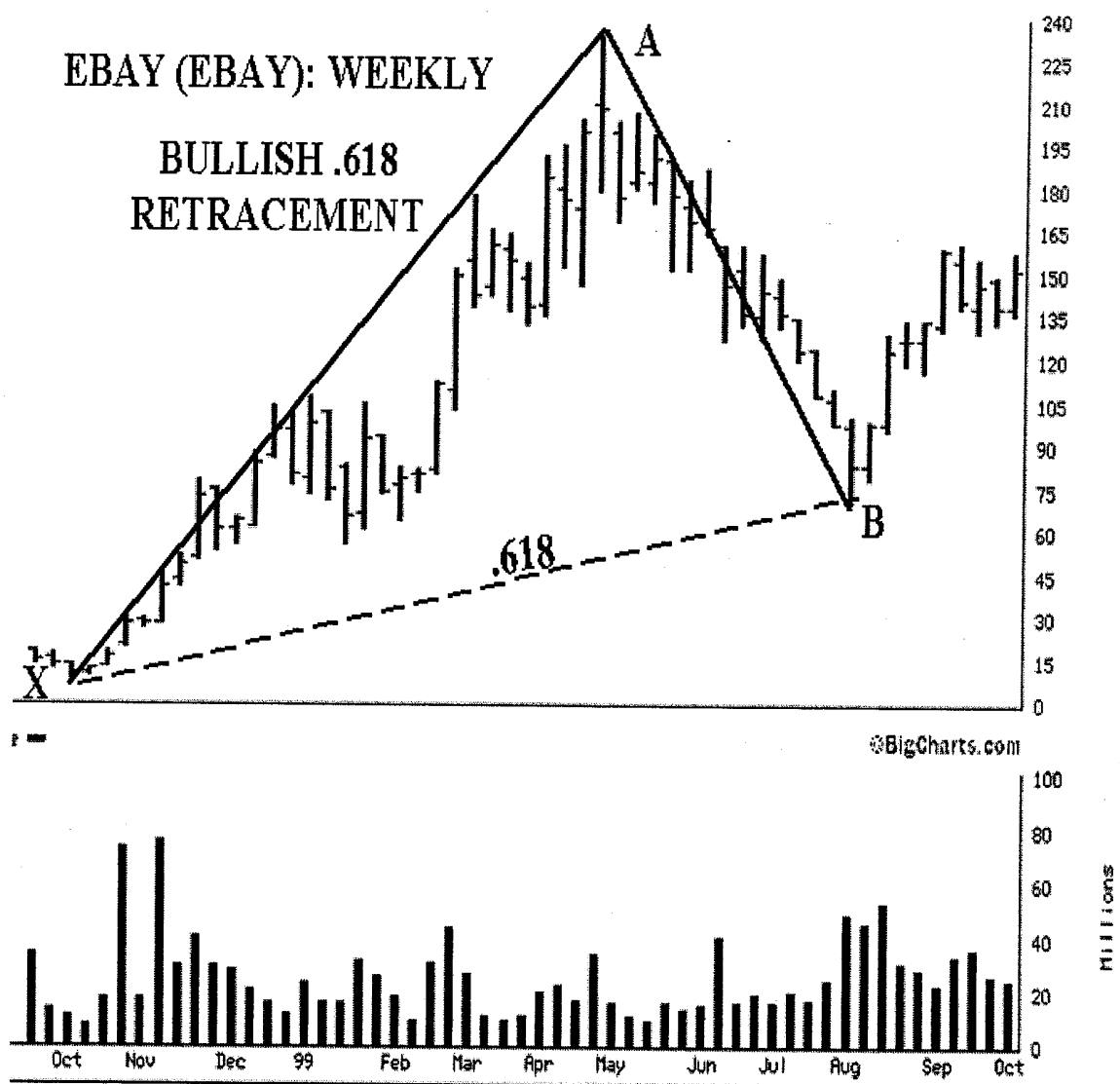

Despite this sharp decline, the stock literally bounced on the week that it hit the .618. In fact, not only did the stock bounce on the day it hit the projection, it bounced within two hours after slightly exceeding the number.

After declining past the .618 retracement, which was calculated at 74 1/2, the stock established a clear reversal off this area. The stock bottomed at 70 5/16 and rallied sharply from this low. In particular, Ebay exhibited a nice bullish continuation. Within the next six weeks, the stock doubled from

its low! I have included the following chart that clearly shows the reversal off the .618 retracement.

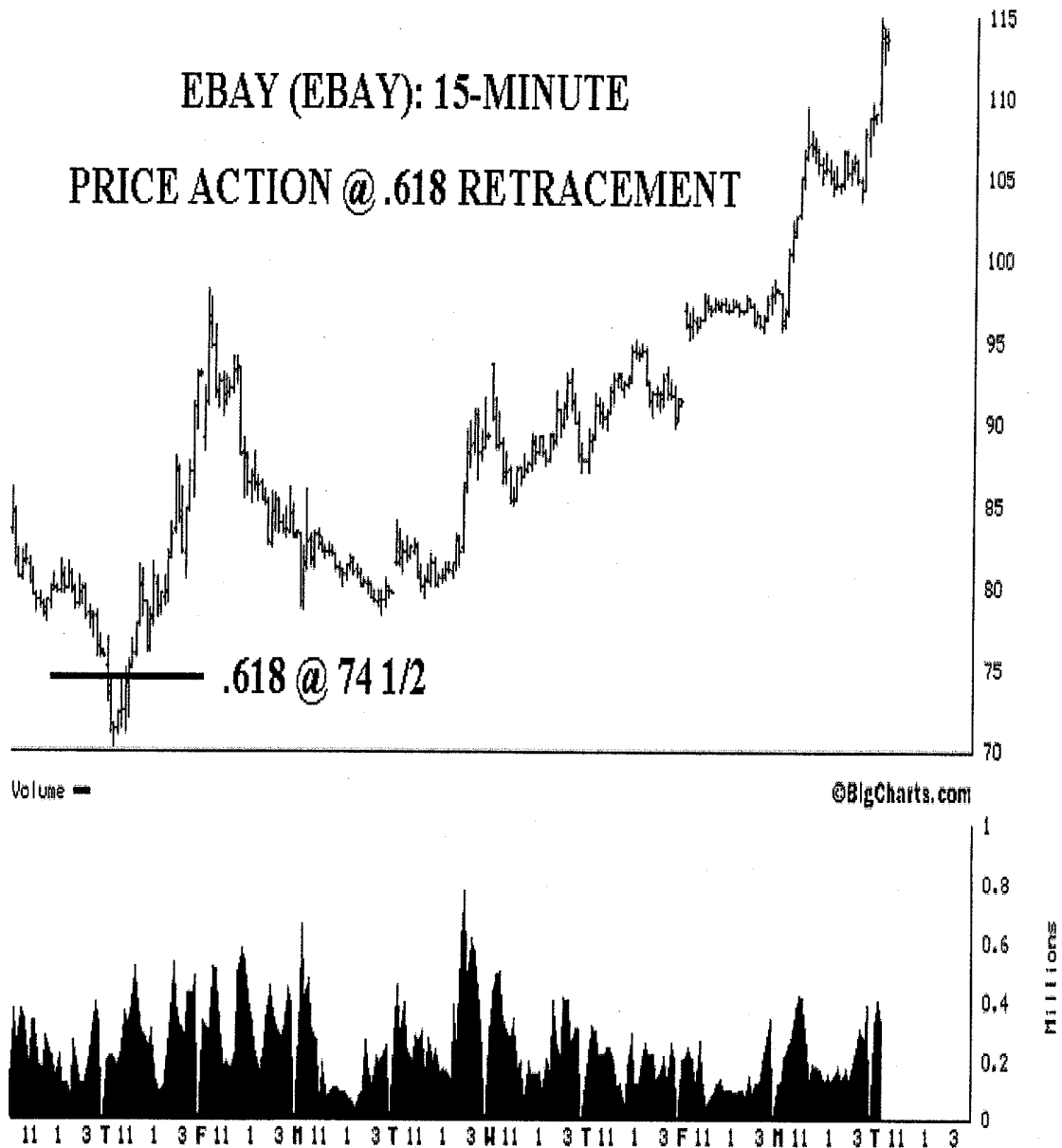

These examples of Amazon and Ebay are truly awesome! They illustrate the significance of the .618. The price action in these examples provided clear signals of reversal confirmation, as it possessed convincing continuation of a new uptrend. Although these stocks seemed to be “crashing” preceding the reversal, they found excellent support at the .618 retracement and yielded fantastic rallies.

Bearish .618 Retracement

A bearish .618 retracement after a strong sell-off occurs very frequently. A reversal off the bearish .618 usually indicates a continuation of the downtrend. In my opinion, if a reversal occurs at the .618, it will not exceed the area very much. In fact, if a reversal is valid at the .618, the stock "should" possess a bearish price bar after hitting this number.

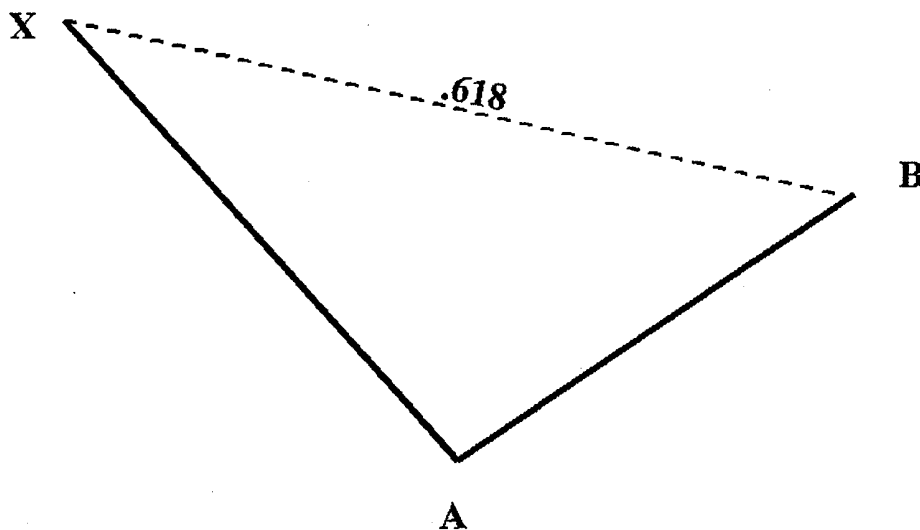

BEARISH .618 RETRACEMENT

SELL AT B!

Reversals off the exact .618 do occur. However, it is important to study the price action in the area close to the retracement. If a stock begins to stall or break down, it would indicate that the .618 is acting as resistance. It is important to recognize these signals when the stock hits this area.

The important aspect of this Fibonacci retracement is that in a bearish retracement, it is the first potential area of major resistance. So, if I am long or I am looking to short a stock that is rallying after a significant decline, I want to look specifically in the .618 area for a trade opportunity. The following examples will illustrate the bearish .618 concept.

3Com Corporation suffered a serious beating, as the stock sold off nearly 60 points in the beginning of 1997. The stock then rallied, experiencing a “dead cat bounce” that reversed right off the .618. After reversing, the stock declined again, losing all that it recovered. Let’s look at the chart.

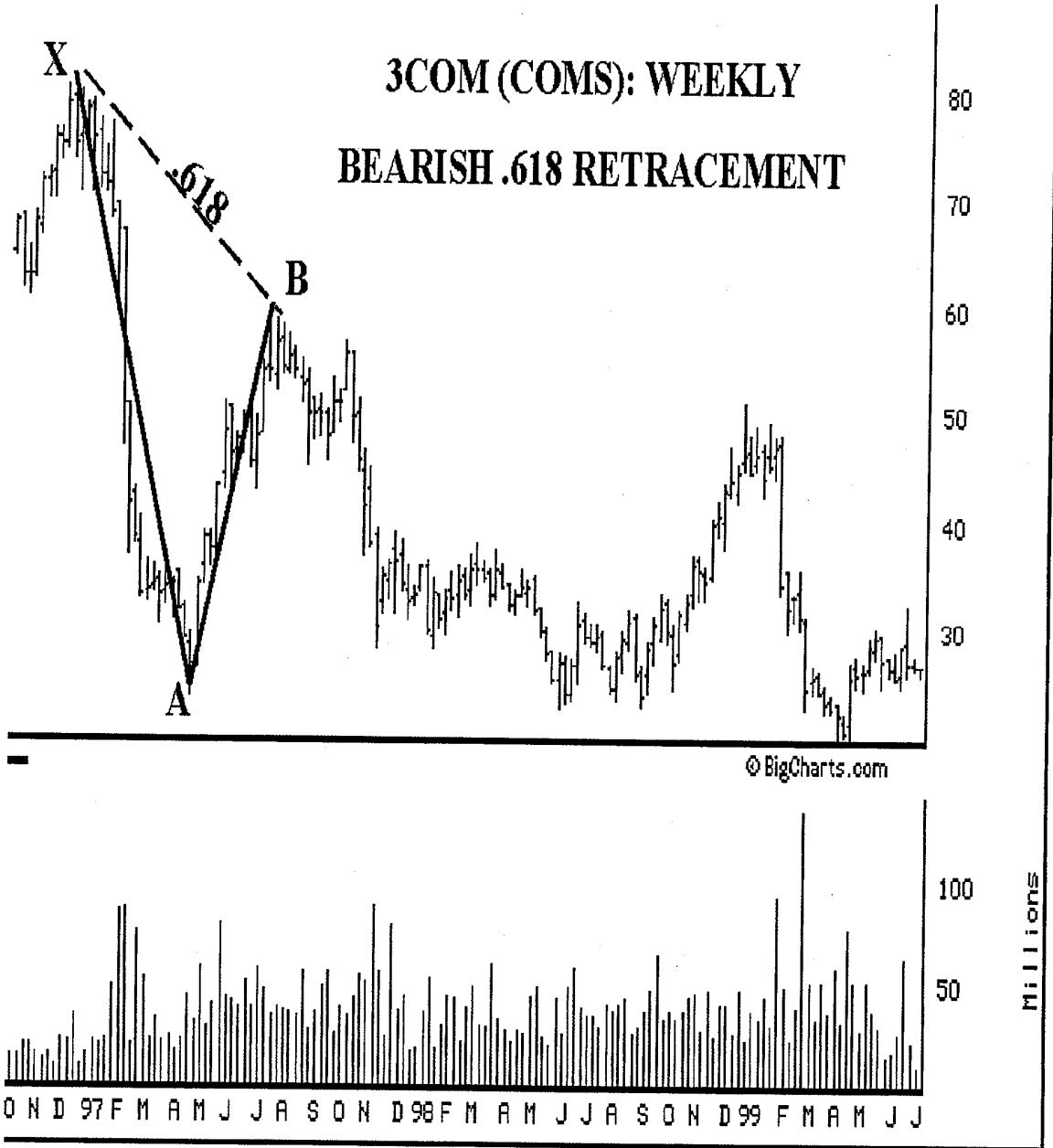

3Com experienced enormous resistance at the .618 retracement of the previous decline. In fact, the stock reversed after exceeding the .618 by less than 3/8 of a point. The .618 retracement of the decline of the XA leg was

projected at 59 7/16. The stock hit 59 3/4 and reversed! Within a few days after hitting the .618, the stock sold off steadily.

I have included an enlarged chart that clearly shows the price action at the .618 retracement. The price action indicated severe resistance, as the stock formed a very bearish price bar on the week that it hit the .618.

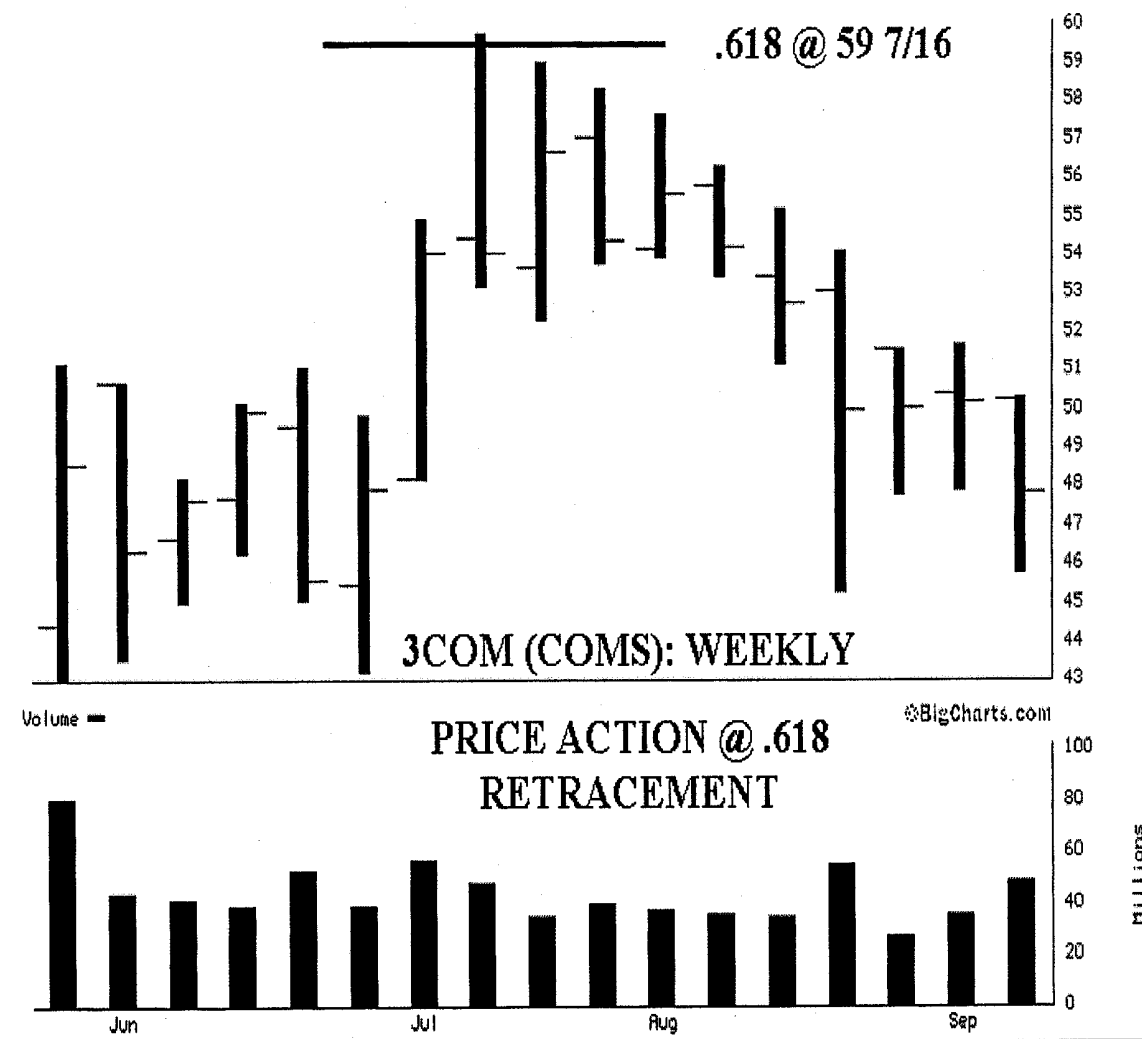

This chart shows that 3Coms could not rally above the .618. In fact, the stock stalled after hitting the retracement, only to sell off steadily within a few weeks after the reversal was complete.

In this situation, if you were long this stock, you must respect the resistance of the .618 and take profits. If you were looking to short 3Com, the sharp reversal at the .618 should have indicated that the rally off the bottom was in trouble. Understanding such price action in the future will help you gauge the true nature of a stock's trend.

The next example illustrates the .618 as clear resistance. This daily chart of Dell Computer shows how the stock reversed almost exactly off the .618 projection of the prior decline.

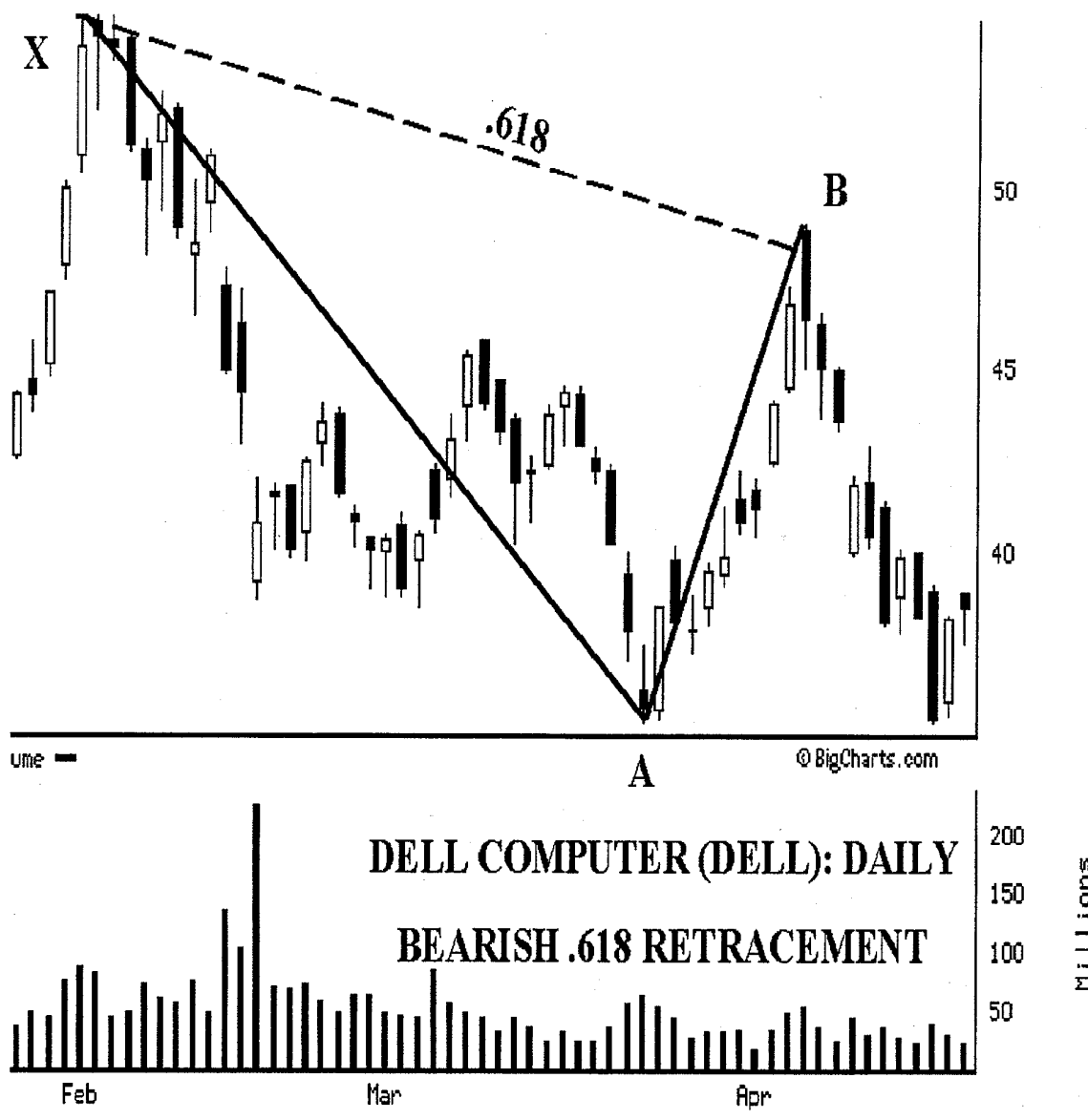

An interesting aspect of this chart is the individual price bar on the day the stock hit the projection. The stock possessed a very bearish candlestick after it hit the .618 retracement. Dell sold off from a high of 55 (pt. X) and bottomed at 35 $\frac{7}{16}$ (pt. A). The .618 projection of this move was calculated at 47 $\frac{9}{16}$. The stock exceeded this projection slightly, as it reversed at 48 $\frac{21}{32}$ (pt. B). So, even if you waited a day, the bearish continuation confirmed the valid reversal.

When a stock forms a bearish price bar at the .618, as Dell did in the previous example, the price action must be watched closely. In this instance, the following day provided significant confirmation of the trend reversal because Dell broke the prior day's low and closed below the prior day's close. This continuation following a clear reversal off a Fibonacci number would have signaled that this stock started a new bearish down trend. This reversal yielded over 10 points in the next two weeks.

.618 Channel

In my experience, a stock that reverses off a .618 is very strong. In an uptrend, .618 reversals usually signify a positive continuation, especially if the initial upswing is a strong move. Conversely, in a downtrend, .618 reversals suggest the continuation of that negative move. Let's look at some illustrations and examples.

.618 Bullish Channel

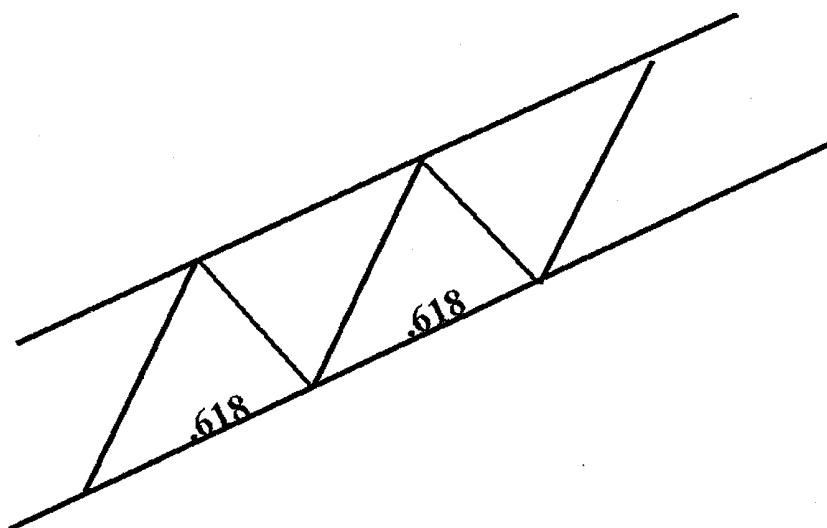

**BULLISH CHANNEL:
SUPPORT AT .618 RETRACEMENTS**

It is very common to observe .618 retracements in clearly defined channels. Channels are trending ranges that maintain a consistent slope of

an angle. When Fibonacci numbers and patterns complete near an extreme range of a channel, you should be aware of such potentially powerful implications.

For example, let's say you are following a strong uptrend. A clear channel has developed in which a stock has traded within an increasing trend range. A potential opportunity develops when the stock sells off to the low range of that trend channel. Knowing that the stock has found support at the .618 retracement of the prior rally, a potential trade set-up exists. The lower trend channel that serves as potential support can validate the trade set-up.

In this example, it would be even more advantageous if the .618 retracement was located just below that lower trend channel. Often, strongly trending stocks with obvious price channels will briefly break through the lower end of the range "to shake investors out" of a good position before heading higher. When this set-up occurs and the .618 retracement is just below the trend line, the opportunity will not require much of a stop loss limit – maybe a point or two below the .618 retracement - to see if the trade will work.

When a stock breaks through its lower range of the uptrend channel, it should "reveal itself" rather quickly. Usually, if it is a shakeout, the price action should reverse quickly. However, if the ride is over and the uptrend channel will not continue to go higher, the price action should have downside follow through, where the stock continues to head lower.

If the "breakdown" is valid, warning signs, such as gaps, wide price ranges and tail closes, will indicate the strength of the move. Therefore, if the stock breaks past the trend line and the .618 considerably, you will know that these points are no longer providing support. So, you close out your position and take the loss. Let's look at an example of a bullish uptrend with .618 retracements.

The following chart of Eli Lilly clearly illustrates this situation. The stock established a very bullish uptrend that found support at the .618 of the prior rally every time it attempted to sell off. This daily chart clearly shows price action that is literally bouncing off the .618 in this channel. You could have followed this uptrend, waited for a sell-off and bought every time the stock retraces to the .618. There were several times when Eli Lilly sold off past the lower trend line and reversed at the .618.

When these situations occur, you know that your risk is very limited. Since the stock violated the lower trend line, the .618 is the only potential support. If the stock breaks past the .618 retracement, you can assume that

the uptrend is no longer intact. Therefore, you only have to risk a point or two below the .618 to see if the reversal will occur.

ELI LILLY (LLY): DAILY

.618 BULLISH CHANNEL

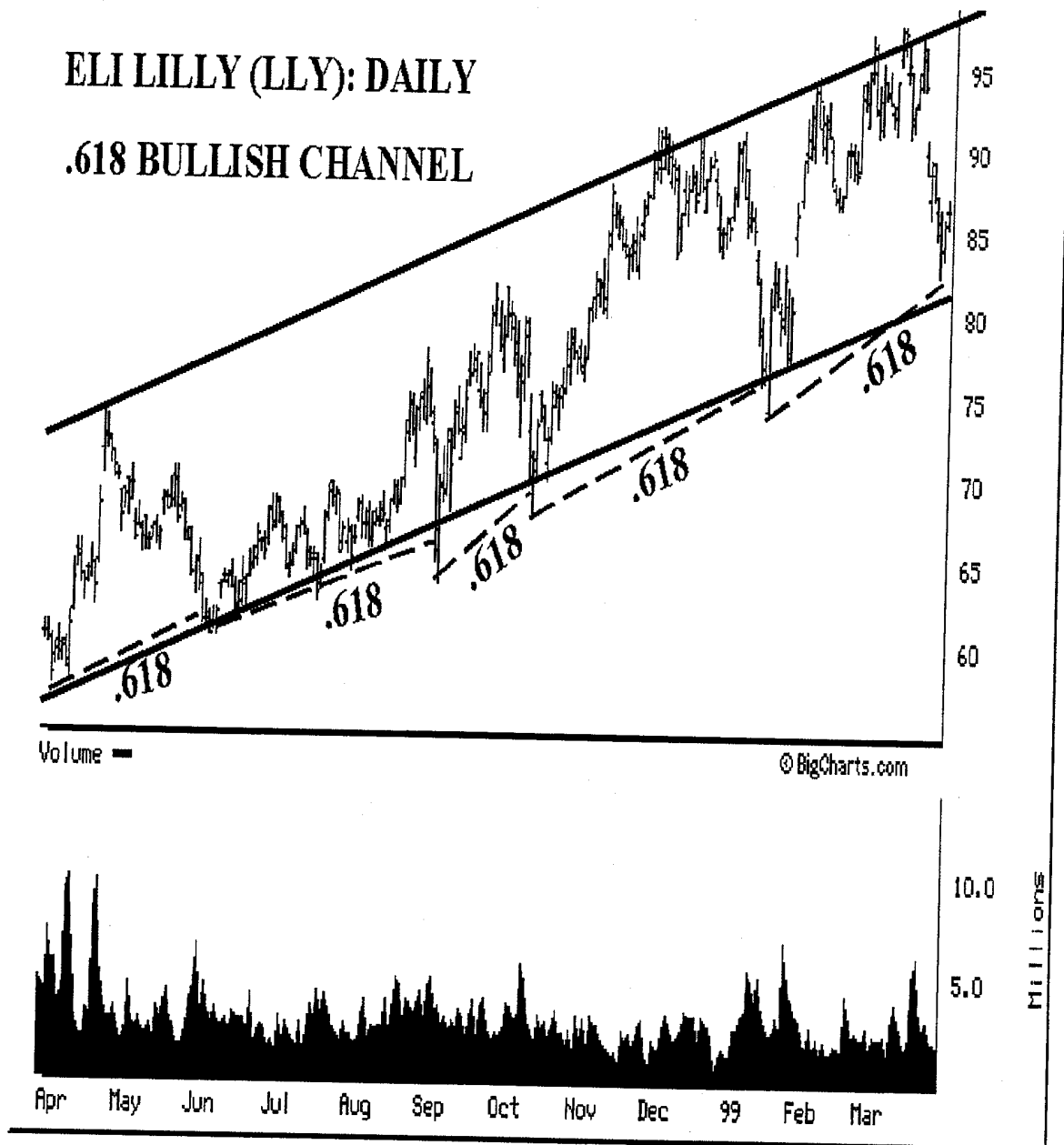

In this situation, since a .618 bullish channel has been observed, there is a high probability that the trend will continue. In fact, Eli Lilly provided five opportunities to capitalize on this set-up. The most recent retracement bounced off the .618 retracement of the prior rally, although it did not retest the lower range of the channel.

It is important to recognize repetitive price action such as this. As long as the stock holds the .618 retracement when it sells off, you know that the uptrend is intact. However, some type of breakdown past the .618 with a bearish continuation will signal that the trend is potentially reversing. Knowing the character of this type of price action can help you identify key turning points in the stock.

.618 Bearish Channel

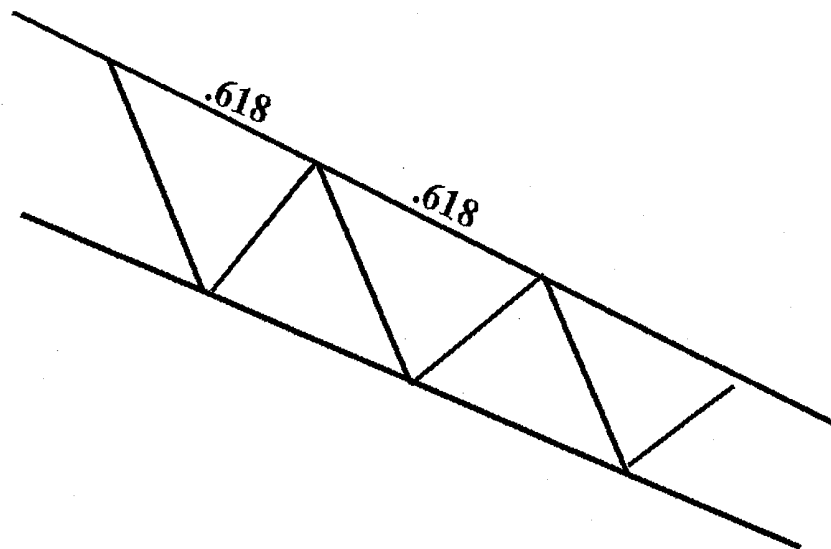

BEARISH CHANNEL: RESISTANCE AT .618 RETRACEMENTS

In a bearish channel, the .618 commonly acts as resistance of the prior sell-off. Similar to the bullish channel example, a stock that is in a clear downtrend that retraces off the .618 repetitively can provide high probability trade set-ups with very limited risk. Let's look at an example of this type of price action.

The following chart of Barrick Gold clearly illustrates a bearish downtrend that experiences significant resistance at the .618 retracement of the prior decline.

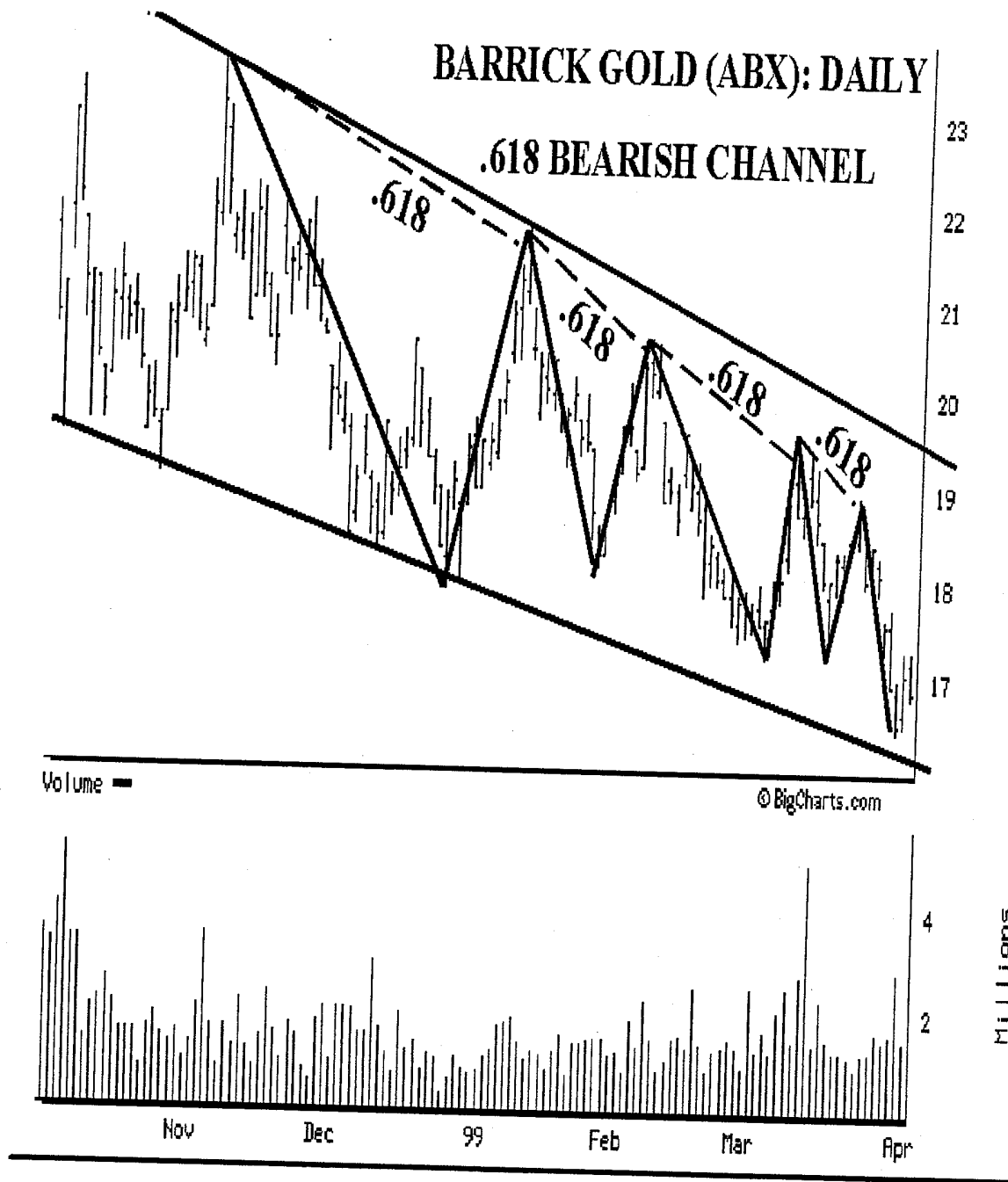

Does anyone see a pattern here? I think this is substantial evidence of the significance of the .618, especially in a repetitive trend. When the .618 acts as resistance in a trend, the price action can be very strong. The existence of this coil of .618 retracements indicates that this stock is very

influenced by Fibonacci numbers. Knowing this, I can assume that the numbers should accurately gauge the price action and identify potential opportunities in the future.

In this example, the .618 provided several opportunities of picking up at least a few points every time the stock bounced to retrace the .618 of the prior down leg. Quantifying and understanding the nature of such price action will greatly improve your executions.

.618 Retracement Summary

The .618 is a very effective Fibonacci number that reveals a great deal about the overall trend of a stock. The .618 retracement is the first area to examine for potential support when the stock is declining, and it is the first area to examine for potential resistance when the stock is rallying. Channels that develop with .618 retracements offer high probability trade set-ups that have a low risk. Also, most technicians are aware of the .618 - or as they like to tell the public, a two-thirds retracement. So, when a .618 reversal has occurred, it is my opinion that a greater amount of technical traders participating in that stock are aware of this price action. Hence, the .618 reversal point becomes an even more significant price point.

8

0.786 Retracement

The .786 retracement is the square root of the .618. The .786 retracement is the next critical area to examine, after the .618 has been clearly violated. The .786 is a vital Fibonacci number because it is often the “last chance reversal area” before retesting the original price point. Price action that does not reverse off the .786 usually will retest, and often break past the original starting point. Therefore, .786 failures are significant because the stop loss limit will be clearly defined by the original starting point and relatively small in comparison to the potential reversal.

The .786 retracement is fairly unknown in the industry, although I believe that more technicians are becoming aware of its significance. In my opinion, it is a crucial Fibonacci number, as it accurately determines a stock’s trend, based upon the price action at the number.

Another reason the .786 is a valuable Fibonacci number is because it can often gauge potential opportunities, especially when the surrounding “market noise (information)” suggests that the set-up is to be avoided. I have observed many situations, where the information in the media is quite contrary to what the price action at the .786 is indicating. If a stock is trending strongly, the .786 projection frequently can serve as a key reversal point, despite such contrary information. The following illustrations and examples will elucidate this concept.

Bullish .786 Retracement

When a stock is selling off after a rally, the .786 retracement often acts as important support. If a stock declines past the .786 retracement, it will usually retest the original starting point (pt. X) of that prior rally. Let's look at the illustration.

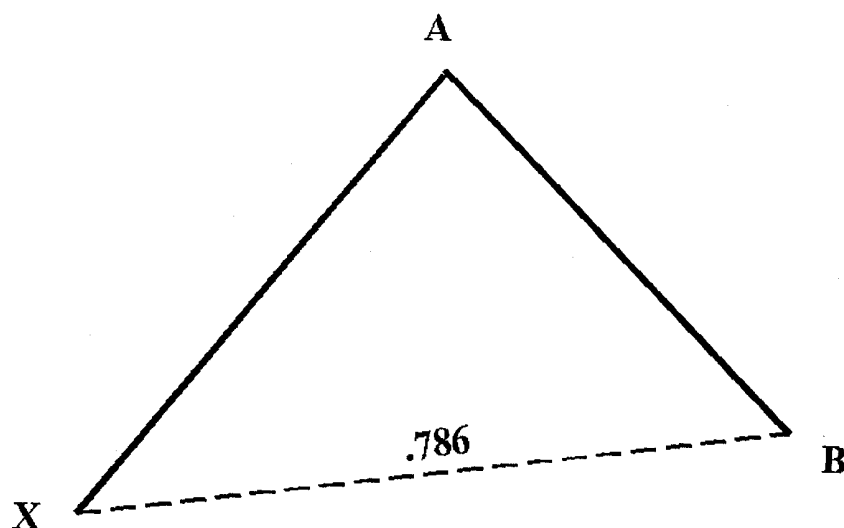

BULLISH .786 RETRACEMENT

BUY AT B!

The following examples will demonstrate the significance of the .786 retracement as important support in stocks that are selling off.

The first example is a daily chart of the Dow Industrials that is a great example of the .786 gauging extreme market action. Clearly, the Dow Industrials found support at the .786 from the prior year's panic low. The .786 was projected at approximately 7460 and the low for the Dow during this decline was approximately 7400. The Dow made several attempts to sell past this low point but the .786 support held together.

The Dow proceeded to rally 2500 points within the next six months! Although the newspaper headlines were extremely bearish at this time, the stock market made a significant bottom in the beginning of October, and it proved to be a very good time to be committing money to the market.

**DOW JONES INDUSTRIALS:
DAILY**

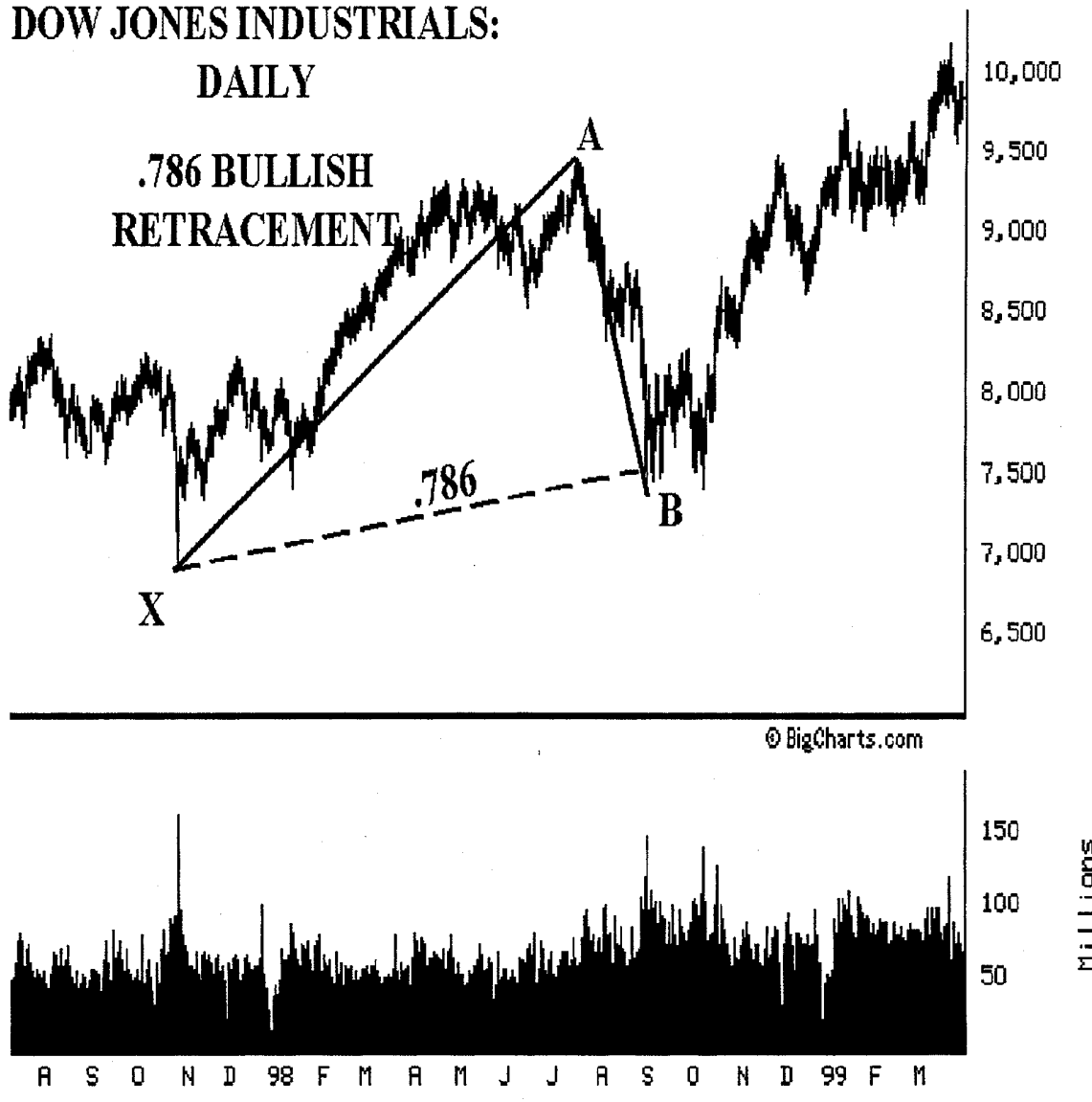

I have included an enlarged chart of the Dow Industrials to show the price action at the .618 and the .786 retracements. As you study this, it is important to notice how the Industrials acted after they hit these retracements. In the case of the .618, projected at approximately 7890, the Dow Industrials continued to decline in the days after it hit this price level. As for the .786, the Dow Industrials clearly found support.

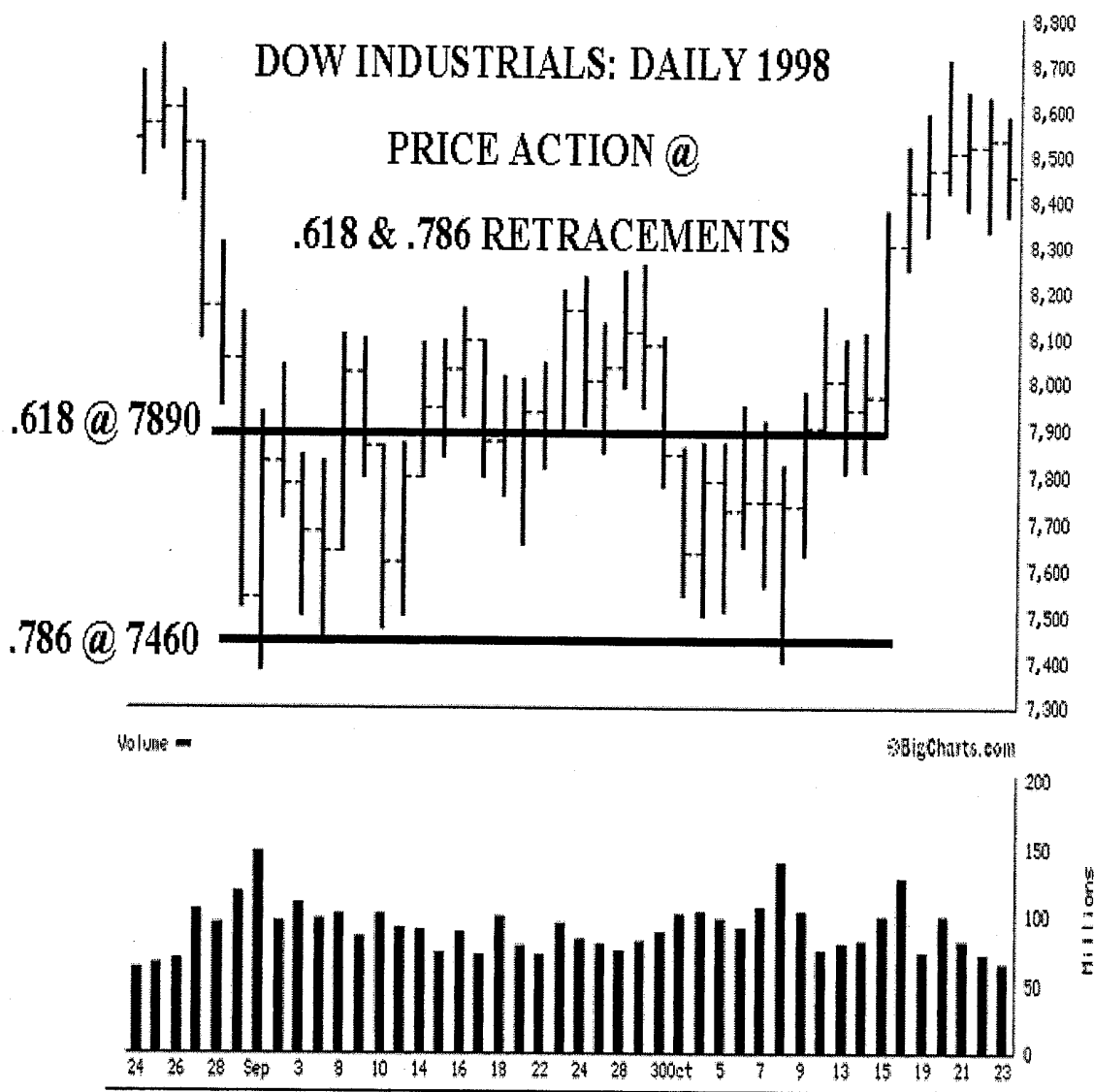

The major Fibonacci retracements of the .618 and the .786 from the prior year's low proved very accurate in gauging the price action. The .618, which was just below 7900, was obviously "blown out" by a strong sell-off. However, the Dow Industrials found good support at the .786 and reversed nicely from this area. Even if you waited for a clear reversal, the support at the .786 indicated that the Dow Industrials established a bottom and that a new uptrend was in place.

These declines will happen again! The stock market will provide you with opportunities like this one in the future. When these situations occur in the future, you must realize their significance and take advantage of these opportunities.

During the market's decline in the fall of 1998, Disney also suffered a serious beating. The stock was cut in half in less than six months. This weekly chart illustrates the significance of the .786 retracement. The stock reversed off the .786 retracement from a critical low in July 1997 at 17 3/4 (pt. X) to a high in July 1998 at around 42 1/2 (pt. A). Disney declined and then reversed almost exactly at the .786. The .786 was calculated at 23 1/16. Disney declined to 22 1/2 (pt. B) and rallied over 15 points during the next few months.

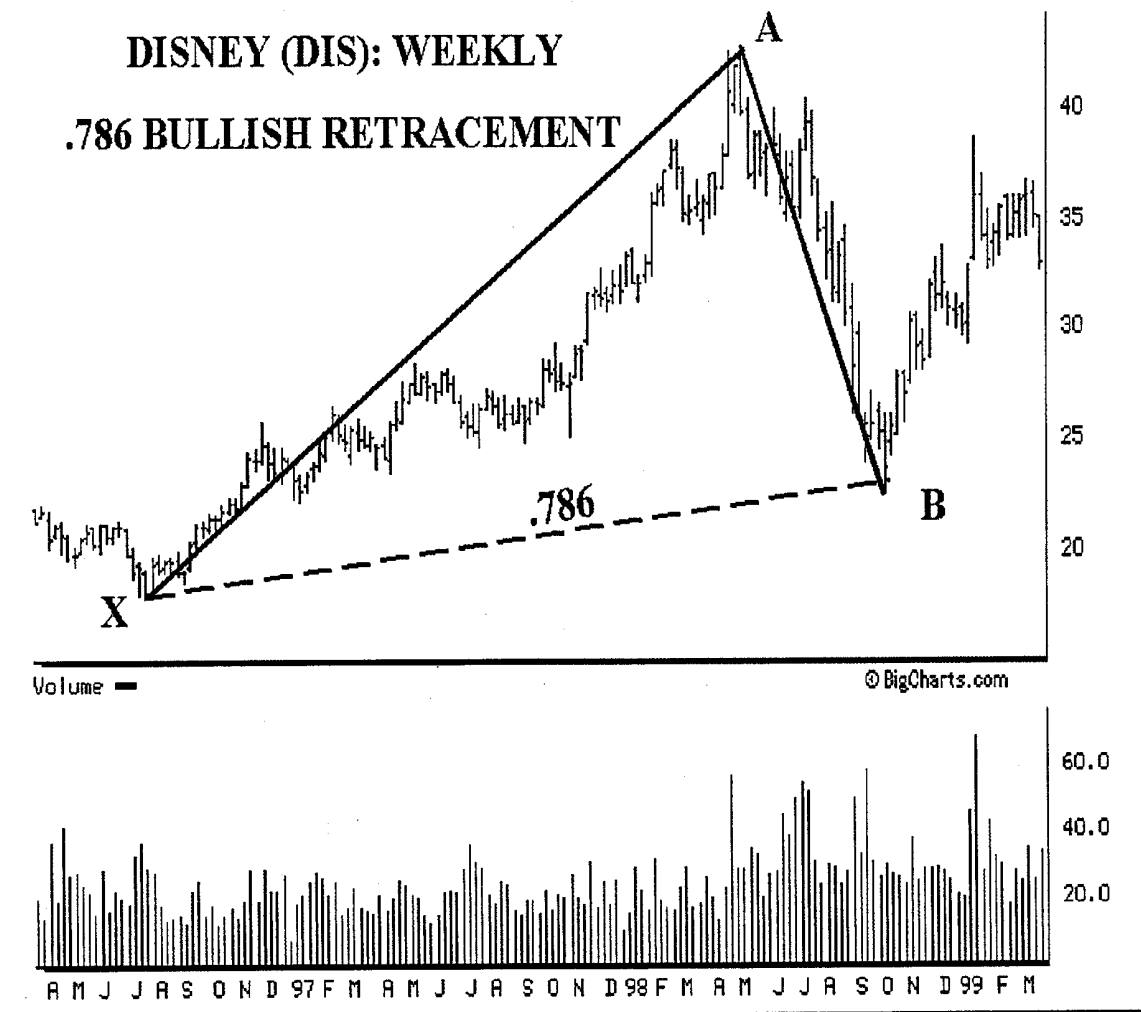

On the week Disney hit the .786, the price action clearly indicated a reversal at hand. The reversal was confirmed, since the following week started an uptrend that led to a nice rally over the following several months. You might be wondering (again) how you would know to utilize the .786 as an entry point rather than the .618. I have included an enlarged chart to illustrate the price action at the .618 and the .786.

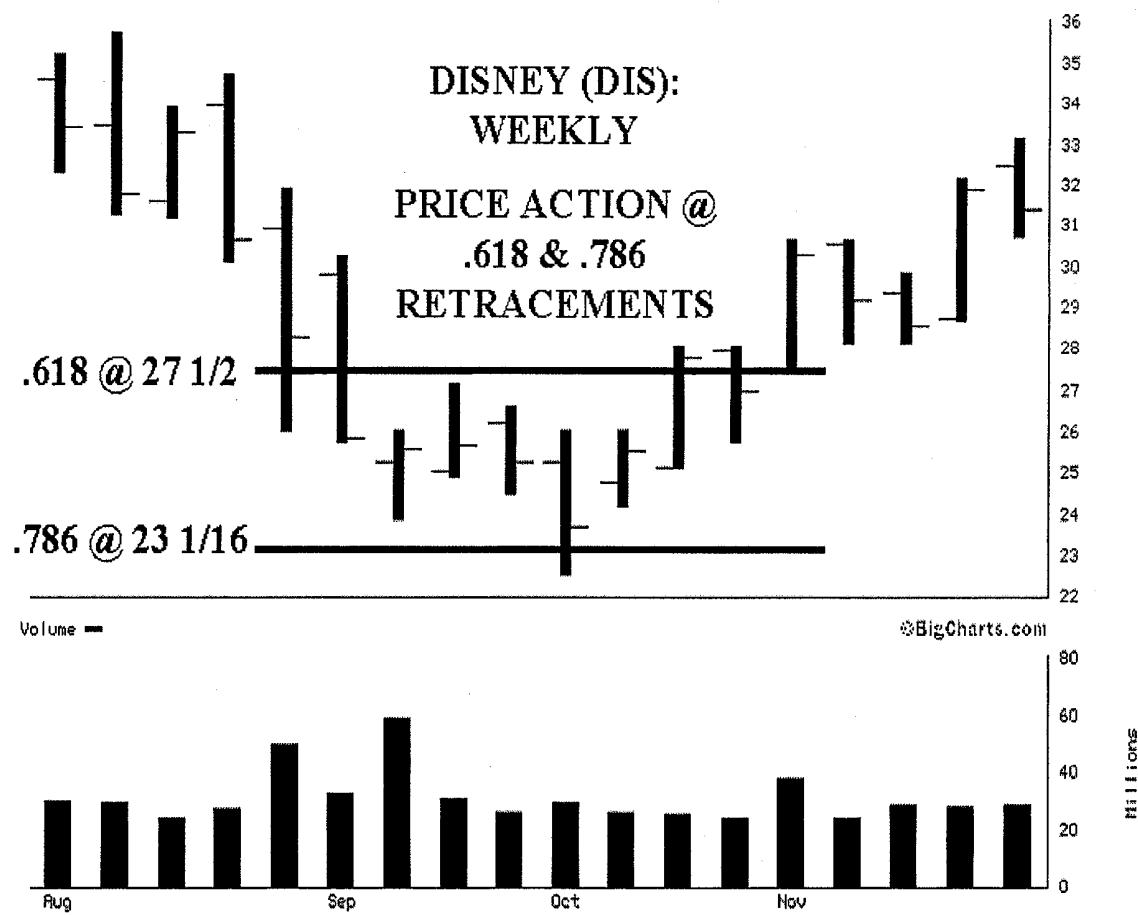

As you can clearly see, the stock sold off sharply past the .618, which was projected at 27 1/4. On the week that Disney hit this number, the selling was quite strong, as evidenced by the extreme price range. Such an extreme decline is a warning sign that the Fibonacci projection is probably not a good point to buy. At a minimum, when a warning sign is observed at a Fibonacci number, you should wait one price bar. In this case, the stock continued to decline the following week.

The stock did begin to reverse after hitting the .786 retracement. The reversal was confirmed the following week, as the stock gapped up on the open and finished with a bullish close. The reversal was confirmed further by the next week, when the stock broke above the previous two weeks' highs and closed very strongly.

This is a great chart to study because the stock bounced almost exactly off the .786 retracement. Such harmonic action is no coincidence, as this example of Disney truly validates the use of Fibonacci numbers in gauging price action.

Bearish .786 Retracement

The .786 retracement can act as a "last chance" resistance point before retesting the previous high. It is a very key area because stocks that reverse off a .786 retracement of a prior high usually indicate weakness in the price action. Let's look at the illustration.

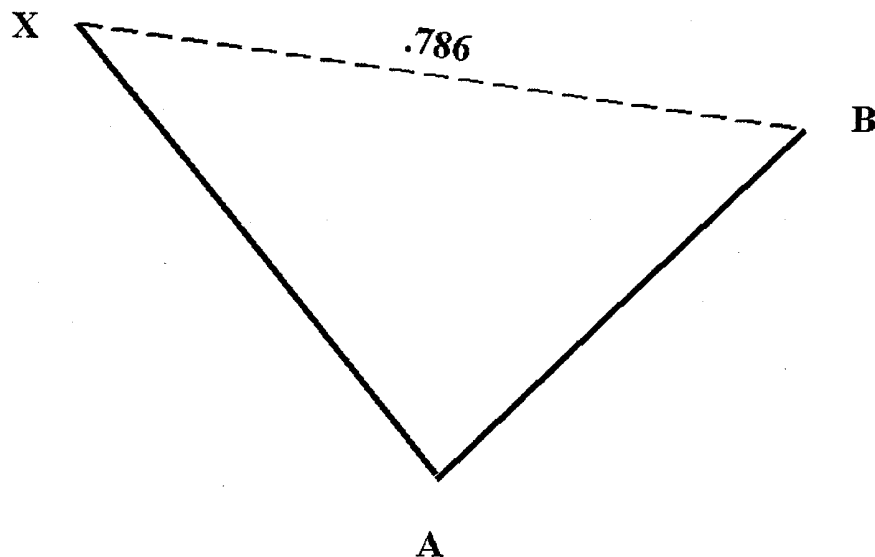

BEARISH .786 RETRACEMENT

SELL AT B!

When a stock is rallying especially after a substantial decline, the .786 is an important projection point. In my opinion, a stock that can break through the .786 retracement usually will retest the previous high. However, if a stock can not rally above this point, the ensuing reversal can be quite significant. Let's look at some examples, as they will clearly illustrate the concept.

The following chart of America Online is a fantastic example of resistance at a .786 retracement. Although the stock exceeded the projection slightly, AOL had tremendous difficulty rallying through this retracement.

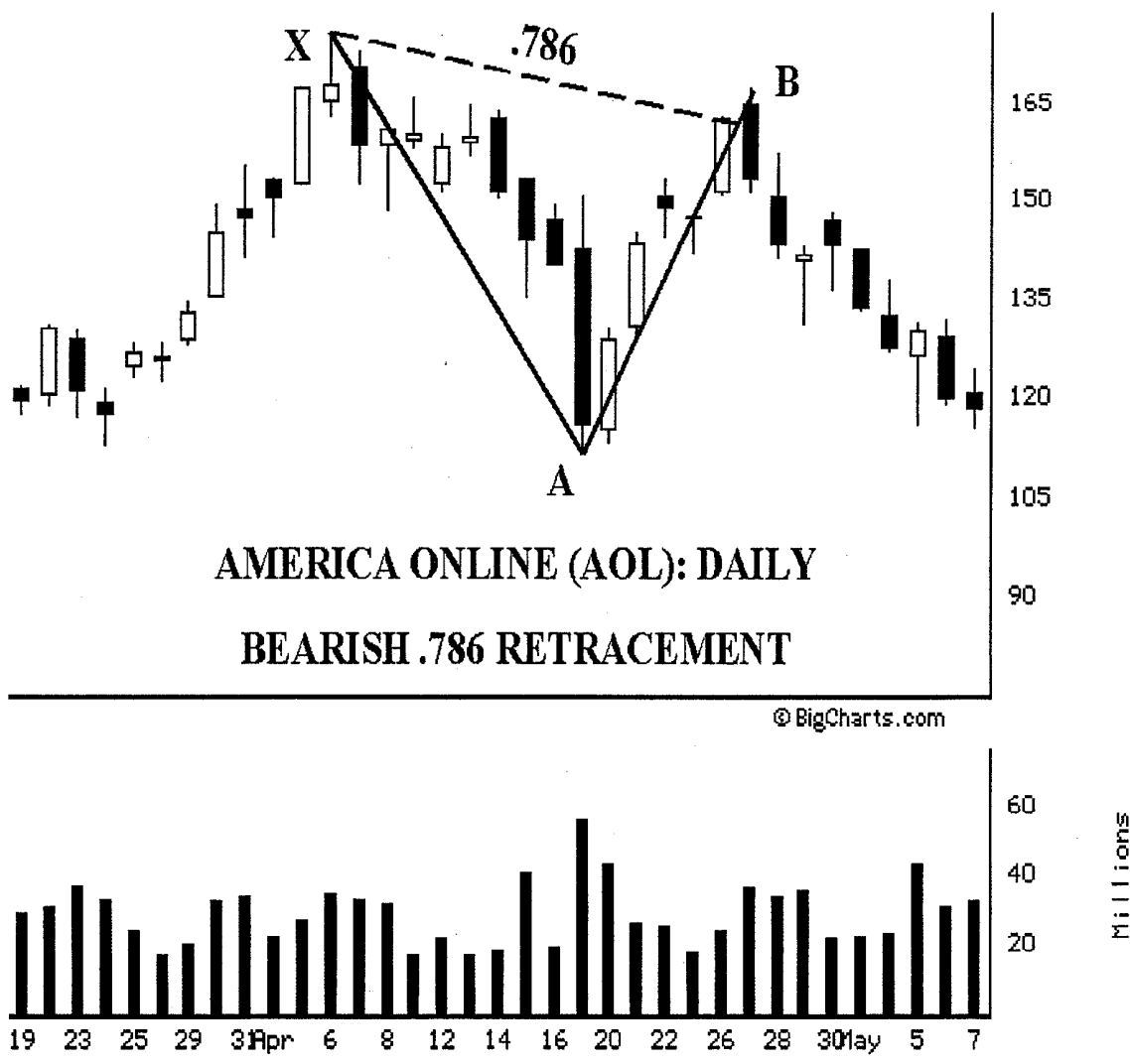

Despite the extreme volatility, AOL clearly reversed after hitting the .786 retracement. From the early April high at 175 1/2 (pt. X) to the following low at 112 (pt. A), the stock bounced and reversed just past the .786. The .786 retracement was projected at 161 15/16 and AOL reversed after hitting 167 1/8 (pt. B).

This might have been a difficult execution to gauge. The day before the stock reversed, it hit the .786 and even closed near the high of the day. Also, on this day, the stock gapped up on the open several points. Since these warning signs occurred at an important Fibonacci number, the trade

should have been avoided on this day. Despite this price action, the stock could not follow through on the upside, and America Online clearly reversed the following day.

When a stock can not continue its rally through the .786, as this example of AOL demonstrates, you must regard this action as bearish. This is especially significant, since the stock formed an extremely bearish candlestick the day after hitting the .786. If the stock was going to rally higher, the price action should continue to move up, forming higher highs and higher lows. Also, another bullish indication would have been a close above the .786 on the following day.

America Online could not continue its rally. So, if you waited a day, the clear reversal bar would have indicated that the .786 was indeed acting as strong resistance. Your patience would have been rewarded, as AOL declined over 30 points in the next few days after the reversal occurred.

The next chart of 3Com is another example of a stock that sold off sharply after almost exactly hitting a Fibonacci retracement. 3Com experienced significant resistance at the .786.

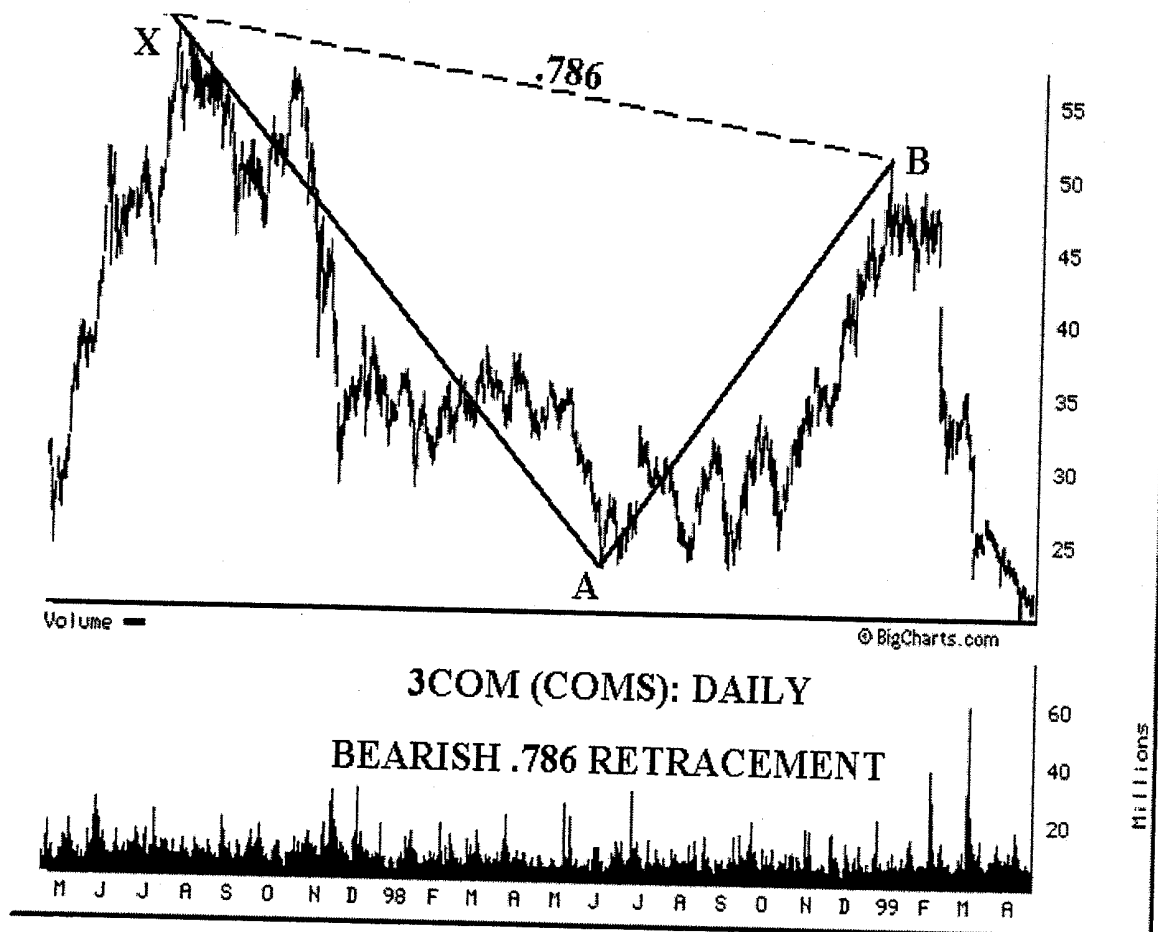

It is important to note, however, that the stock did not reach the exact .786 retracement. 3Com reversed at 51 1/8, while the retracement was calculated at 51 7/8. I would prefer to have seen the stock hit the .786 before entering a trade. But, this price action is so close to the retracement that I would consider it valid. I am sure at this point your next question is: how do you know? Referring to the chart, 3Com could not continue its rally after falling 3/4 of a point shy of the projection. In fact, the stock started to seriously break down several days after the reversal.

When a stock does not rally through a major Fibonacci retracement, as this example of 3Com demonstrates, this should indicate substantial resistance in this area. The stock moved sideways for over a month without even challenging the reversal high. Even if you were still in the stock, the major decline that occurred in the beginning of February 1999 would have confirmed that the new downtrend was in place.

.786 Retracement Summary

In summary, the .786 is a very significant Fibonacci retracement. When a stock is declining, it is a critical area for support before retesting the initial bottom. When a stock is rallying and attempting to retest a recent high, the retracement can act as significant resistance. The key to gauging the .786 as a potential reversal point is to study the price action at the .786 number and assess the following move. The price action around the .786 can provide substantial information regarding the potential future of a stock. Although the .786 is relatively unknown in the investment industry, it is an extremely effective gauge of a stock's price action.

9

1.27 Projection

The 1.27 is an important primary Fibonacci number for several reasons. It is first area to examine after a stock has moved beyond a significant previous point of resistance or support. In the case of a break out, the 1.27 projection is the first area to either take profits or enter a short position. In the case of a break down, it is the first area for potential support, covering a short position or entering a long position. The 1.27 is the square root of 1.618.

Similar to the .786, the use of the 1.27 projection is relatively unknown in the technical community. In my opinion, the existence of the 1.27 in harmonic patterns serves as a minimum requirement for many trade set-ups to be valid. Although the 1.27 projection is not as well known by technical traders, reversals off the number occur as frequently as the 1.618. Using this retracement will improve your ability to gauge price action and will help you discover more trading opportunities.

Bullish 1.27 Projection

The bullish 1.27 projection is an important area to look for potential trade set-ups. When a stock breaks down past its initial starting point (at X), the 1.27 projection is the first place to look for potential support.

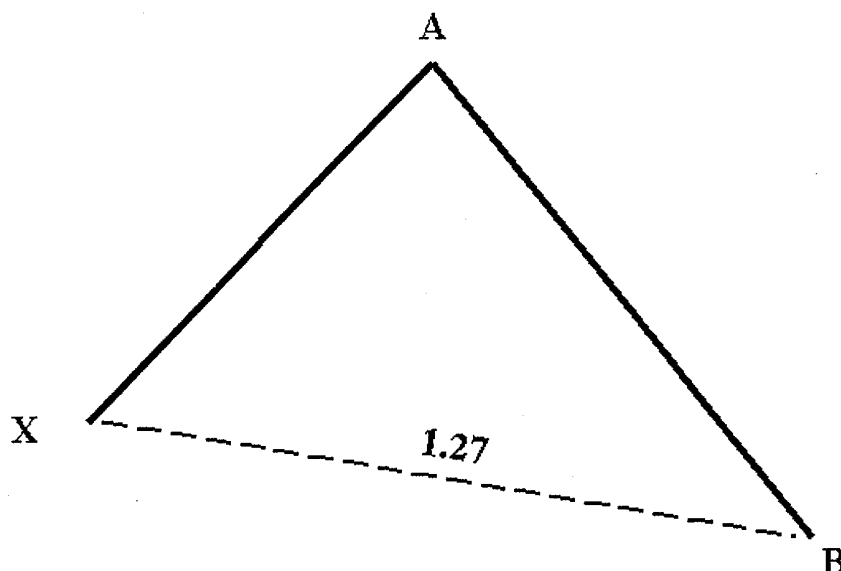

BULLISH 1.27 PROJECTION BUY AT B!

Let's look at some examples, as they will clearly illustrate the importance of the number.

The following weekly chart of Texaco illustrates the 1.27, as a nice area for support. Texaco reversed off almost exactly off this 1.27 projection. The 1.27 projection was calculated at 44 13/16, and the stock reversed at 44 9/16. Also, Texaco reversed on the week it hit the projection.

This projection developed over a year in duration. After the stock broke down past the previous low (pt. X), Texaco accelerated on the downside. Despite this decline, the stock bounced sharply off the 1.27 projection.

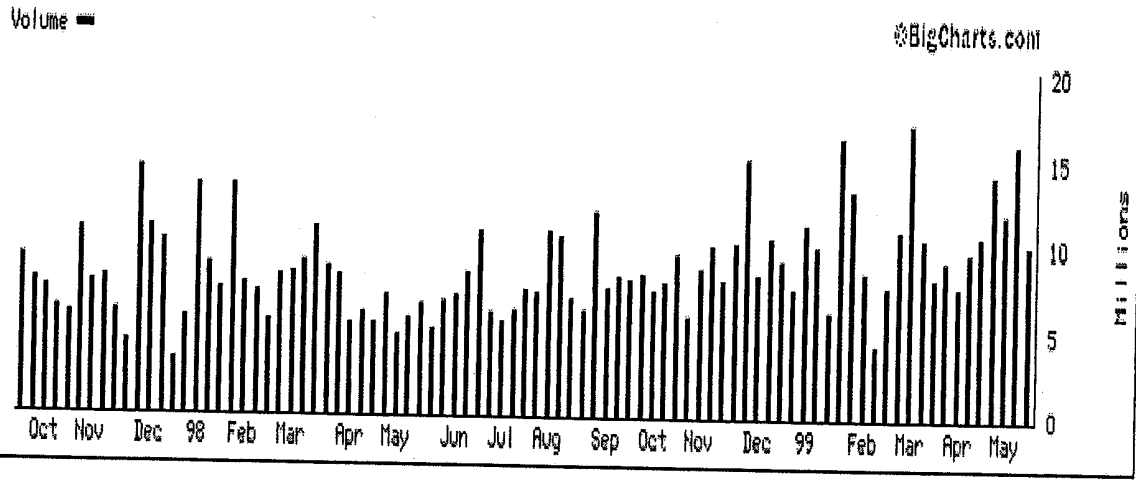
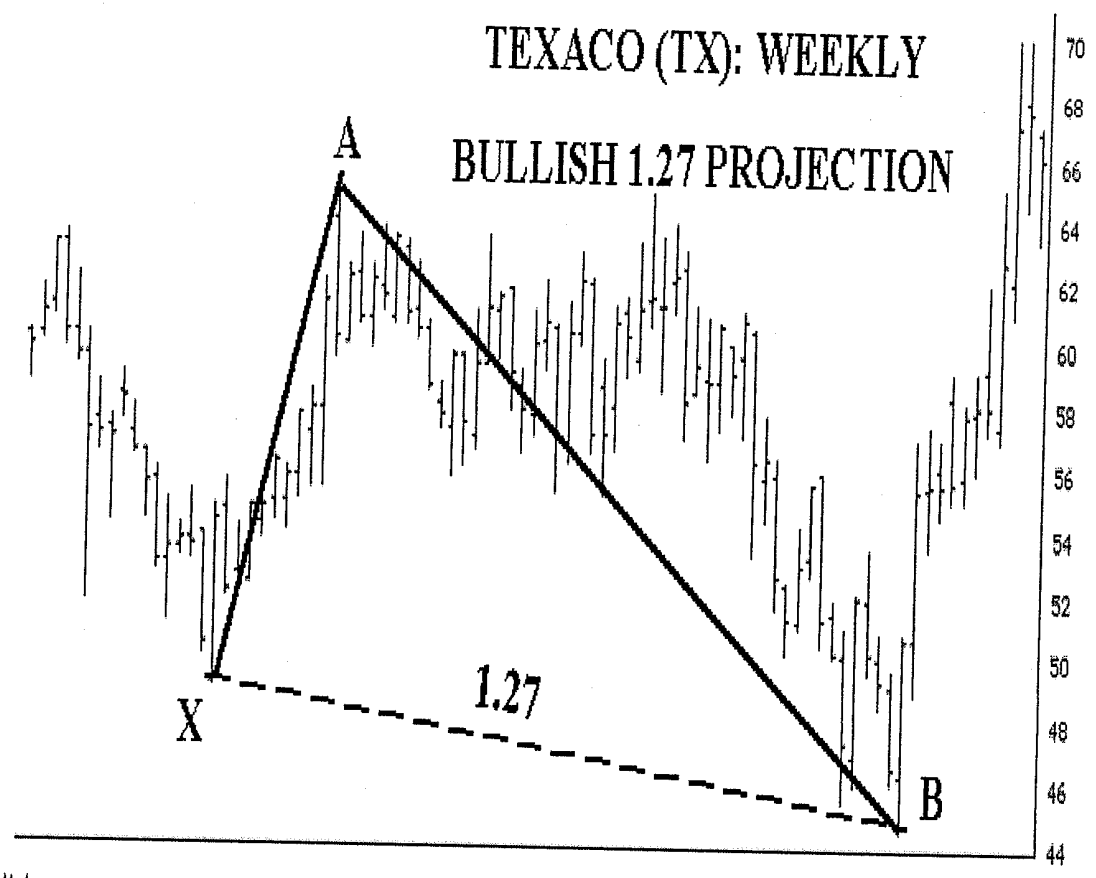

Not only did Texaco bounce on the week it hit the 1.27 projection, it reversed on the exact day. I have included an enlarged daily chart to illustrate the price action at the 1.27 projection. As you can see, Texaco literally bounced off this area, and the stock provided clear bullish signals to

confirm the reversal. Although the stock formed a bearish price bar on the day it hit the 1.27, the following three days signaled a new uptrend. The gap up on the open on the third day was overwhelming evidence of this new bullish trend.

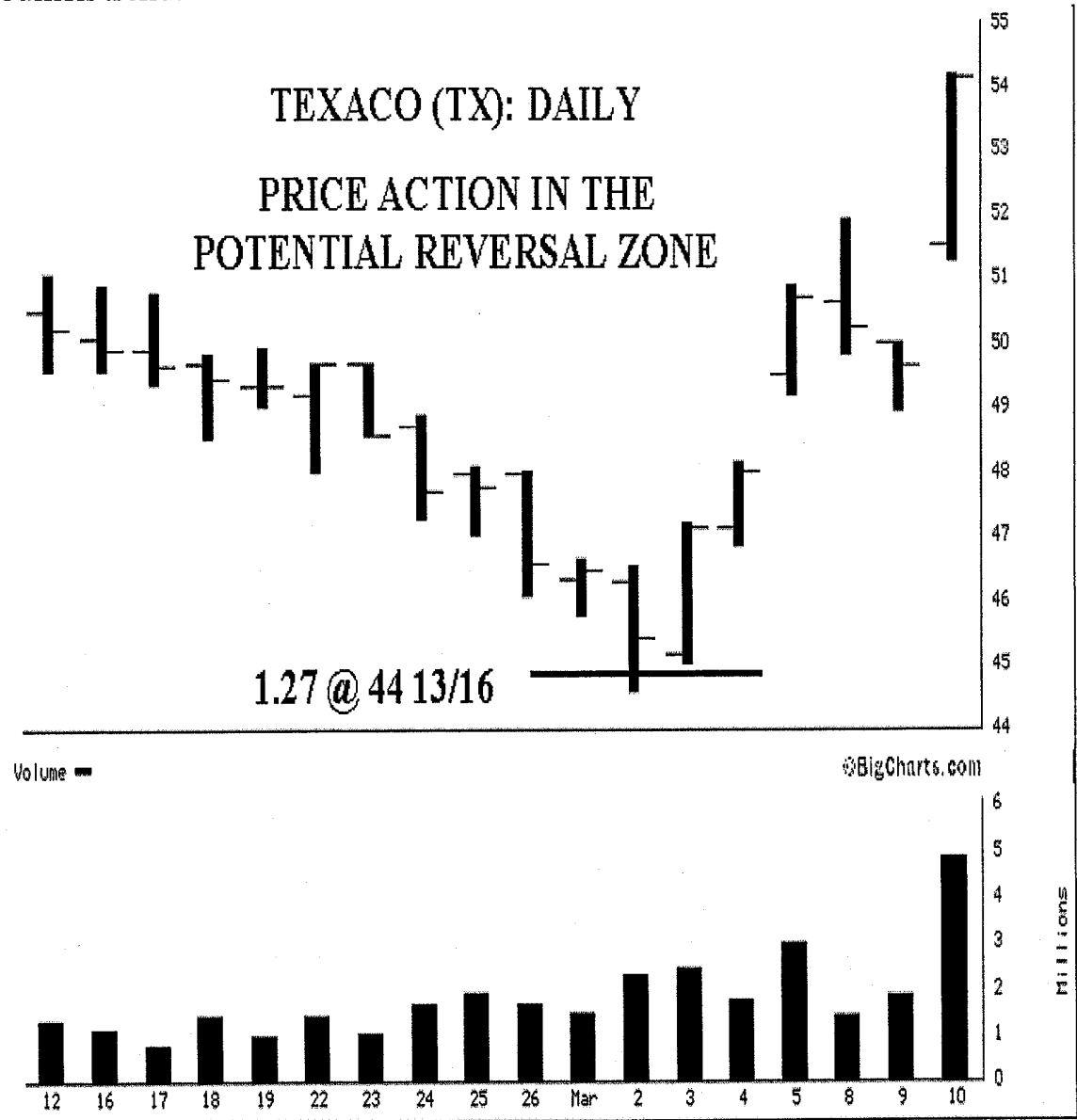

It is important to note that when a stock does reverse almost exactly off a Fibonacci projection, the price action can be strong. In this case, Texaco rallied almost 25 points in the following few months.

The next chart is another great example of the 1.27, acting as support. JC Penney reversed within a point, after exceeding the projection. The 1.27 was calculated at 36 9/16. The stock hit 35 3/8 and reversed.

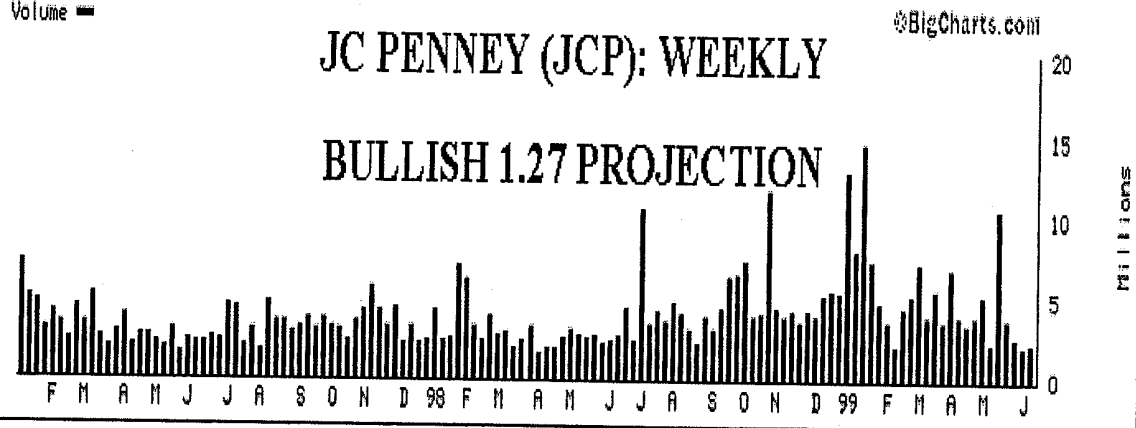
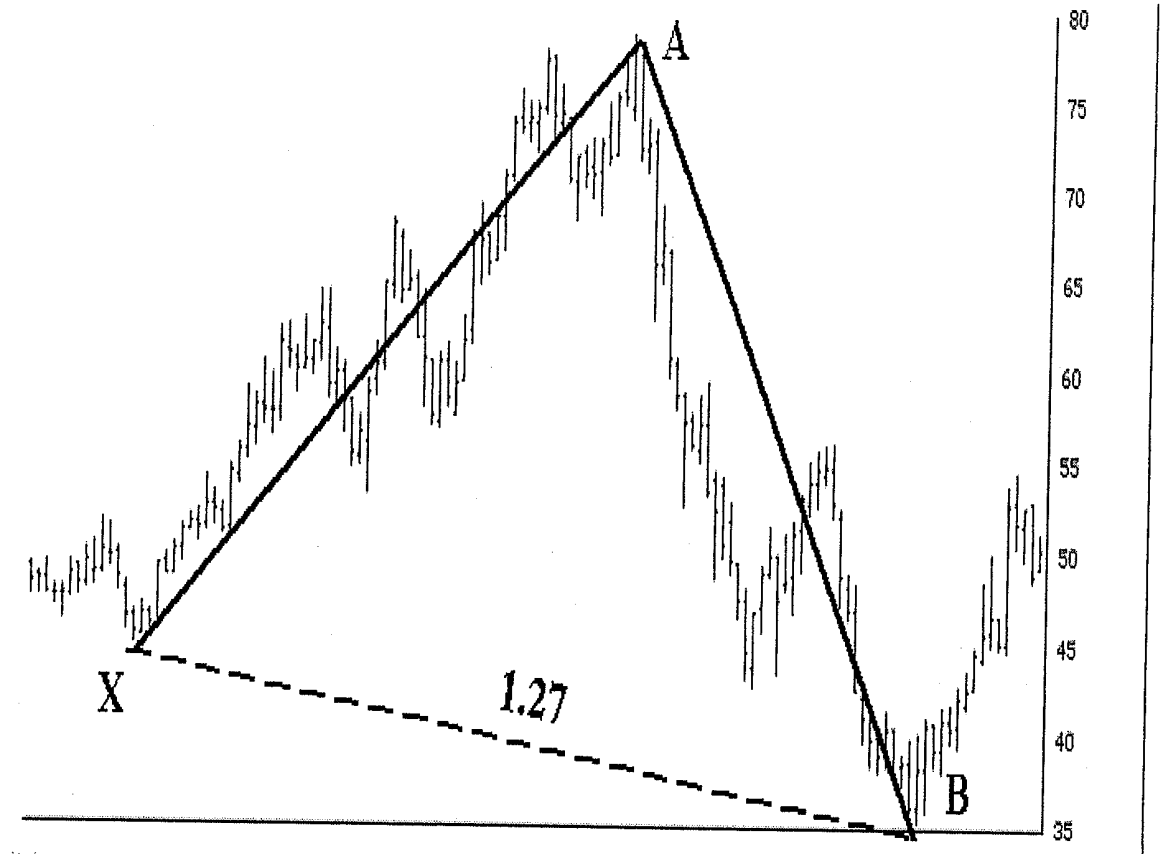

The next enlarged daily chart shows how JC Penney found significant support at this 1.27 projection. After moving sideways for several days, the stock provided clear signals of a new uptrend. As you can see, the stock found excellent support at the 1.27 projection. Since the stock possessed a bearish price bar on the day it hit the projection, you might have waited for some clear reversal signals. Four days after hitting this area, the stock rallied strongly.

JC PENNEY (JCP): DAILY

PRICE ACTION @ 1.27 PROJECTION

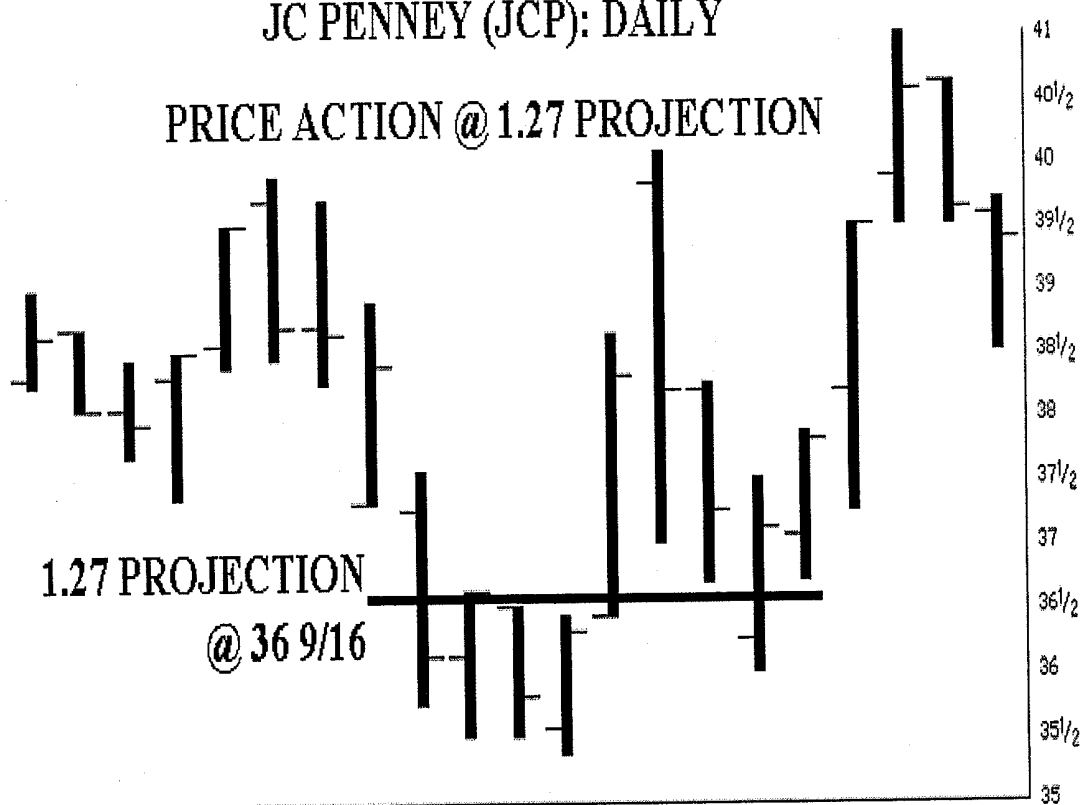

Volume

BigCharts.com

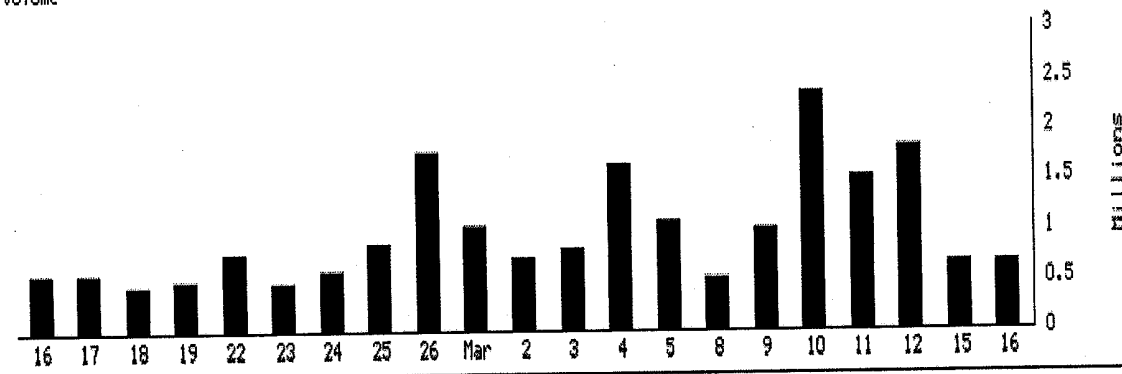

It is price action like this that is truly astounding. JC Penney sold off from a high around $78 \frac{3}{8}$ and lost more than half of its value in nine months. The stock sold off slightly past the 1.27 and reversed. The 1.27 projection served as significant support, as JC Penney rallied nearly 20 points within the next few months after reversing.

Bearish 1.27 Projection

The bearish 1.27 is an important Fibonacci projection. After a stock has broken above a previous high, the 1.27 is the first area I look at for potential resistance. Let's look at the illustration.

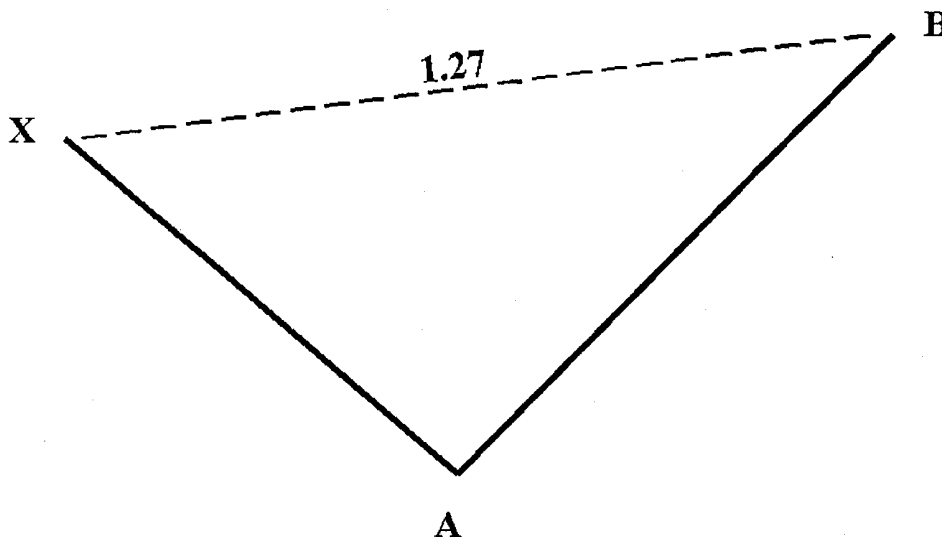

BEARISH 1.27 PROJECTION SELL AT B!

After a stock breaks out above a previous high, it is easy to believe the rally will continue for a while. Quite frequently, a stock will experience resistance above the break out point at the 1.27 and not yield much of a rally. Therefore, the bearish 1.27 is an important price area to examine to determine the strength of a breakout. Let's look at some examples, as they will illustrate the concept.

The following chart of Broadcast.com shows how the 1.27 can act as substantial resistance. In this example, the stock reversed after exceeding the 1.27 projection of the prior decline. The reversal was confirmed by the bearish price bar, which materialized the day the stock hit the 1.27 projection. Although the 1.27 was exceeded, the stock reversed on the day it

hit the projection. So, even if you waited one day, the stock was clearly heading down, as the following day ended with an extremely bearish close.

When a stock reverses at a major Fibonacci like the 1.27, the price action must be examined closely. In this example, Broadcast.com reversed sharply after hitting the projection. The 1.27 was calculated at 170 1/8, while the stock topped out at 177 1/4. In fact, the stock reversed on the day that it hit the projection.

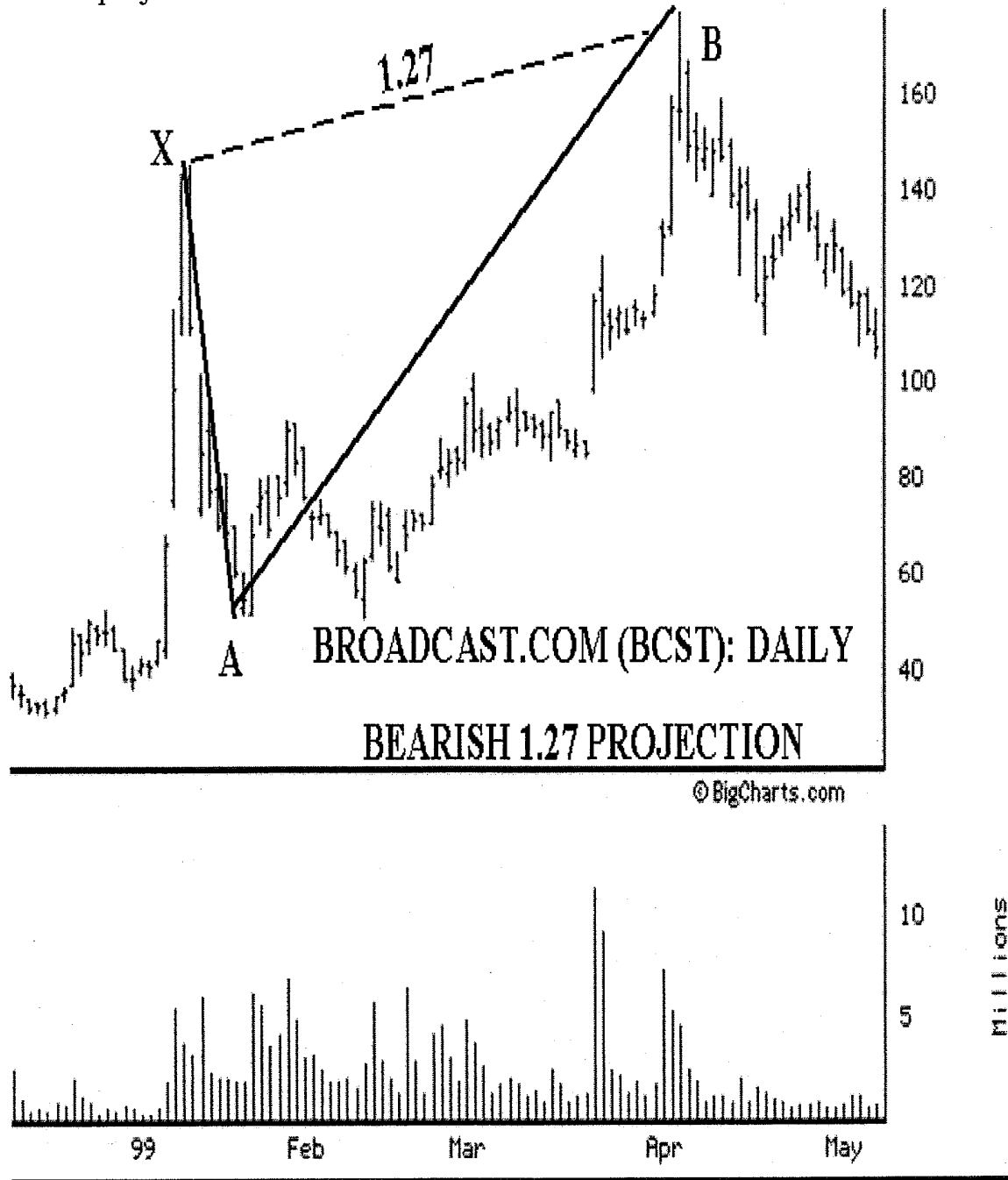

An interesting aspect of this reversal is that the stock finished the day unchanged on the day. This price bar pattern is known as a doji in candlestick terms. Since the price action was very extreme on this day, you probably should have waited a day. However, such a price bar should indicate a potential reversal at hand, especially after hitting a major Fibonacci projection.

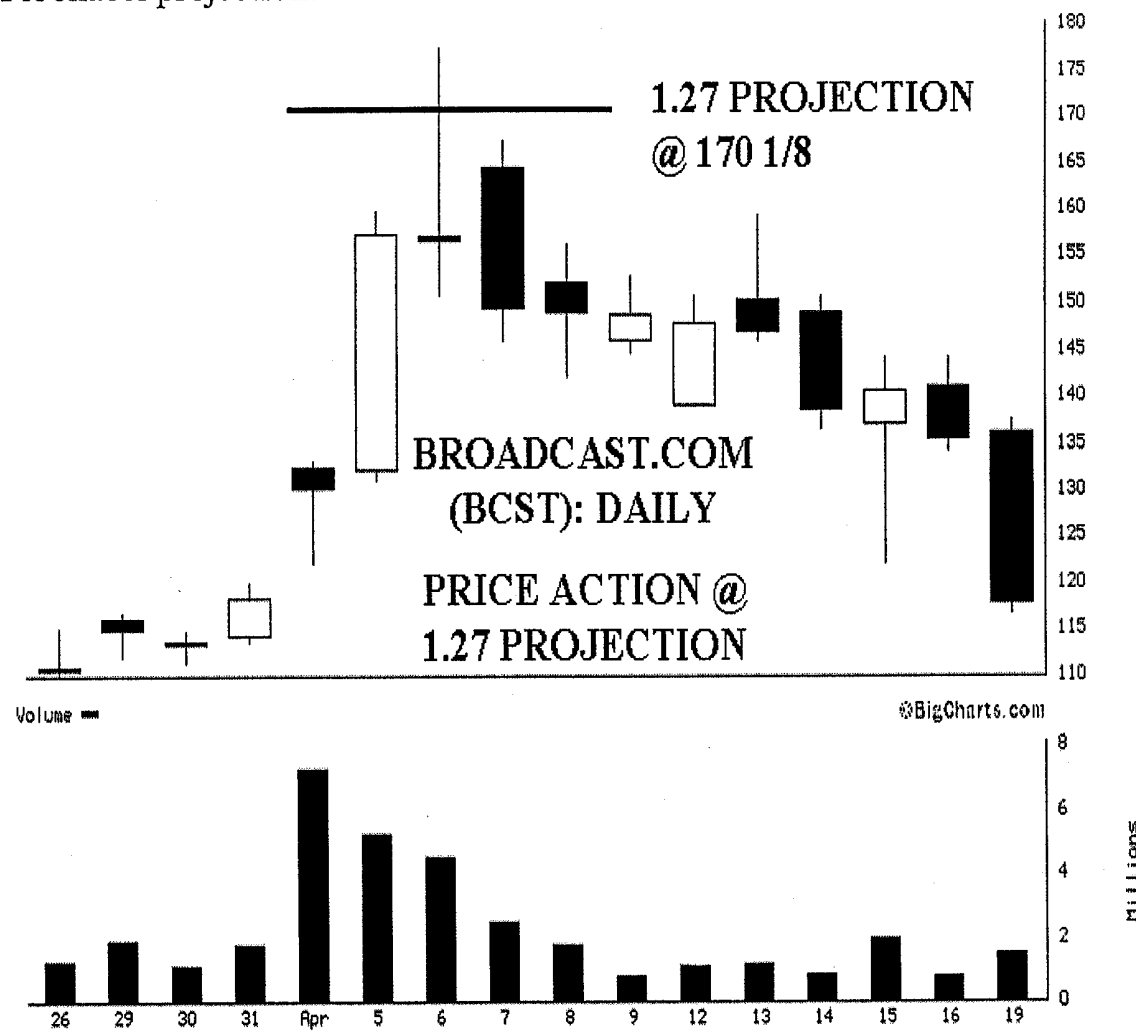

This enlarged chart clearly shows the price action at the 1.27 and the doji that formed on that day. It is also important to notice that the stock clearly broke down after the reversal was complete, as Broadcast.com made new lows and could not break above the previous day's high. In fact, the stock sold off sharply four days in a row after hitting the 1.27 projection. So, even if you waited a day, the price action clearly confirmed the new downtrend. Broadcast.com lost almost 70 points within two months.

This next chart of The Globe.com is another excellent example of the 1.27 as resistance. The stock reversed almost exactly at the 1.27 projection. The 1.27 was calculated at $42 \frac{5}{16}$, and The Globe.com reversed at $42 \frac{3}{4}$! This is truly amazing, especially since the stock rallied so sharply on this day. In fact, the stock was up nearly 15 points.

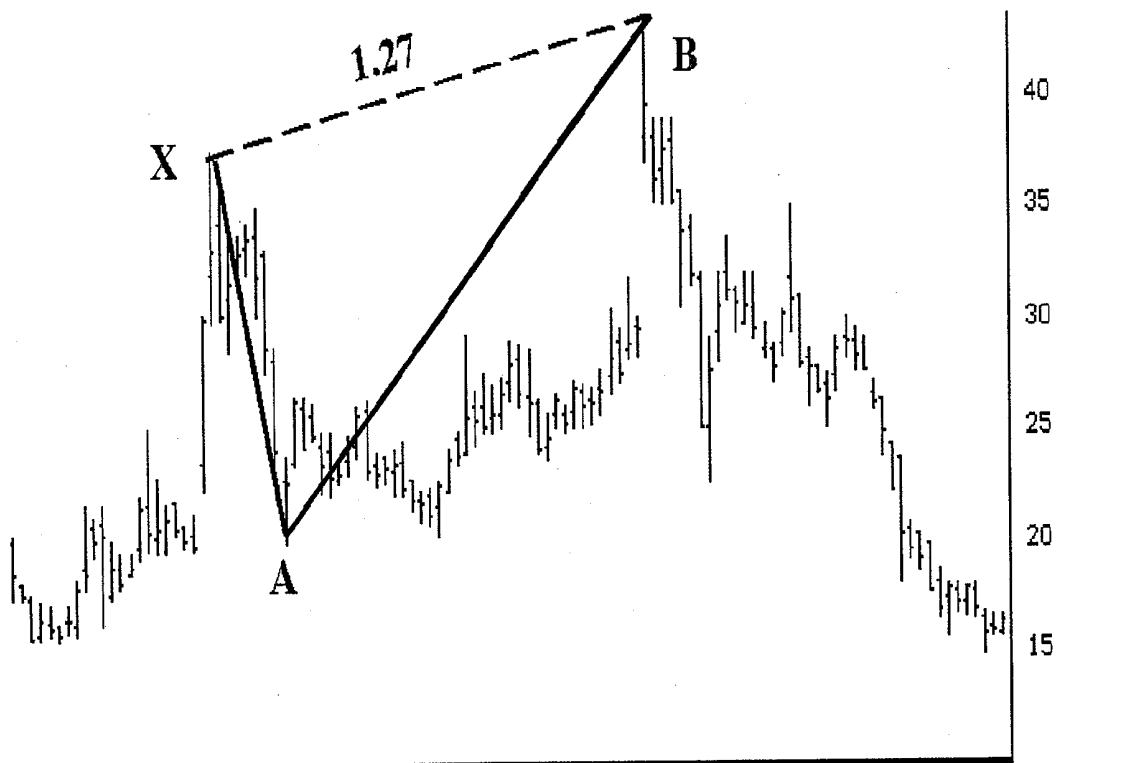

© BigCharts.com

**THE GLOBE.COM (TGLO): DAILY
BEARISH 1.27 PROJECTION**

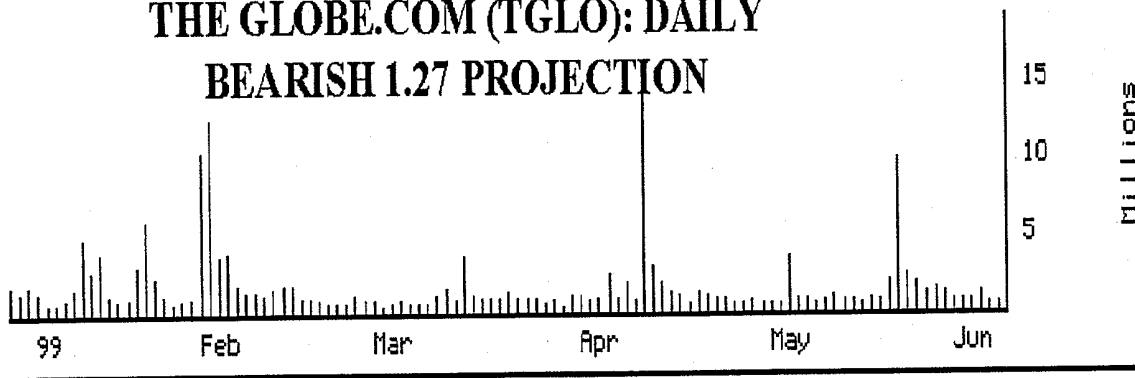

Since the stock was up so much on this day, you should have waited to see the following price action. Clearly, the stock was over-extended, as it started to sell off the next day. Within a few days after the reversal, the stock sold off sharply and lost 40% of its value.

1.27 Channel

Similar to the .618, the 1.27 often occurs repetitively in channels acting as a significant reversal point. Stocks frequently trade in a defined range with a consistent slope. In the case of an uptrend, very often, the 1.27 will usually be located at the upper range of the trend channel. In this instance, the 1.27 can be an ideal place to take some short-term profits. In a downtrend, the 1.27 projection can be used to for a short-term buy or cover a short position at the lower range of the channel.

1.27 Bullish Channel

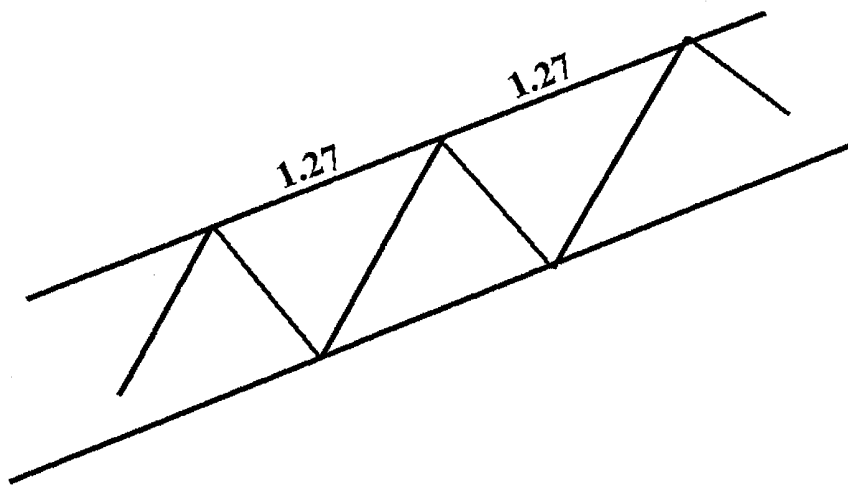

**BULLISH CHANNEL:
RESISTANCE AT 1.27 PROJECTION**

In a bullish channel, the 1.27 Fibonacci projection of a prior decline very frequently can act as a resistance point. When such repetitive price action is identified, the 1.27 and the upper range of the trend channel can serve as a potential trade opportunity.

Although this seems like a simplistic diagram, price action frequently resembles this illustration. The combination of the trend channel and the Fibonacci projections can clearly indicate important reversal points for a stock. The next example will illustrate this set-up.

The following chart shows that Seagrams definitely established a clear uptrend channel. This three-year chart shows that the stock found great resistance each time the stock rallied up to the upper range of the trend line and the 1.27 projection of the prior decline. One of the most incredible aspects of this chart is that the price action formed this bullish channel over a four-year period.

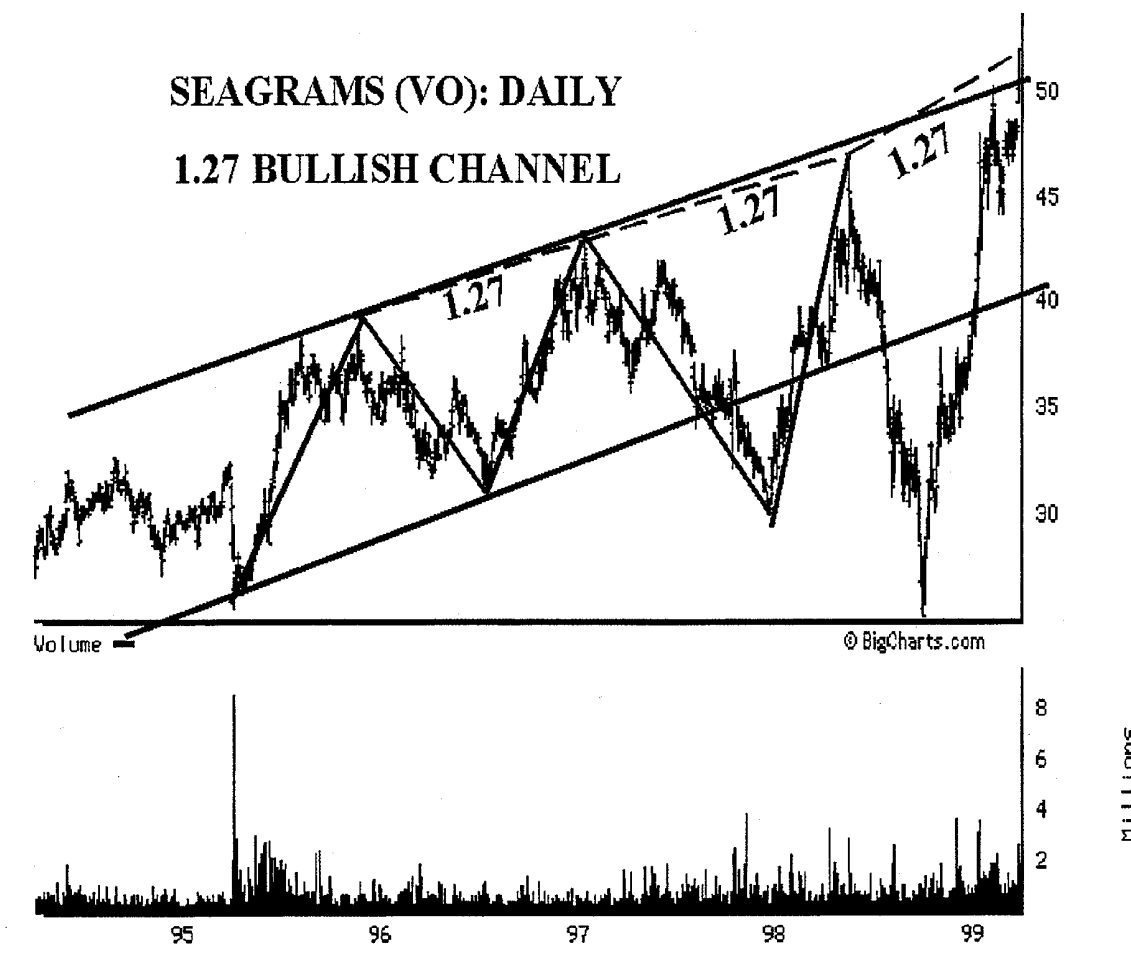

If you owned this stock and was aware of such cyclical price action, what would you do when the stock hit the 1.27? Hopefully, you would understand the significance of this price action, and take profits or short the stock, when it tested this area.

The trend line adds to the resistance that the stock experienced. But, what if the trend was not going to reverse off the upper range of the trend line and breakout? How would you know? The price action would usually indicate such a move through the warning signs of a price gap, tail close or extreme price range.

The next chart illustrates such a breakout. I have included this chart of a major breakout that Seagrams experienced. The stock clearly broke through the upper channel and the 1.27 resistance levels. When this occurred, the stock rallied sharply.

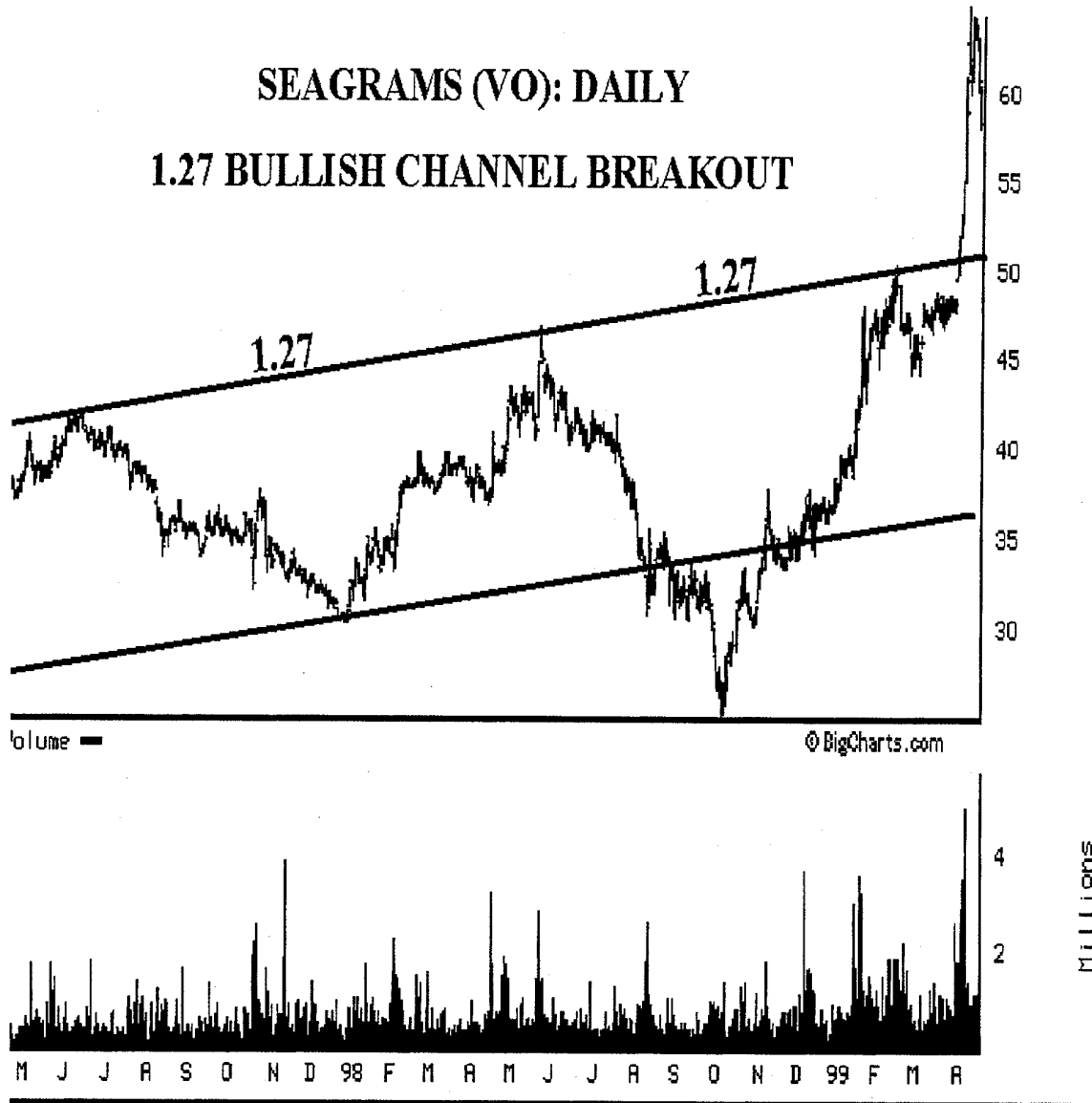

Since the bullish channel existed for over four years, this break out is especially significant. The stock rallied impressively, as it climbed nearly fifteen points with a few weeks after the breakout. Such price action is very significant, since it represents a dramatic change in mass perception with the stock.

1.27 Bearish Channel

The 1.27 Fibonacci projection can be found as support in bearish channels as well. The bearish channel will form a defined range with a consistent negative slope. In this situation, the trade opportunity can be defined by the 1.27 projection and the lower range of the channel.

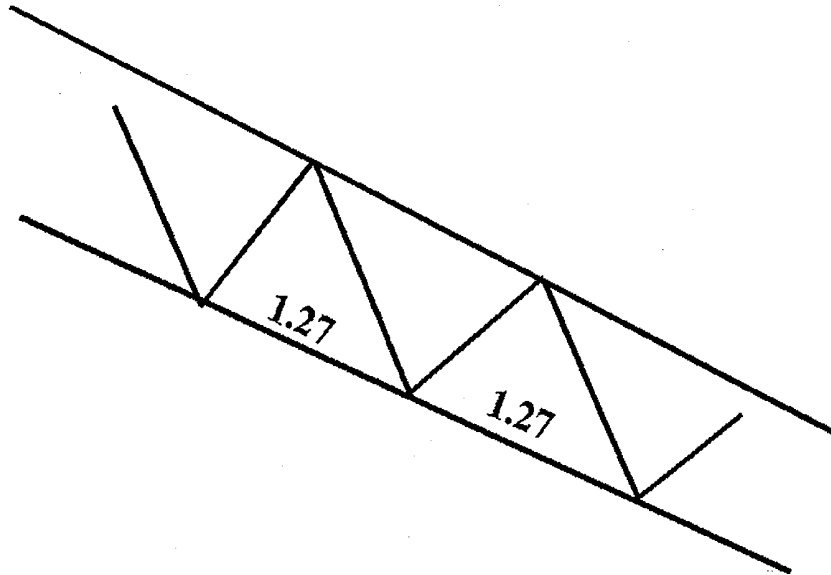

BEARISH CHANNEL: SUPPORT AT 1.27 PROJECTION

If such repetitive price action is identified, a high probability trade set-up exists by buying at the low end of the channel. The channel should be very clear with continual support at each 1.27 projection. The next example will demonstrate the set-up.

The following chart of Gateway Computer illustrates the bearish channel. The stock formed a clear down trend that bounced off the 1.27 projection of the prior rally several times. Although this is a short-term daily chart, it still illustrates how the 1.27 acts as support in a bearish channel.

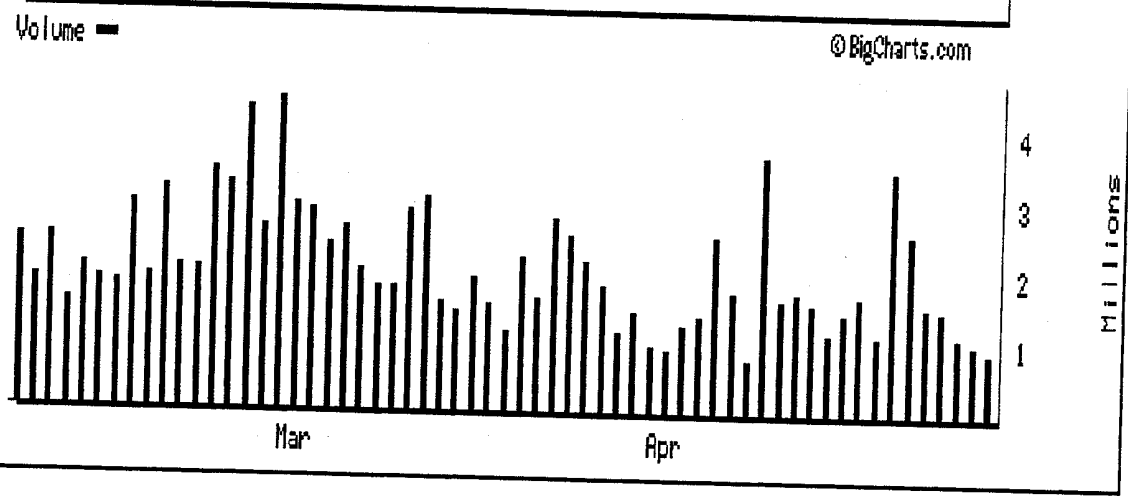
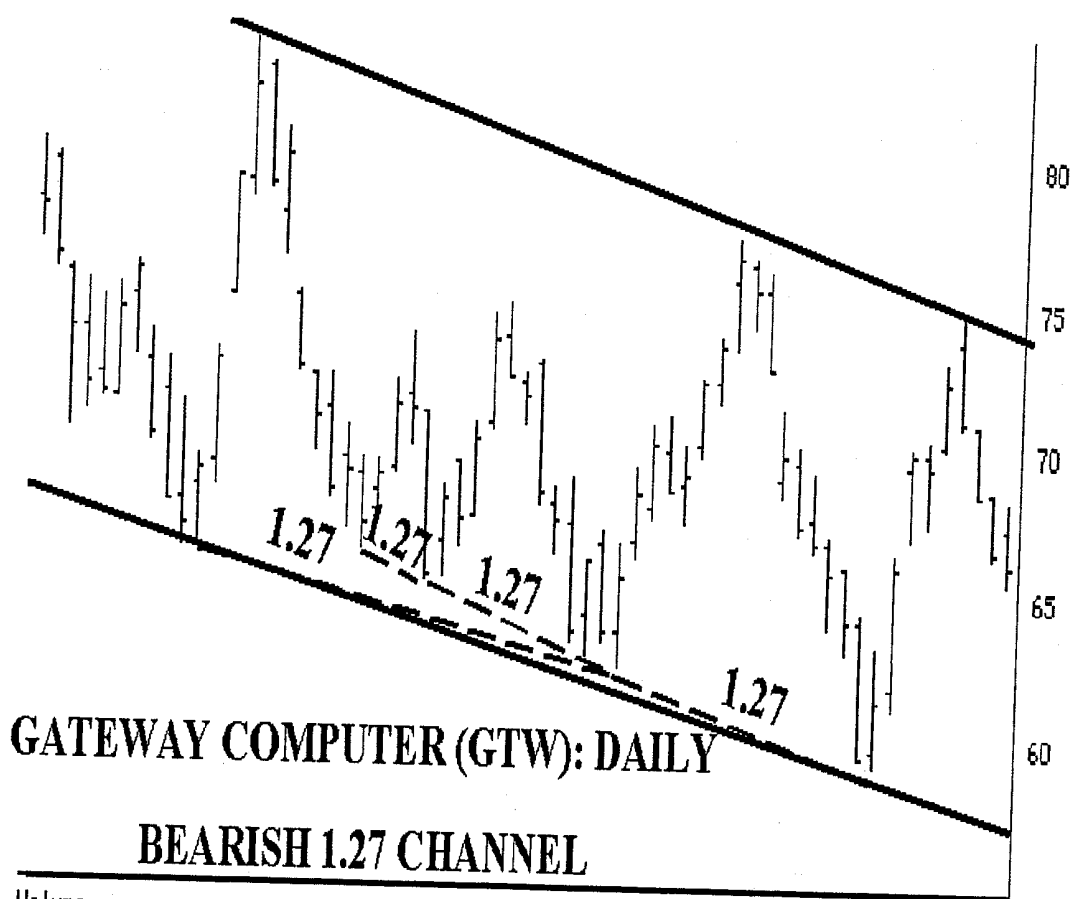

The combination of the lower end of the trend channel and the 1.27 clearly defined this stock's price action. Gateway Computer sold off consistently in this fashion for several weeks. Such a clear set-up yielded nice bounces each time the stock hit this area. Understanding such price action in the future will help you gauge a stock's trend and identify potential opportunities.

1.27 Projection Summary

The 1.27 is another important Fibonacci number. It can frequently gauge price action, when a stock has moved into new territory. After a stock has rallied above a previous high, it is the first place to look for potential resistance. If a stock experiences resistance at the 1.27, it possibly indicates that the price move is not as strong as it might seem. So, it can be a good area to take profits. When a stock declines past a significant low, the 1.27 is the first place to look for potential support. Reversals off the bullish 1.27 projection can often yield nice bounces. Therefore, the 1.27 is a very effective number to determine the strength of a stock's overall trend.

10

1.618 Projection

The 1.618 projection is another significant Fibonacci number, because it usually indicates exhaustive price action. Often, when a stock exceeds the 1.618, it represents extreme price action that is difficult to sustain. In fact, I utilize a general rule about the 1.618 that defines the state of the price action. If a stock has rallied above a 1.618 projection from a previous decline, I consider it overbought. If a stock declines past a 1.618 projection from a prior rally, I consider it oversold. Although a stock can trade past 1.618 projections, these rules have saved me from many flawed executions.

Since the 1.618 represents price action that is too extreme, reversals that occur beyond this area will usually happen quickly. When the 1.618 projection is in a potential reversal zone and it has been exceeded, I know that I am close to executing my trade. As a general rule, I usually wait for a stock to hit 1.618 projection in a potential reversal zone before accepting a trade. Furthermore, the 1.618 is an especially effective measure if other harmonic projections converge in the same area.

Bullish 1.618 Projection

A bullish 1.618 often occurs in an extreme sell-off. When a stock is declining, the price action can often become over-extended. The 1.618 projection point can identify profitable set-ups, since a stock that reverses off this area frequently provides a nice bounce.

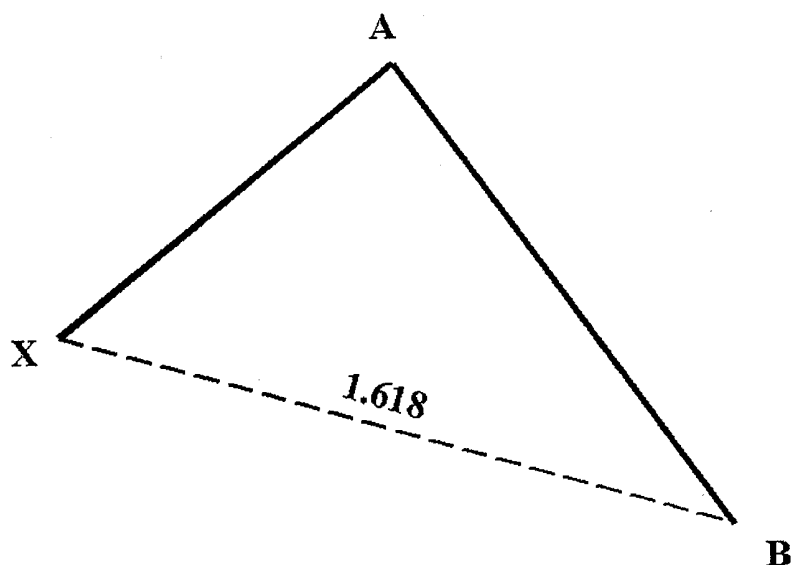

**BULLISH 1.618 PROJECTION
BUY AT B!**

The following daily chart of General Electric illustrates the bullish 1.618 very well. The stock sold off in October 1998 to a low of 69 (pt. B) and then reversed significantly. The 1.618 projection was calculated at 70 11/16. Although it declined slightly past the projection, it clearly found support in this area.

GENERAL ELECTRIC (GE): DAILY

BULLISH 1.618 PROJECTION

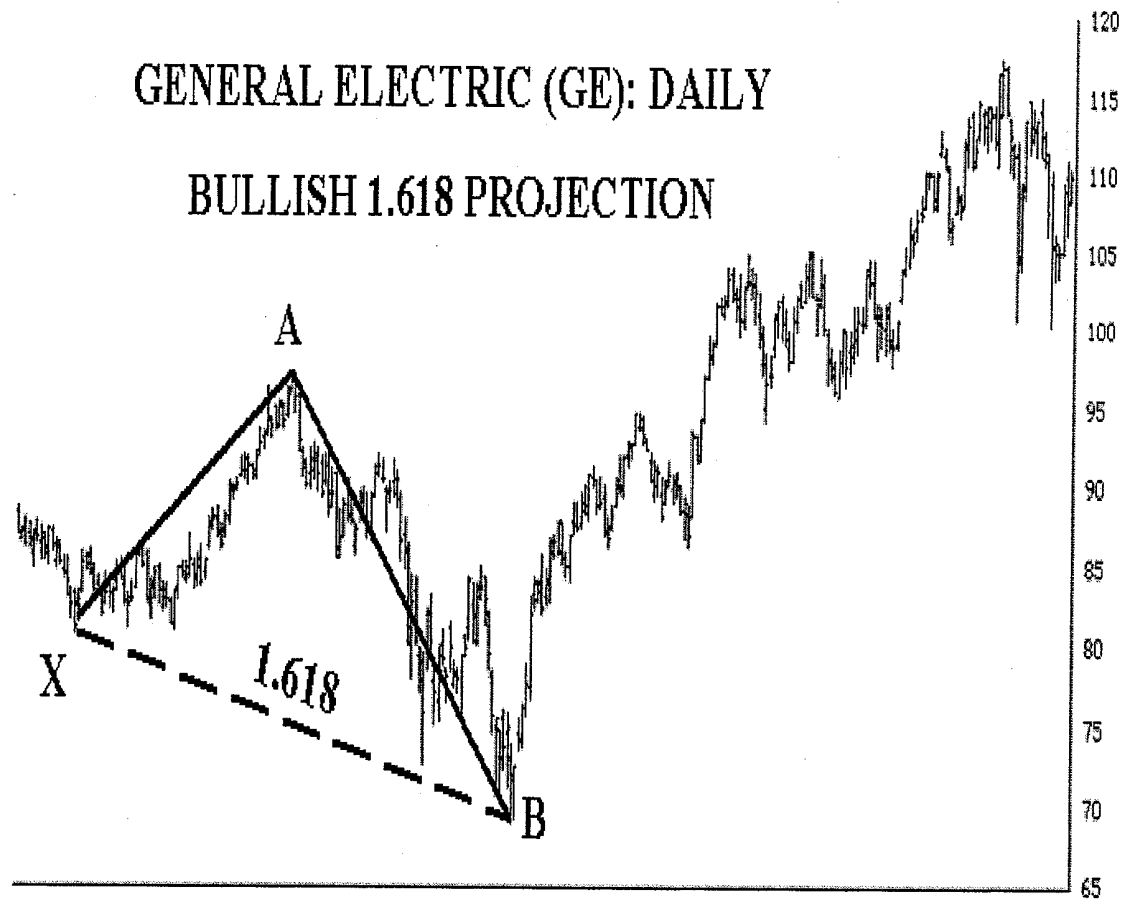

Volume =

©BigCharts.com

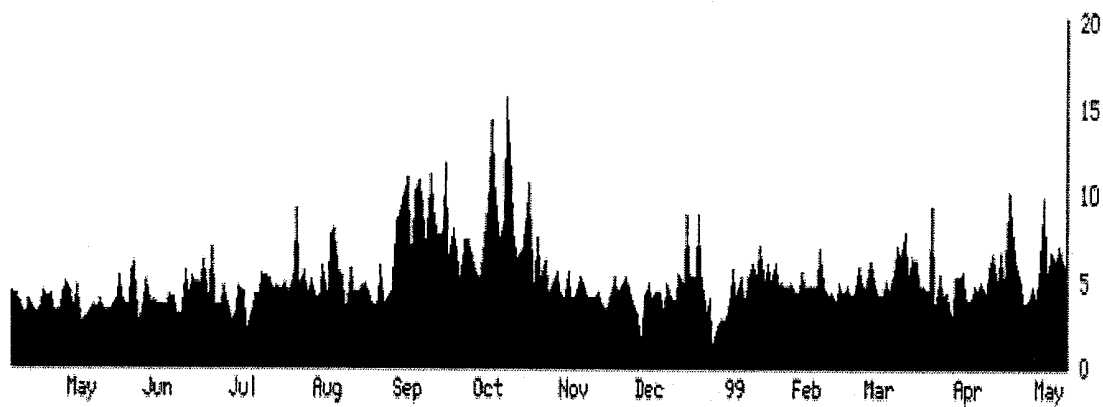

On the next page, I have included an enlarged chart of the price action, which was somewhat strong on the day the stock hit the 1.618. So, you might have waited an extra day for the stock to confirm the reversal. The stock found support in this area. As you can see, within a few days after hitting the projection the stock gapped up and started to rally, which confirmed the reversal.

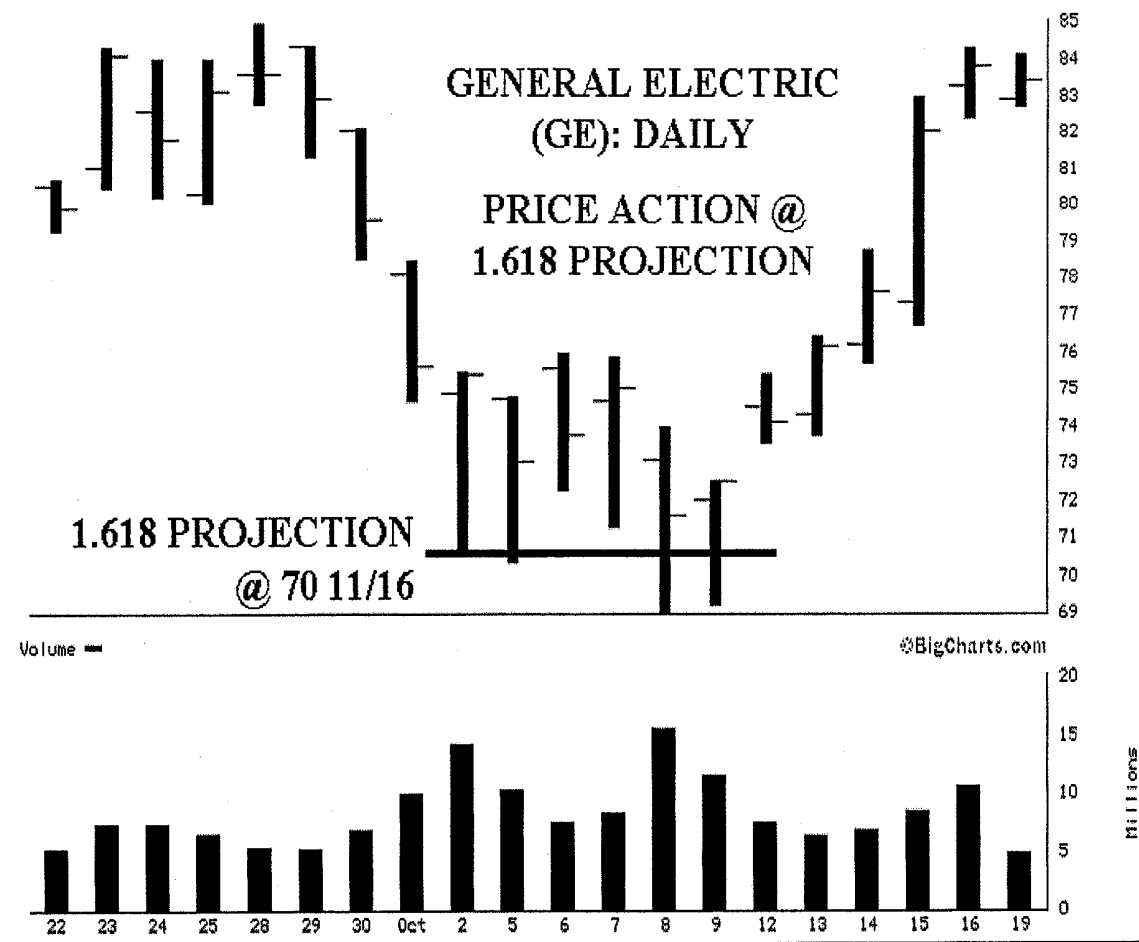

Such bullish price action in the days following the reversal was a good indication of a valid reversal. The stock attempted to sell below the 1.618 projection several times but it was able to stabilize in this area. It is important to note that the stock never closed below the 1.618. Although it tried to sell off past the 1.618 four times, General Electric held firm. Also, after the stock broke out, the price action was very bullish, as it rallied sharply making consistent new highs with positive closes. These signals are substantial evidence of a new uptrend developing.

The next weekly chart of American International Group also illustrates the significance of the 1.618 projection. AIG sold off sharply, losing over 30% of its value over a few months. However, the stock started to reverse the week it hit the 1.618 projection. You might have waited for the reversal to be confirmed, since the stock gapped down the week it hit the 1.618. The reversal was confirmed the following week, as AIG gapped up on the open, and it rallied sharply. In fact, the stock was up over 15 points.

AMERICAN INTERNATIONAL GROUP
(AIG): WEEKLY

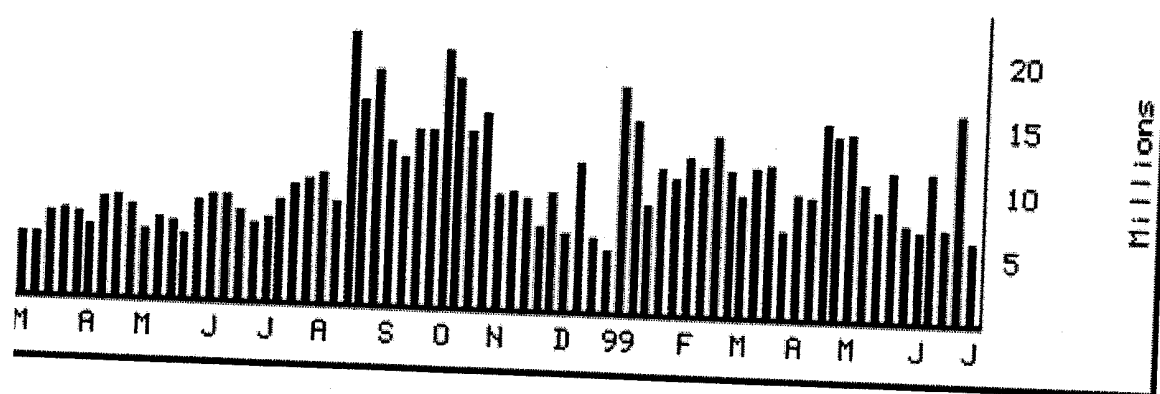
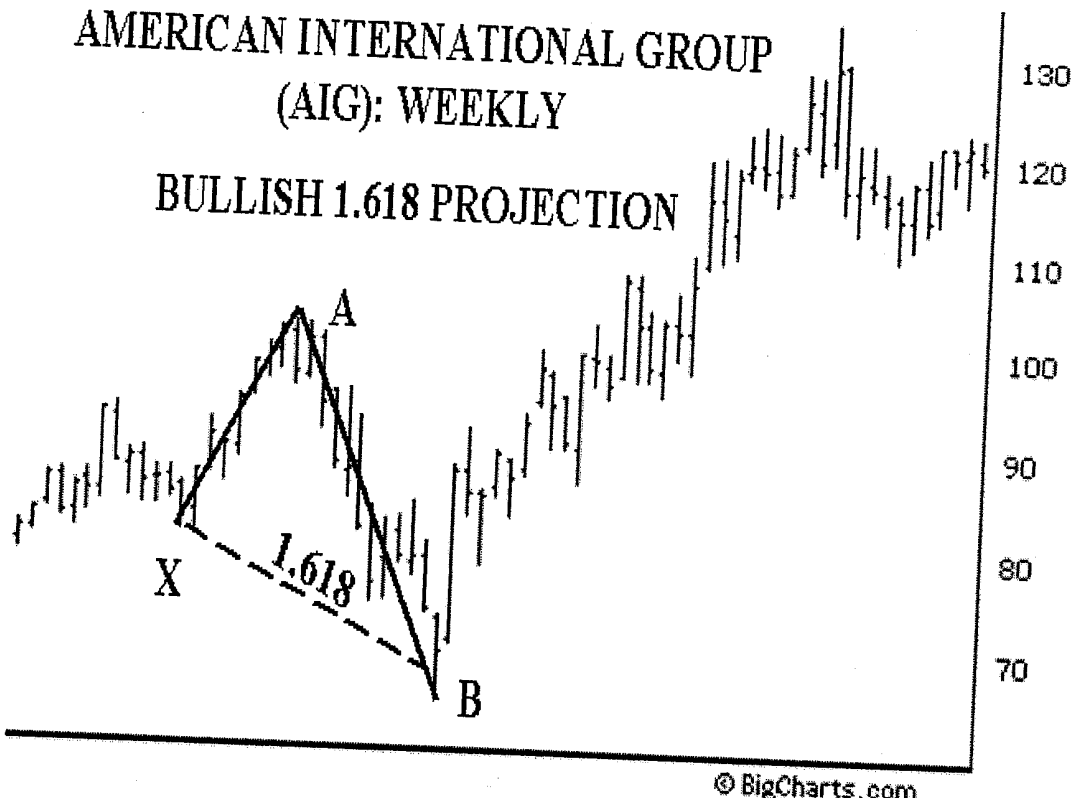

As you can see AIG declined steadily for over three months before reversing off the 1.618. The 1.618 projection was calculated at $68 \frac{1}{16}$. The stock reversed after bottoming at $64 \frac{3}{8}$. Although AIG exceeded the 1.618 by a few points, it was able to finish the week above the projection. In this situation, the stock provided several signs of a valid reversal. The close above the 1.618 and the following week's price action are excellent indications of a new uptrend underway. It is important to recognize these signs after a stock hits a significant Fibonacci number to determine valid reversals.

Bearish 1.618 Projection

The bearish 1.618 is a very important Fibonacci number because it is an excellent area to take profits or enter a short position. As I have stated previously, the 1.618 represents an extreme price area. Often, when a stock hits this projection, it will encounter substantial resistance. If this happens, the rally usually will reverse.

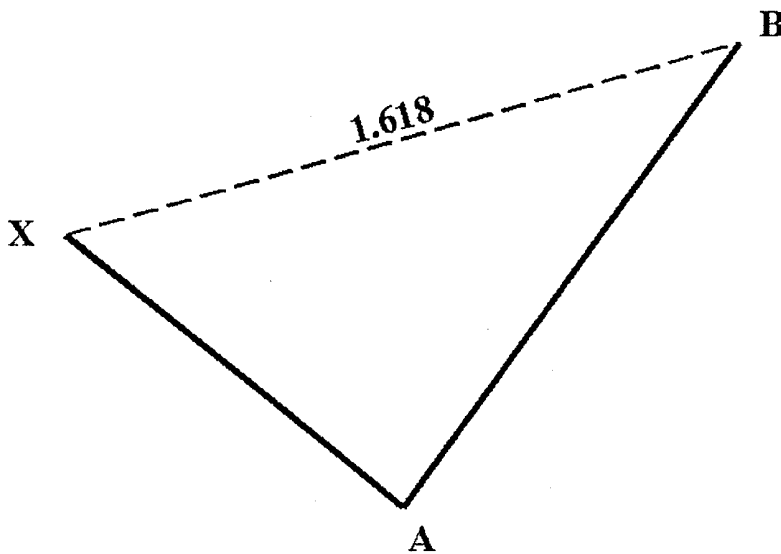

BEARISH 1.618 PROJECTION SELL AT B!

Although stocks do exceed the 1.618 area, it is important to understand that such action can be difficult to maintain. Also, if the area is exceeded, the price action should rally strongly through the area to ensure that a reversal will not occur. Therefore, it is critical to examine a stock closely in this area and be prepared to sell. The following examples will demonstrate the bearish 1.618 well. It is important to study how these stocks had difficulty breaking above the projection area. These examples will help you understand the importance of the 1.618 and will help you properly gauge other stocks that reverse off this area. Let's look at the examples.

The following weekly chart of Medtronic shows how the price action reversed significantly off the 1.618 projection from the prior sell-off. The most important aspect of this chart is the lack of a continuing rally above the 1.618. Although the stock exceeded the 1.618 slightly, Medtronic could not convincingly move above the projection.

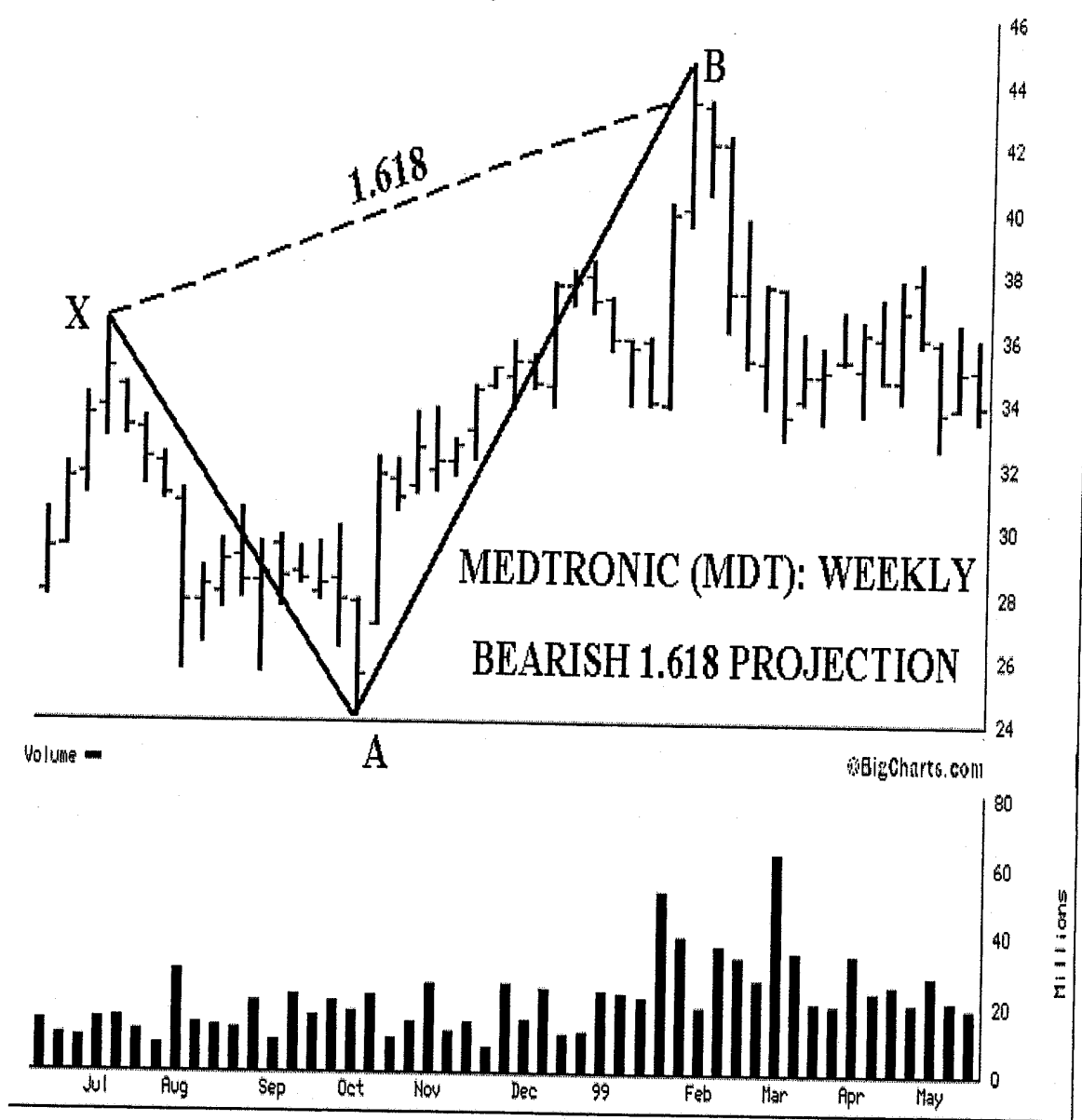

The 1.618 projection was calculated at $43 \frac{1}{16}$. Initially, the stock seemed to be rallying strongly through this area. However, within a few days after hitting the 1.618, the stock stalled, failing to move higher. The stock reversed at $44 \frac{5}{8}$, which occurred on the week it hit the projection.

This enlarged daily chart clearly shows the resistance Medtronic faced at the 1.618 projection. This is an excellent chart to study because of the price action at the 1.618. Since Medtronic was rallying sharply as it approached the projection, you might have thought that the stock was not going to encounter any resistance in this area. However, the stock "hit a wall" at the 1.618, and started to break down.

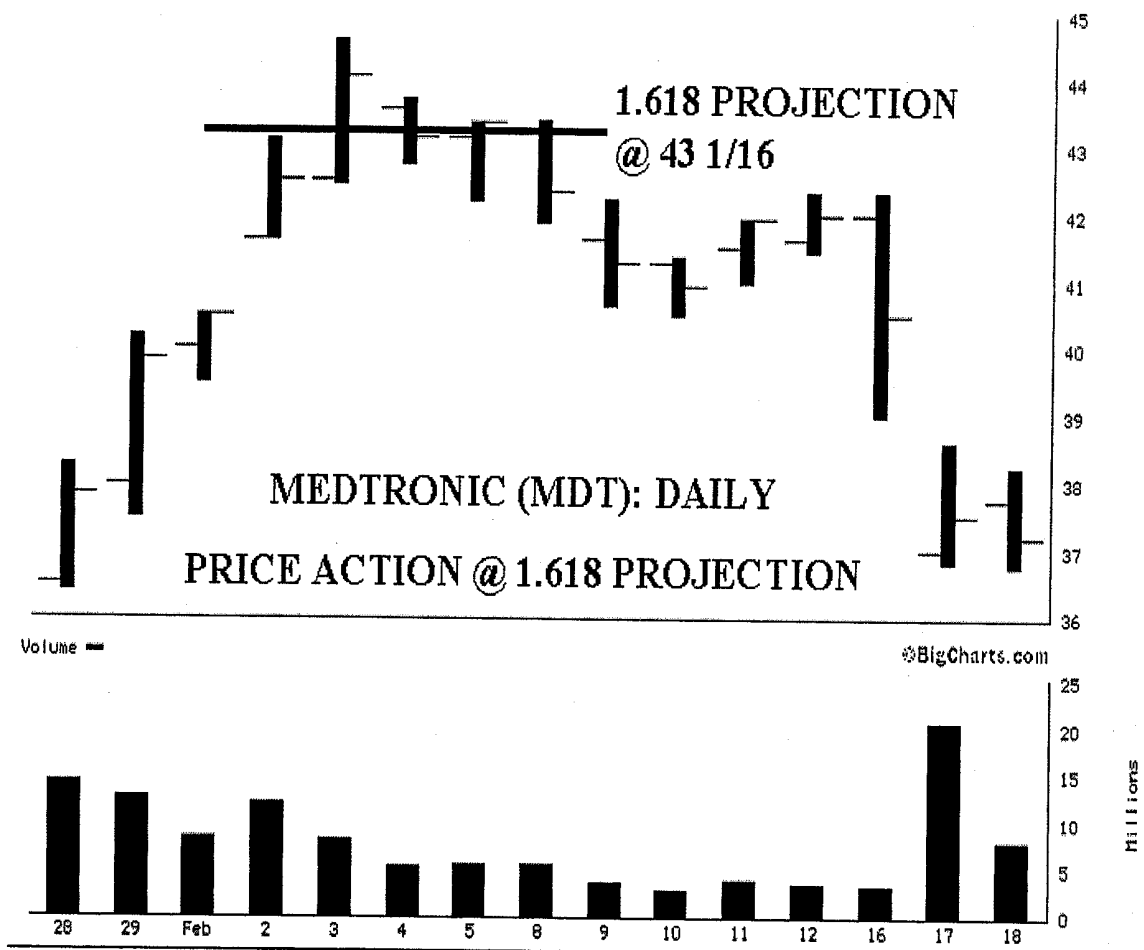

When a situation like this develops, it is important to respect what the price action is indicating. The stock had extreme difficulty rallying above the 1.618. This is especially significant since the stock had rallied sharply in the few weeks prior to the reversal. In fact, Medtronic was up nearly 10 points during the two weeks prior to the reversal. If the stock was going to rally well above the 1.618, it should have continued this strong rally. But, after it hit the 1.618, Medtronic could not move higher and started to sell off. Within a week after hitting this area the stock gapped down sharply and started to make new lows.

Such resistance at a major Fibonacci number is a clear indication of a potential reversal at hand. Even if you did not sell on the day the stock hit this projection, the following several days indicated that this stock was experience strong resistance. The stock started to sell-off and led to a reversal that resulted in a 30% decline within a few months.

The next example of Oracle also illustrates resistance at a major 1.618 projection. Oracle rallied slightly past the 1.618 projection of its prior decline but the stock had difficulty moving higher. The 1.618 was projected to complete at 37 9/16. The stock hit 41 3/16 and it sold off dramatically.

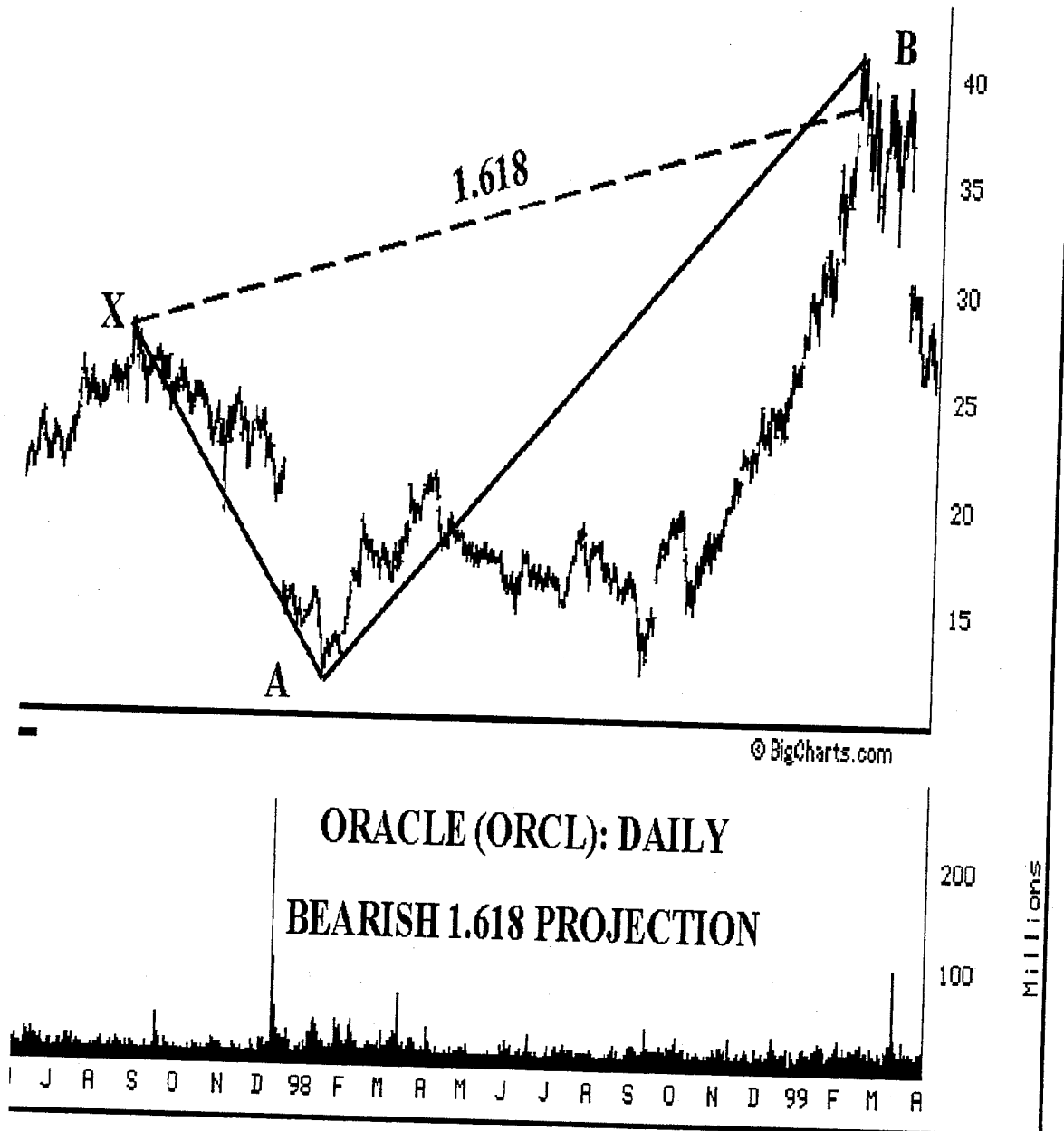

This next chart shows the price action at the 1.618. As you can see, the stock topped in this area. An interesting aspect of this reversal was that the stock gapped up on the day it hit the projection. However, Oracle could not follow through on the upside and within a few days, the stock started to sell off.

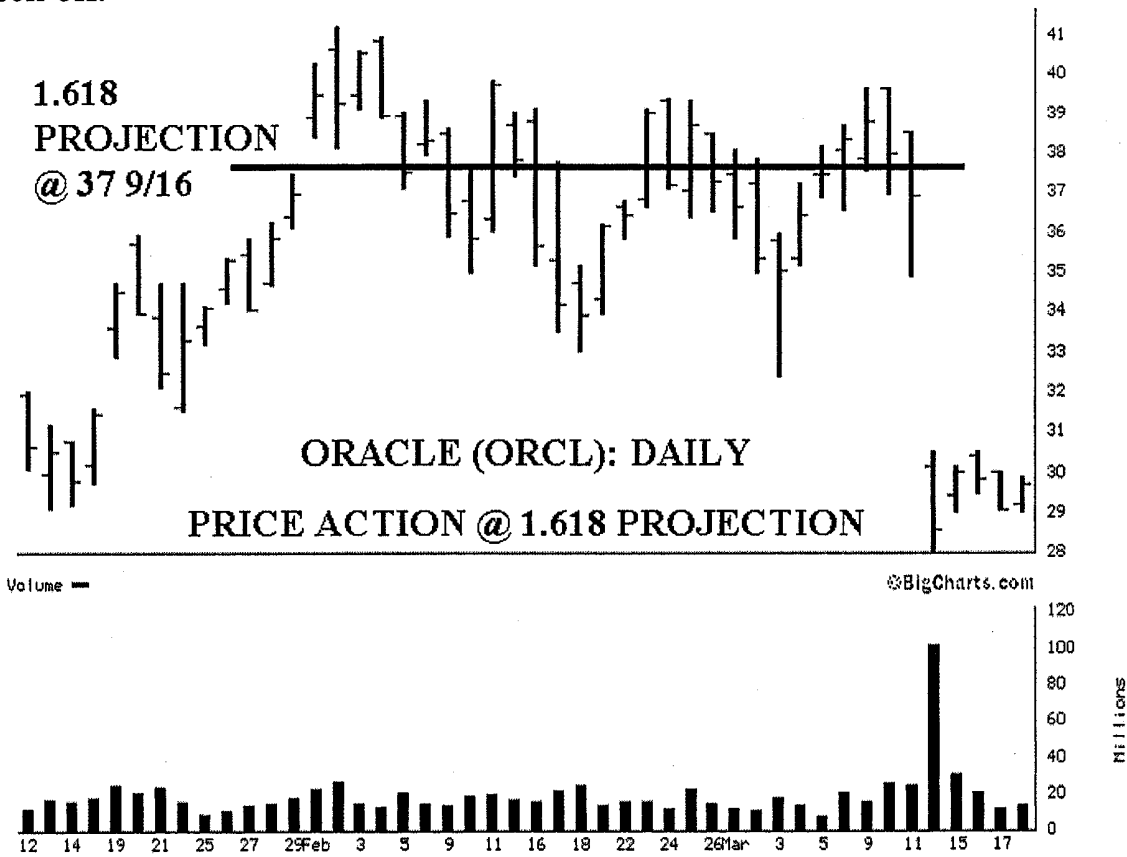

It is important to recognize the significance of this price action at the Fibonacci projection. This stock clearly was topping out at the 1.618. The price action at the 1.618 quickly turned bearish, and a new downtrend was in place.

It is important to remember that when the 1.618 is exceeded, the price action is in an extreme state. In this case, Oracle was over-bought and it was clearly having difficulty breaking above this level. If you were long and you observed this type of action above the 1.618, you must think sell! Take your profits and be happy! If you were lucky enough to participate in this rally, you have to take profits at some point. It is important to let the numbers gauge the price action and indicate when to take profits. In this instance, the 1.618 accurately gauged the exhaustive nature of this rally and clearly was proving to be a good point to get short or cover a long position.

1.618 Projection Summary

The 1.618 is a very peculiar Fibonacci number because of the extreme that it represents. When I see a stock in a 1.618 price move, I must be thinking that it is in an extreme price area that could potentially reverse very soon. Personally, my general rule about the 1.618 is: if a stock has rallied above a 1.618 projection from a considerable prior decline, it is overbought; if a stock has sold off past a 1.618 projection on the downside, it is oversold. By thinking in these terms, I have trained myself to automatically respond to these situations. I prepare myself to buy below a 1.618 projection and I prepare myself to sell above a 1.618 projection. Even if I hear an incredible amount of information in the media that suggests otherwise, I execute my trades when these 1.618 conditions exist.

It takes some time to truly be able to think in these terms and execute your trades according to these rules, especially when the media feeds you information that is contrary to what the projection is indicating. It will probably require several actual experiences of seeing how the 1.618 projections accurately gauge the price action. After you personally witness such situations, you will trust what the Fibonacci projection is saying more than any news item.

Primary Fibonacci Numbers' Summary

As the chart examples demonstrated, the primary numbers, 0.618, 0.786, 1.27 and 1.618, are crucial in gauging market action. These specific areas can indicate a great deal regarding the price action of a stock. Also, they can serve to identify potential trading opportunities within a market that leads you to believe otherwise.

I urge that you master the primary numbers. It takes practical experience to develop "a feel for the numbers." Once you have witnessed some real market examples of "the numbers in action," it will become easier to identify which numbers are the most significant, and you will improve your trade executions.

11

The Secondary Numbers

There are several other numbers that are related to the Fibonacci sequence, which I consider to possess “harmonic” qualities. Although there are many numbers that can be derived from the Fibonacci sequence, which are used for stock chart analysis, I do not incorporate all of them. I believe that the ones that I list are the most important to define valid harmonic set-ups.

0.382, 0.50, 1.00, 2.0, 2.24, 2.618, 3.14

It is important to emphasize that these numbers should serve to complement the potential reversal zone that possess other primary Fibonacci numbers and clear geometric patterns. They are effective numbers in gauging price action, although they are not as vital as the primary numbers.

The most important aspect of these numbers is to be aware of their existence. I will show you several illustrations and examples of simple projections that will help you to train your eye to identify these numbers in the same manner as the primary numbers. In the next section, there will be several examples of the secondary numbers that demonstrates their effective use, especially in complex patterns.

Although these numbers are important in determining harmonic set-ups, I suggest just a basic review of this section. You can skim through the illustrations and chart examples to familiarize yourself with these numbers.

The Extreme Numbers: 2.24, 2.618, 3.14

These numbers should be utilized when a stock's price action has exceeded the 1.618 projection. When the 1.618 has been "blown out," the price action is usually very volatile. Reversals off these numbers can be quite dramatic, quickly reversing after hitting an extreme projection. When you study these chart examples, it is important to look at the general area where the 1.618 was projected. In each instance, the stock possessed some type of a warning sign that continued in the predominant trend. However, when the stock reversed at an extreme projection, the price action formed significant price bars that indicated that the predominant trend was beginning to change. But, the most important aspect regarding these numbers is that they possess an extreme nature.

Bullish Extreme Numbers

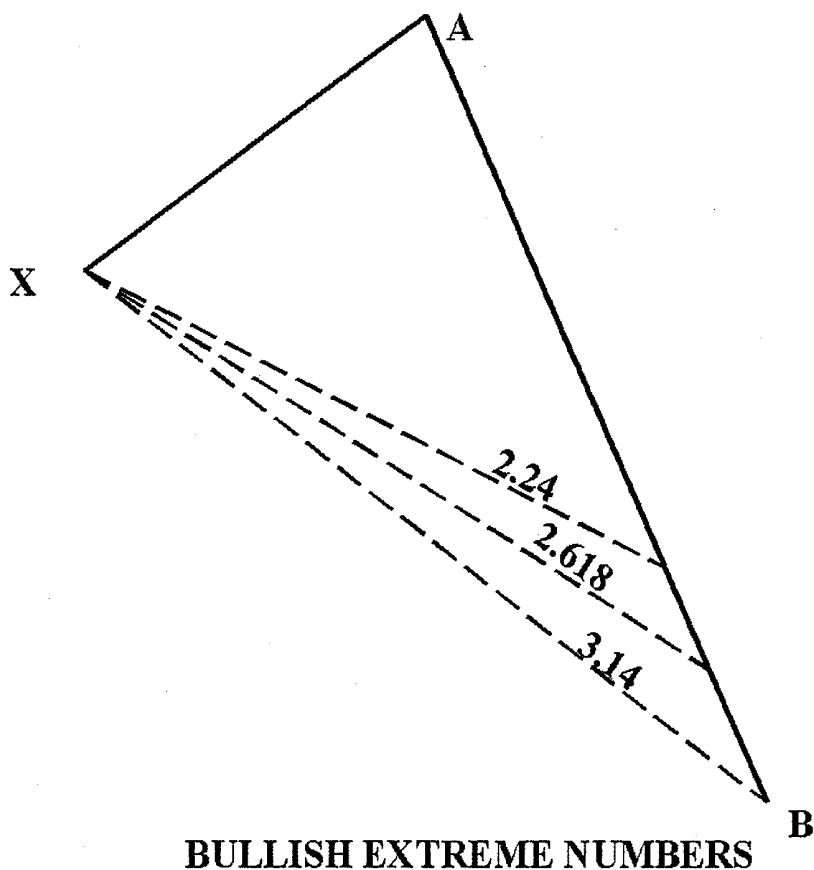

When a stock has declined past a 1.618, the extreme numbers are excellent areas to examine for potential reversal points. The 2.24 is probably the most prevalent of extreme bullish numbers, followed by the 2.618, and in rare situations, the 3.14. In fact, I believe the 3.14 is an ultimate point, where some degree of a reversal usually occurs.

If a stock is going to test these extreme projections, it usually will blowout the 1.618. If a stock declines in this area, the price action will usually be extreme and possess warning signs. However, a reversal off these extreme numbers is usually very sharp and quick.

I have included the following chart examples to demonstrate the extreme numbers. It is important to reference these charts and learn the basic framework of each projection.

**BECTON-DICKENSON
(BDX): DAILY**

BULLISH 2.24

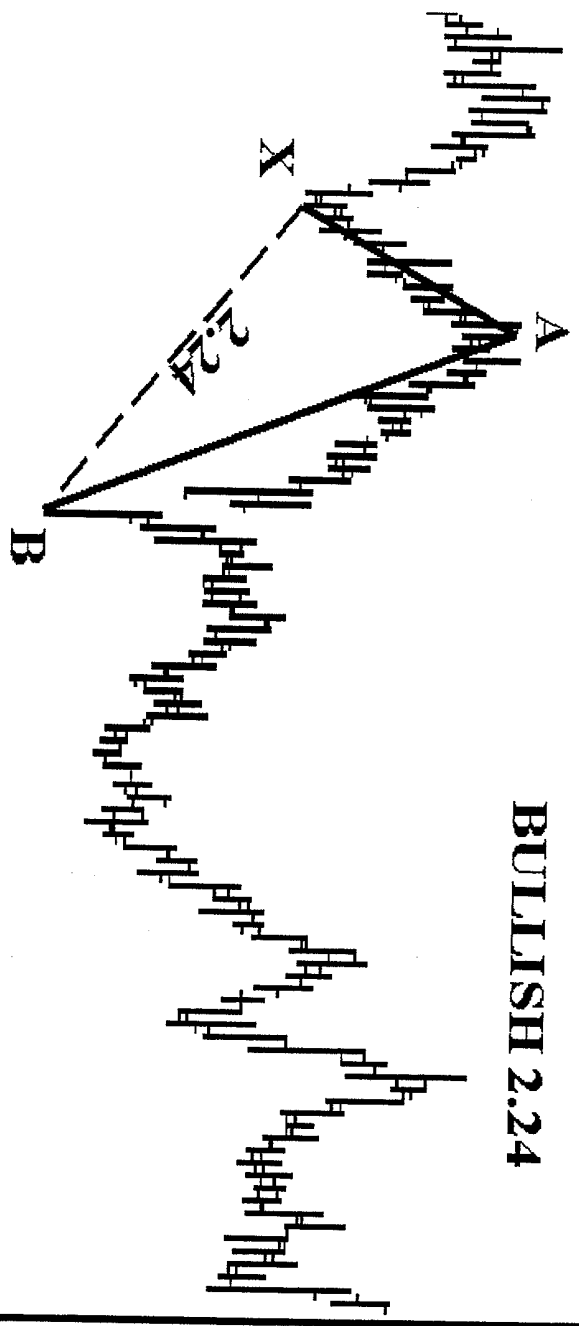

© BigCharts.com

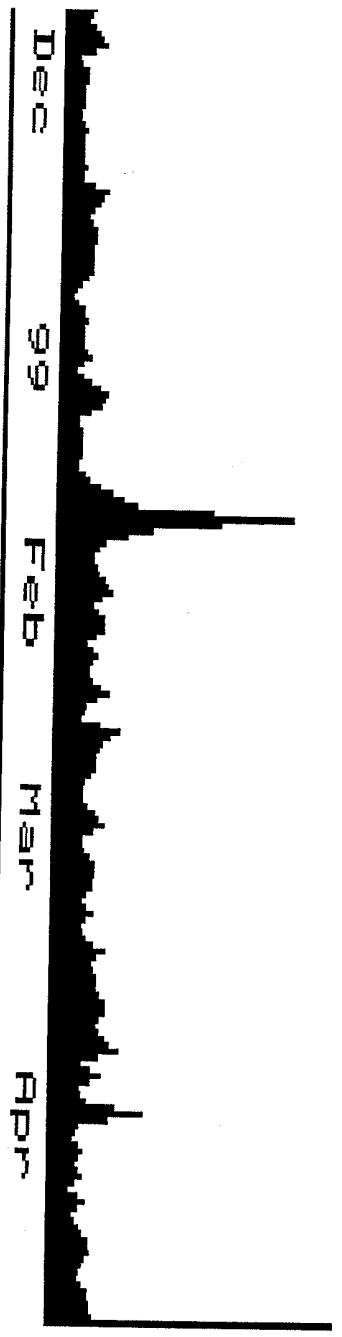

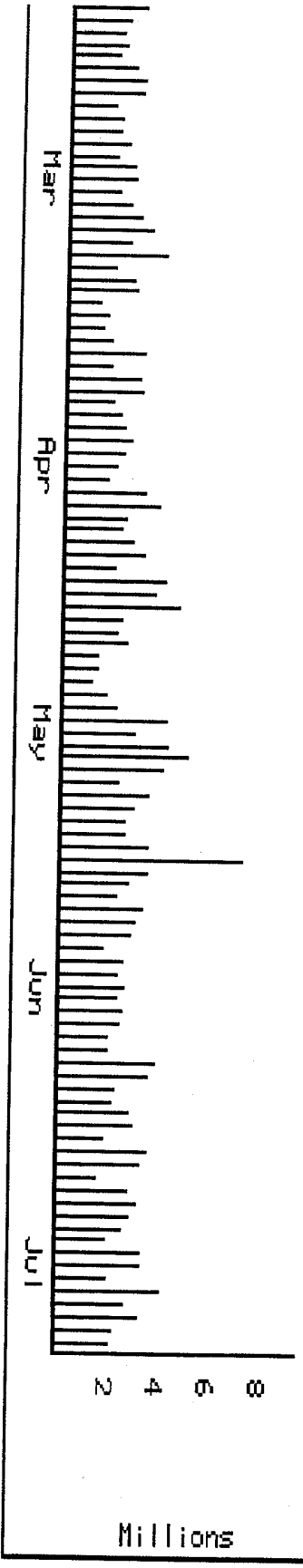
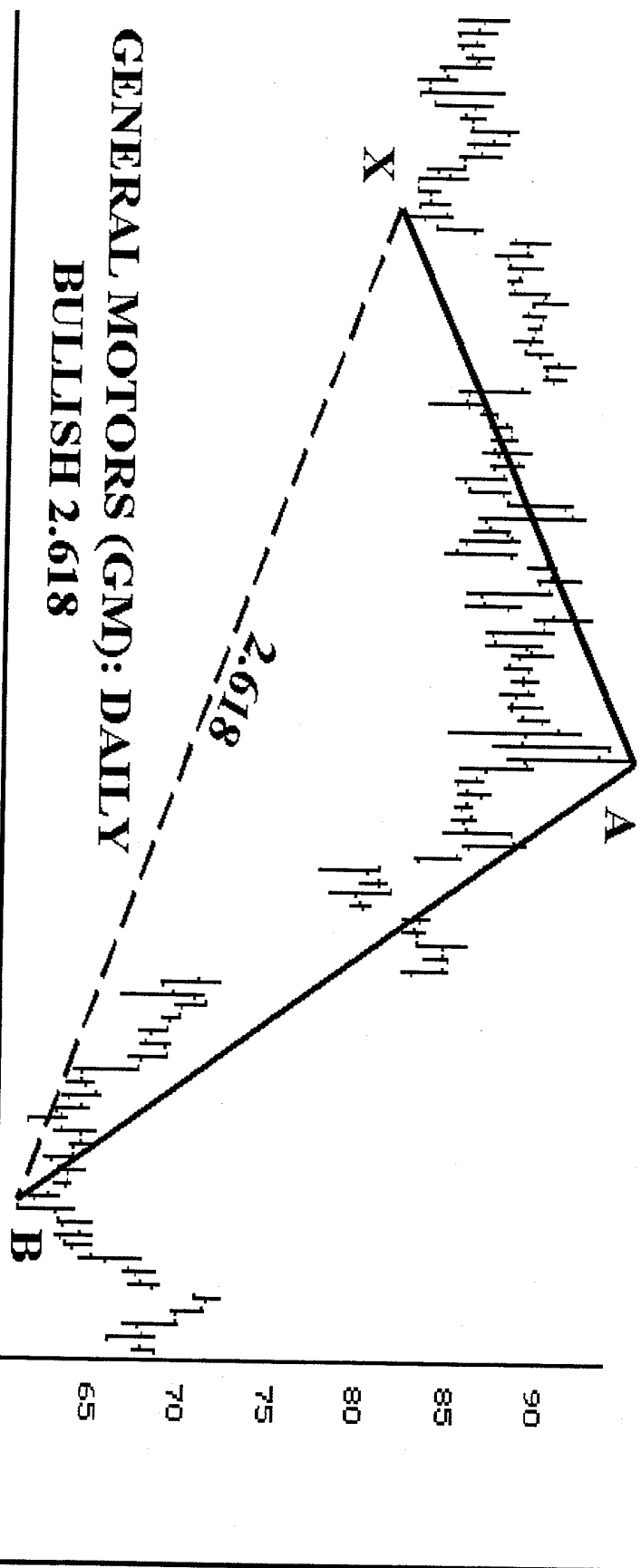

CBS (CBS): DAILY

BULLISH 3.14

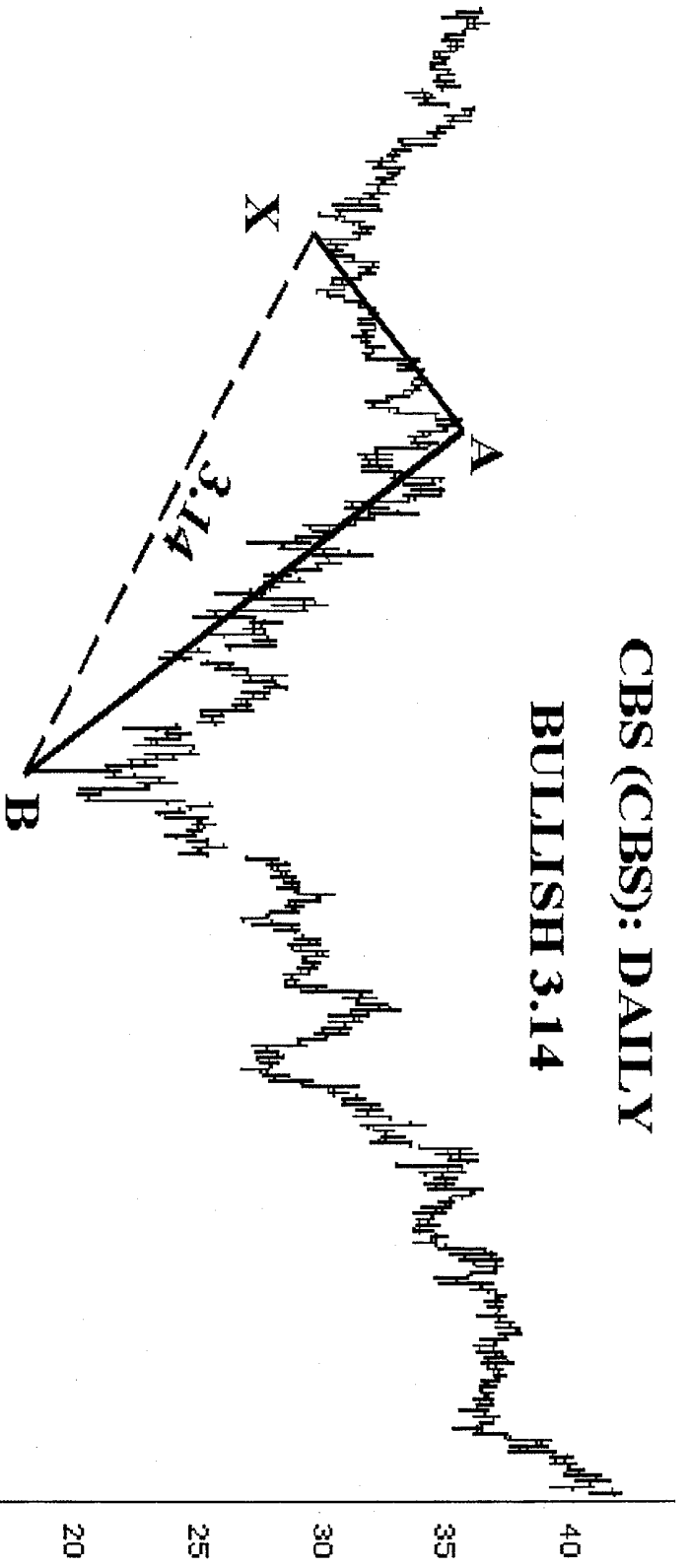

Volume —

© BigCharts.com

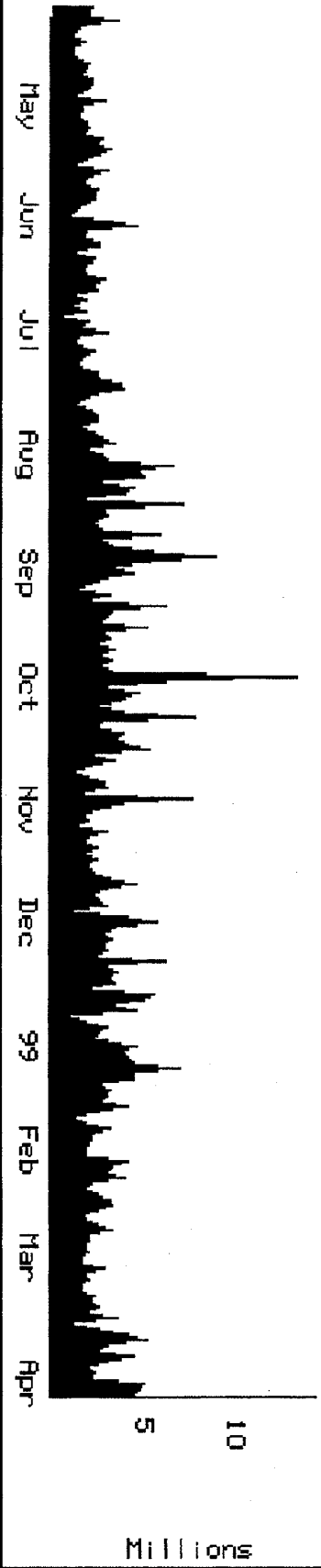

Bearish Extreme Numbers

The bearish extreme numbers are effective when a stock has rallied above the 1.618. It is important to be prepared for extreme price action, when a stock rallies in this area. Reversals can be quite sharp and the price action is usually volatile.

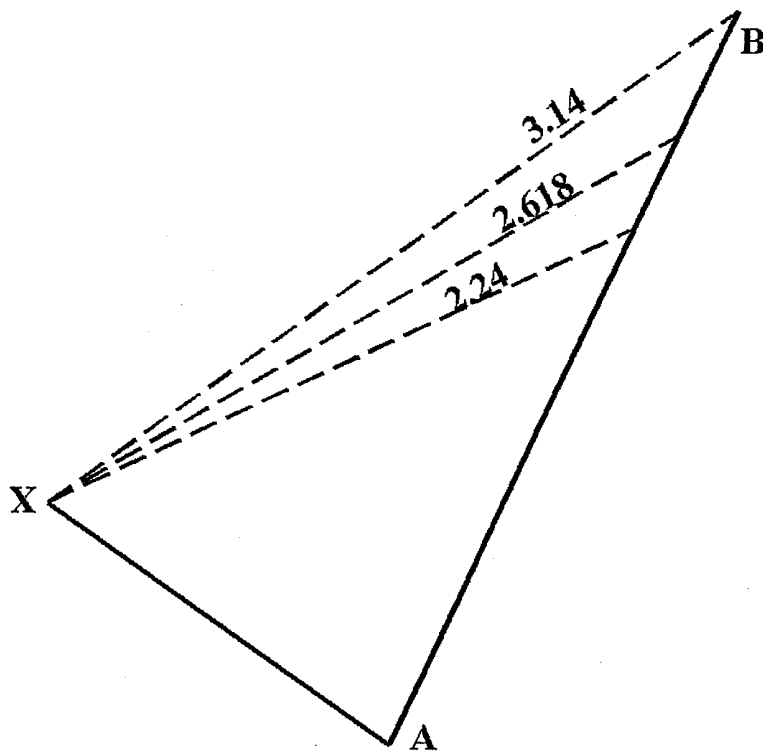

BEARISH EXTREME NUMBERS

After the 1.618 has been "blown out," it is important to be aware of the extreme projections, as potential areas for a reversal. The 2.24 is probably the most common point for a reversal. The 2.618 and 3.14 also occur, although not nearly as frequently.

The following examples illustrate these extreme projections. It is important to briefly review the extreme examples, as to familiarize yourself with these projections.

INTUIT (INTU): DAILY

BEARISH 2.24

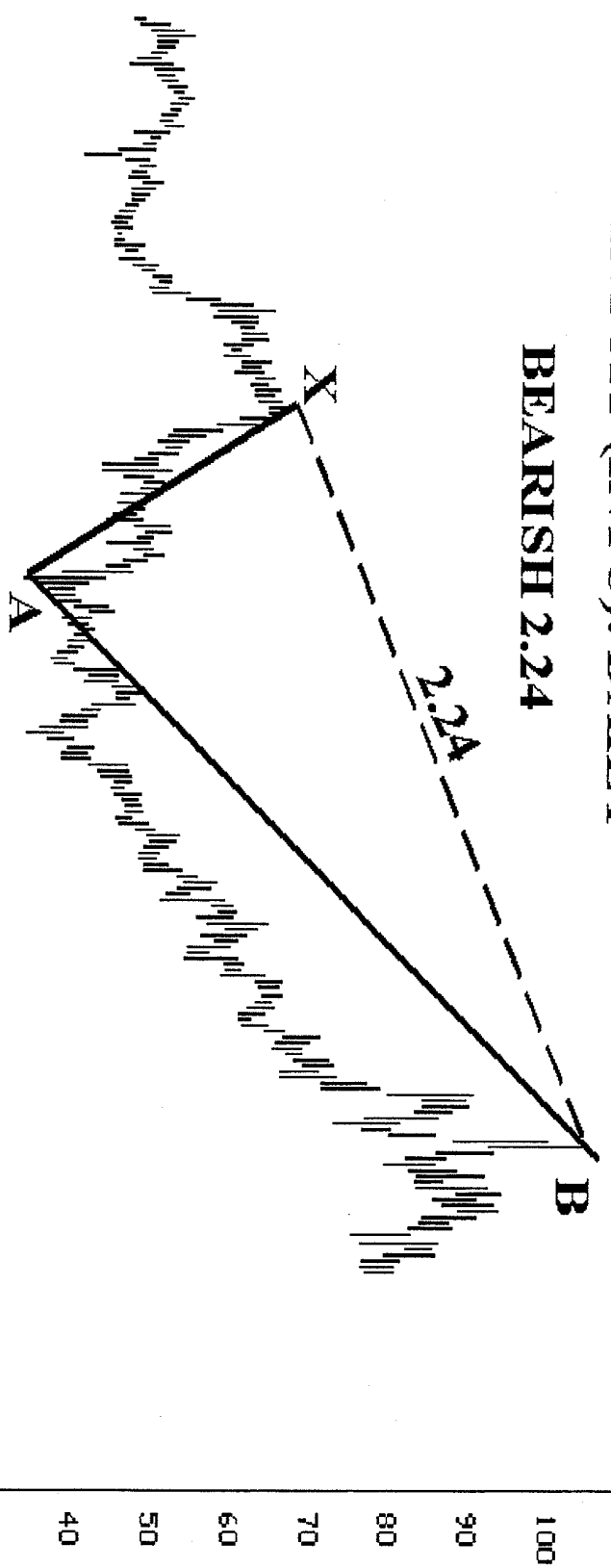

Volume —

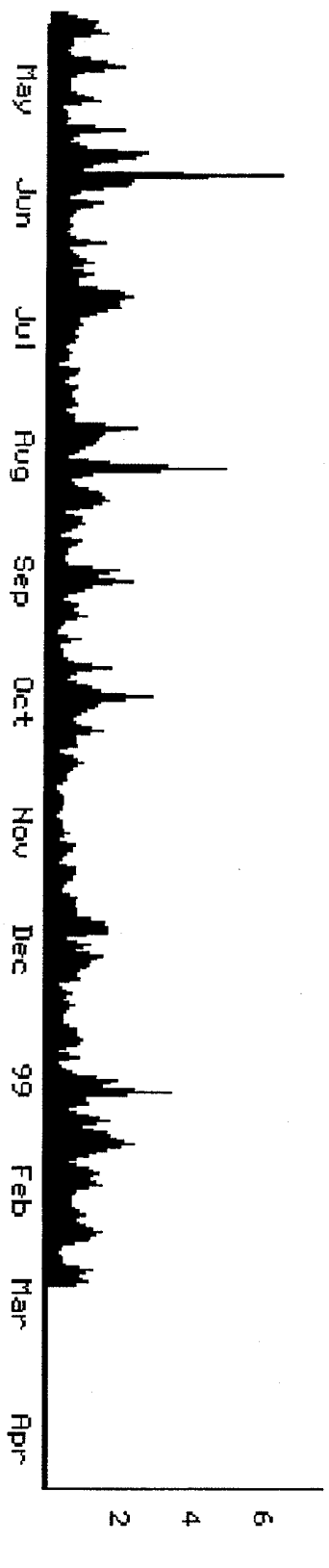

© BigCharts.com

Millions

MICROSOFT (MSFT): DAILY

BEARISH 2.618

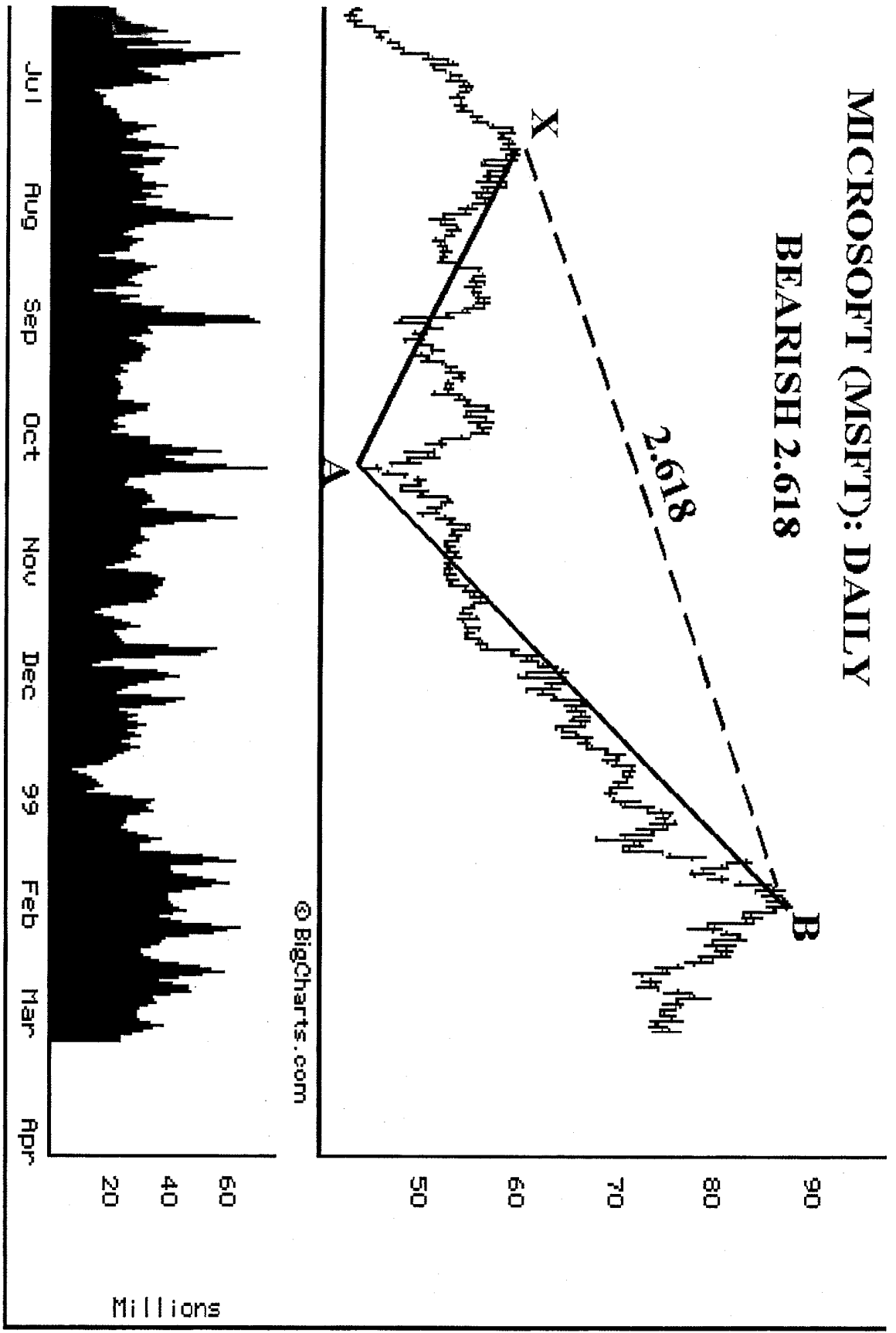

LEGATO (LGTO): WEEKLY

BEARISH 3.14

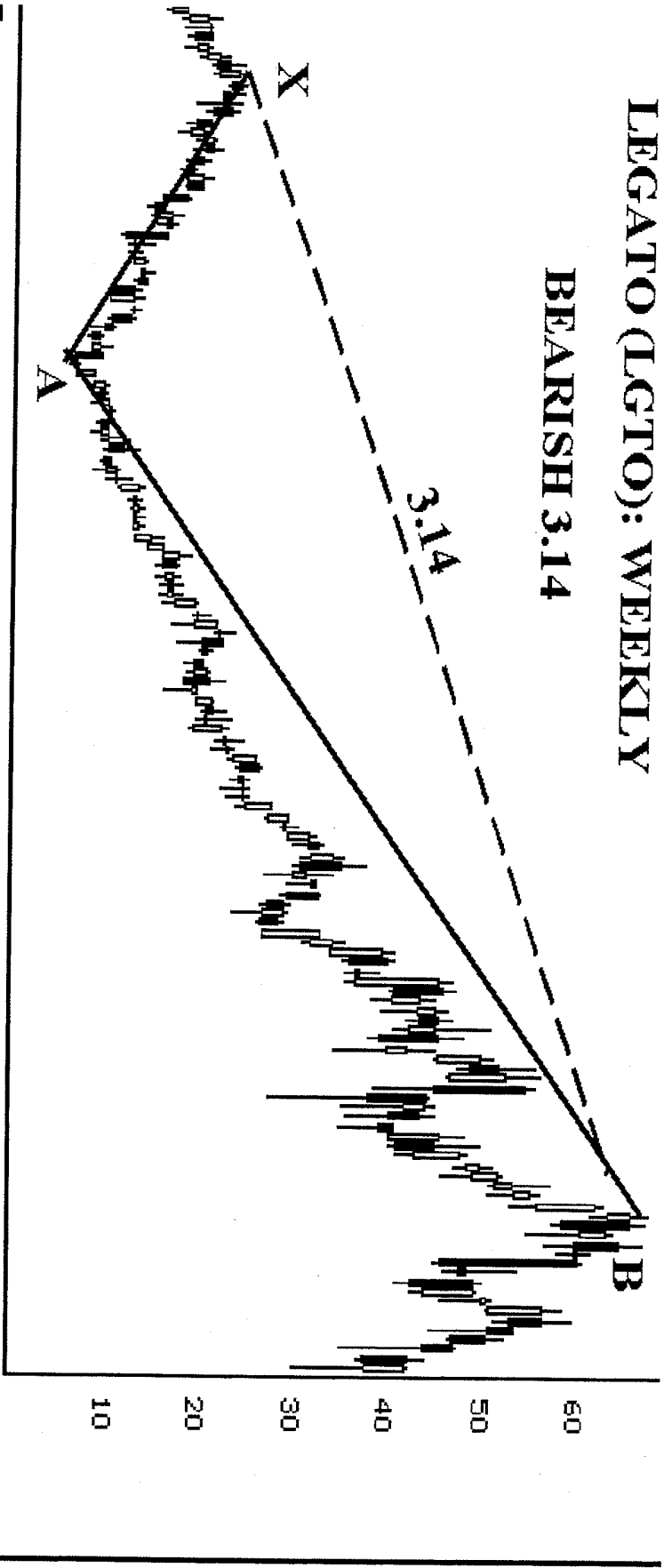

© BigCharts.com

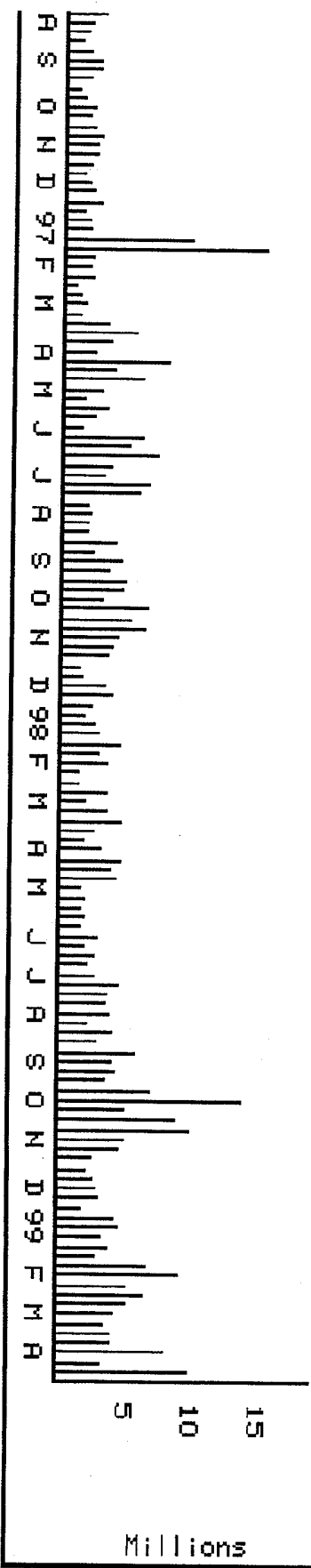

The Sharp Retracement: 0.382

The .382 is mostly associated with a sharp pullback or retracement after a strong move. The .382 retracement occurs when the price action is extreme. The quick and sudden nature of the .382 pullback often leads to another extreme price move in that same direction.

Usually, a .382 retracement of a price move is followed by a 1.618 of that pullback. This means that if the .382 retracement is equal to 1, then the following price move should be at least 1.618. Sometimes, when the price action is very extreme the following price move can be 2.24, 2.618 or 3.14 of that retracement. The most important concept of the .382 is that it is associated with extreme price action.

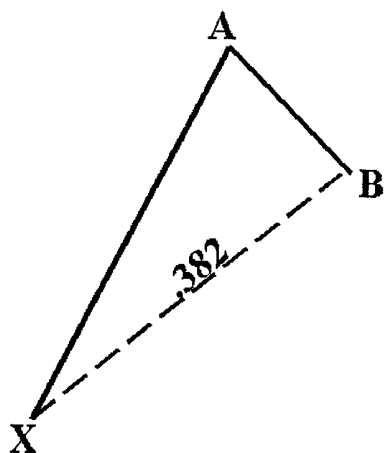

BULLISH

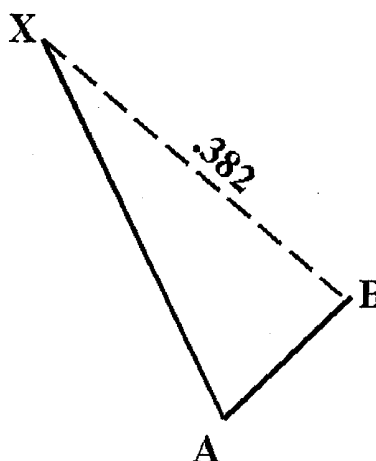

BEARISH

THE SHARP RETRACEMENT: .382

The following examples will illustrate the nature of the .382 retracement. It is important to notice the price action after the reversal off the .382 retracement, as it is usually quite strong.

SCIENTIFIC-ATLANTA (SFA): DAILY

BULLISH .382

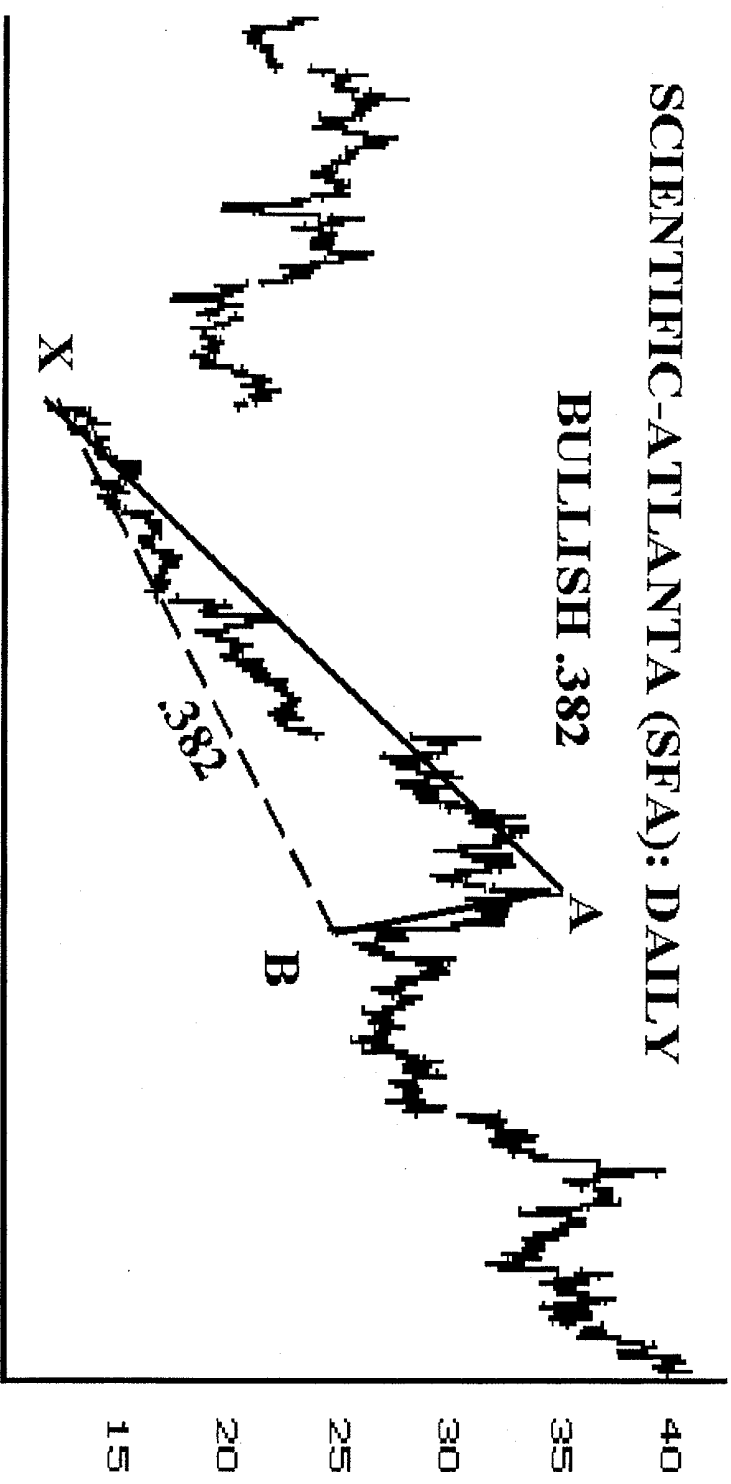

© BigCharts.com

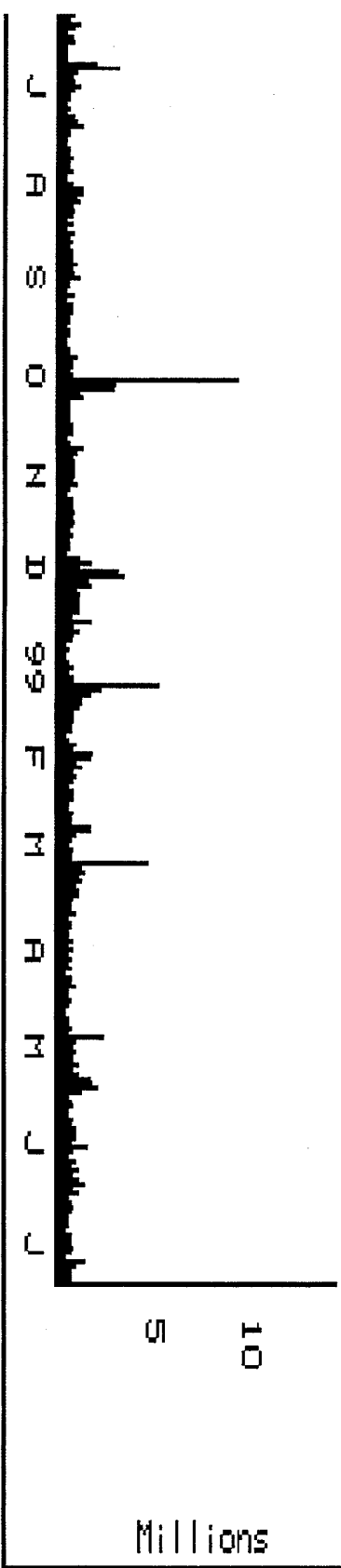

ETOYS (ETYS): DAILY BEARISH .382

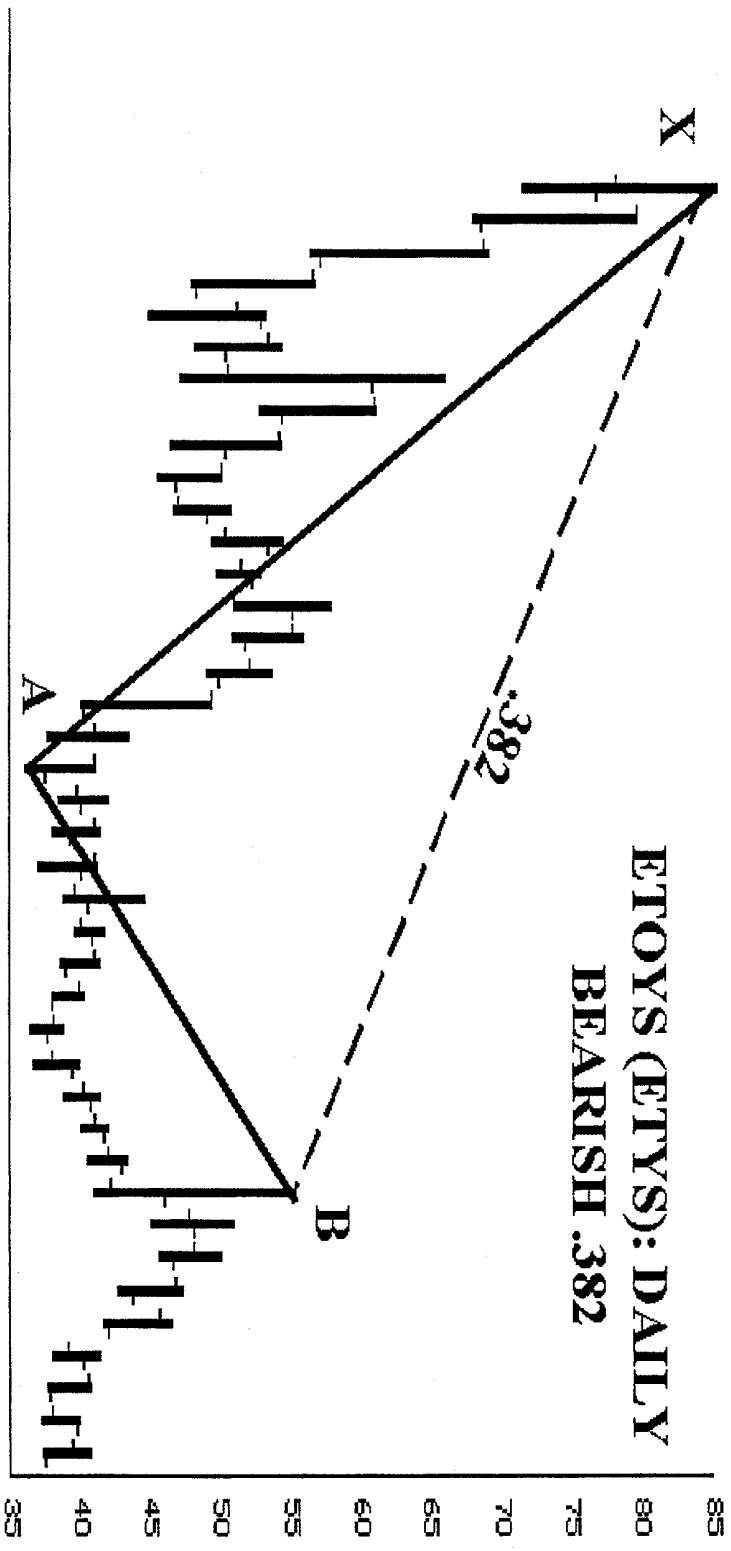

©Bigcharts.com

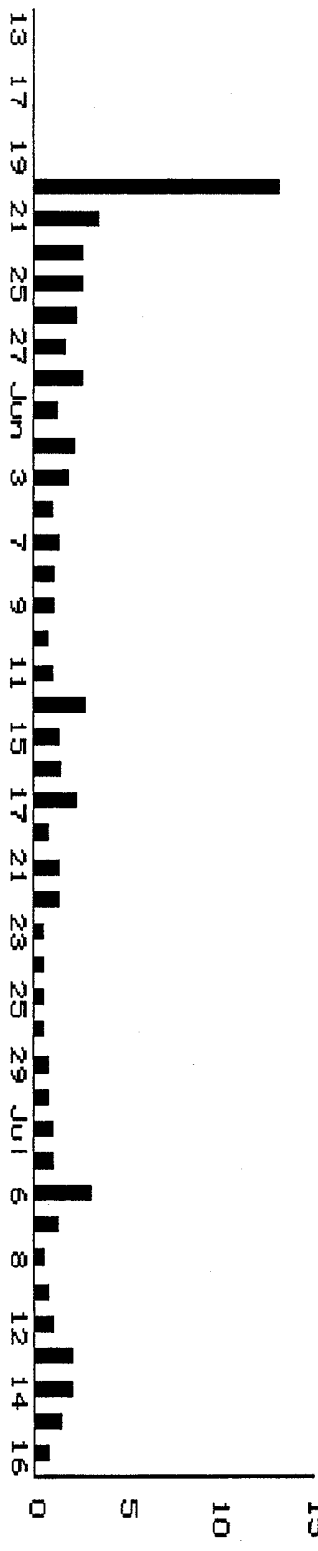

The Static Numbers: 0.5, 1.0, 2.0

I refer to these numbers as static because they are not as directly derived from the Fibonacci sequence as the other secondary numbers. These numbers are frequently found in stock charts. For example, a double top or double bottom pattern possesses two equal price legs. Another common example is the 50% retracement. Often, a stock will retrace half or 0.5 of a price move. But, this price action is easy to decipher. In fact, I believe technicians use these numbers more than the Fibonacci numbers.

I have not included any examples of the static numbers, since the price legs are usually obvious to decipher. Although these numbers can help gauge price action, I do not feel that they are as harmonic as the other numbers. Therefore, I only use them to complement a potential set-up.

Secondary Numbers Summary

The secondary numbers are effective means of gauging market action. However, they should complement other primary numbers, and they are not as significant within a potential reversal zone. So, it is important just to be aware of these Fibonacci numbers, since they can define a harmonic area more clearly.

Part III

Patterns

12

Patterns

Consistently profitable investing can be achieved through the recognition of price patterns. Although it might seem unlikely, stocks do move in harmonic patterns that are very easy to identify. To identify these patterns, you must train your eyes to decipher such price movements.

There are many theories regarding the nature of price action. Many theorists believe that the stock market is random. According to the Random Walk Theory, popularized in the book, The Random Character of Stock Market Prices, by Paul H. Cootner (ed.), published by MIT press, 1964, price action is "serially independent." This means that price history is not a reliable indicator of future price action. Although this theory does have some validity, since anything can happen in the stock market, history has proven that certain patterns do repeat. Therefore, it is important to study historical examples of such patterns for future opportunities.

I suggest that you remove the pattern summary sheet included at the end of this book and post it in a place where you can often review it. You might want to post it next to your computer or the space that is dedicated for your trading. You might even want to make copies of the sheet and post it around your house! I am very serious about mentally reinforcing these patterns because it is essential to train your brain to perceive these set-ups.

Initially, these patterns might be difficult to identify because you probably have never studied a stock chart from this perspective. In a sense,

discovering these patterns is the same as solving a crossword puzzle. The words that are the most familiar will be the easiest to find. But, the more complex words might take some time before they can be found. So, it is important to give yourself some time to decipher these patterns in stock charts. But, the more you study the patterns, the more they will begin to “jump out” at you.

These patterns are the very basic frameworks to help identify potential trade opportunities. The patterns will indicate the general area to examine for a trade set-up. I have observed many stocks that reverse after exactly hitting the completion point of a pattern. However, the most important concept of pattern recognition is to define the specific area where a stock can reverse. If a stock possesses several harmonic calculations that converge within a few points, a reversal is highly probable.

After you develop some experience, you will begin to “trust” the patterns more than any other information. In my experience, when I initially utilized these techniques, I frequently resisted to execute at the numbers. For example, if I was long a stock, I usually held on for a greater profit, even if I knew that a pattern was indicating resistance. However, I quickly learned that such thinking costs money. As I employed these techniques effectively, my trading and understanding of price action improved tremendously.

It is important to view these patterns as reliable signposts of future price action. They will guide you through very confusing markets. Quite often, the patterns will indicate a potential opportunity when the news in the media suggests otherwise. It has been my experience that the patterns are the most reliable indicators of price trends, and they are my fundamental basis for identifying trade opportunities.

13

AB=CD

The most basic pattern is the AB=CD. In this pattern, the A to B leg is the first price move. After a brief retracement from point B to point C, the pattern will complete the C to D leg, which is the same length as AB. Simply, after the AB and BC legs have been established, you project the AB length from point C.

The AB=CD pattern was first described by H.M. Gartley in his book, Profits in the Stock Market, published in 1935. This pattern also has been described as a lightning bolt pattern. But, for these purposes, it will be referred to as the AB=CD. This simple framework is the basis for pattern recognition of stock prices. It is imperative to study price charts that exhibit this basic pattern, as the framework for entry and exit strategies because they accurately indicate profitable trade opportunities.

Although the price action will not always be exactly equivalent, the AB=CD legs usually will be close enough – within a point or two - to determine the reversal points. Sometimes, this pattern will be exact. I usually wait for the CD leg to at least equal the AB leg. Although, it is not uncommon for the CD leg to slightly exceed the length of the AB leg, the most important concept is to study the area where these two price legs are closely equivalent.

The price legs should be generally symmetrical possessing a consistent slope. It is important to study the time duration of each leg. The AB and CD legs should be approximately the same length of time to complete. For example, if the AB leg is ten price bars, the CD leg should require the same length of time. Although this is an ideal situation, the time duration does not need to be exact. If the price legs are close, the pattern is still valid.

I believe that this pattern is most effective because it requires that you "buy low and sell high." I know that such price action might seem oversimplified, but this price pattern occurs frequently. If you train your eye to notice this pattern, it will begin to jump out at you. The most important aspect of this pattern is to look for two price legs that are distinct. Once you study several examples, you will be able to decipher quickly AB=CD patterns in other stock charts.

Bullish AB=CD

In the bullish illustration, point A is the highest point and point D is the lowest. Each price leg should be distinct with a symmetrical slope down.

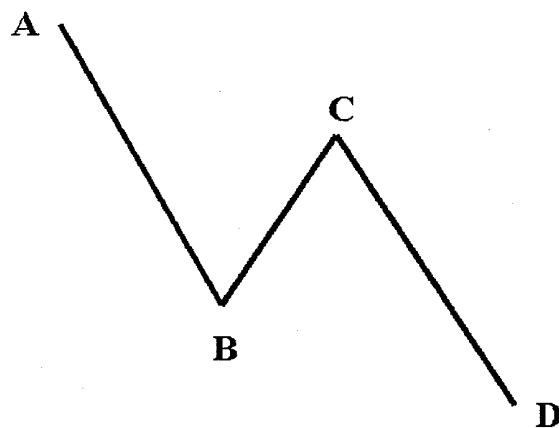

BULLISH AB = CD

BUY AT POINT D!

It is difficult to observe this pattern form on a price chart and believe that a buying opportunity exists. Once the CD leg breaks down past point B, it seems as if the stock is weak. Although it may be difficult to perceive, the pattern is actually indicating an excellent buying opportunity.

I know from my own personal experience that executing my trades according to this pattern was difficult because it required that I buy a stock

when it was selling off. I found myself frequently "fighting" the pattern. I would calculate the completion point of the AB=CD pattern, prepare my trade and not execute at my predetermined price.

Before I employed this pattern in my trading, I waited for a stock to confirm the reversal. I would wait for some type of oscillator or volume indicator to substantiate the price action. This confirmation usually delayed my executions and often did not prove useful at all.

Bullish AB=CD Stop Loss

The stop loss in this pattern is somewhat subjective. Generally, the stop loss should be a point or two below the exact completion of the pattern.

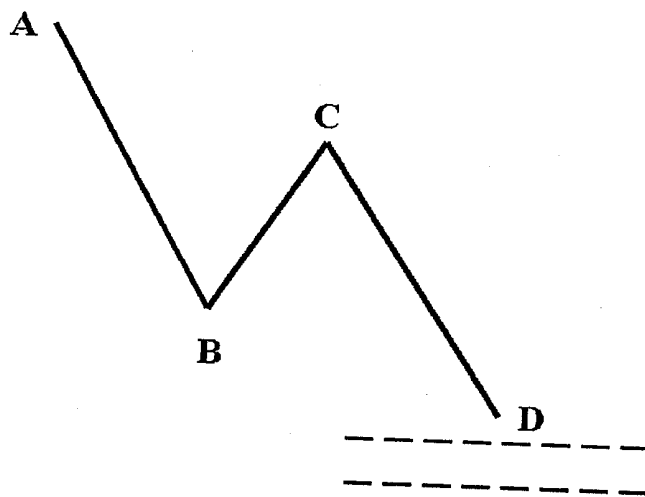

**BULLISH AB = CD
STOP LOSS BELOW POINT D!**

If a reversal is going to occur, the price action usually will turn bullish in this area. So, it is important to study this area closely to determine the validity of the trade.

Once the stock hits the area where the pattern completes, the price action "should" begin to rally. If the stock does not turn around, there are some signs to be aware of that will invalidate the set-up. If the stock closes below the completion point or continues to decline after hitting the area, it

would signal that the reversal probably will not occur. Hence, the stop loss should be executed.

Ideal Bullish AB=CD

The ideal bullish AB=CD pattern will have two distinct declining price legs. The pattern begins at point A with a sell-off to point B. After a retracement to either the .618 or .786 of the AB leg, the CD leg begins. The sell-off of the CD leg should complete at either the 1.27 or the 1.618 projection of the BC leg. Let's look at the illustration.

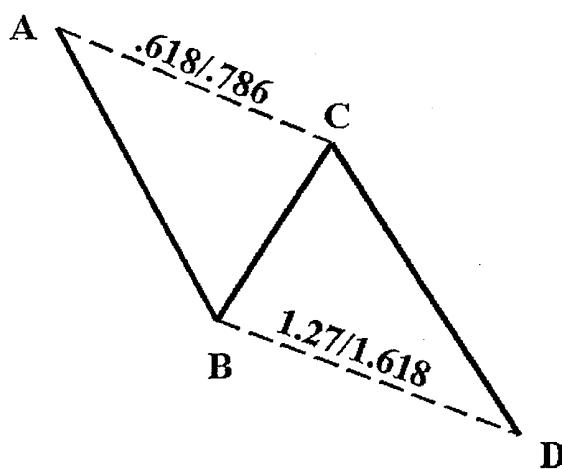

BULLISH AB = CD

BUY AT POINT D!

The completion of this pattern should have two harmonic calculations converging in a specific area. The most important number is the point where the CD leg equals the AB leg. I consider the completion of an exact AB=CD a minimum requirement before entering a trade. Sometimes a stock will reverse just shy - less than a point - of the exact completion point. In these situations, I wait for a clear reversal sign in the price action before executing a trade. The BC projection, either 1.27 or 1.618, should converge

very close to the completion point at D to complement the potential reversal zone.

Although the $AB=CD$ is usually distinct, the Fibonacci calculations can be very effective in determining the completion of the pattern. As a rule of thumb, I examine the retracement of the AB leg to determine the BC leg projection. Specifically, if the BC leg retraces to the .618 of AB, the completion of the pattern should occur at the 1.618. If the BC leg retraces to the .786 of AB, the pattern will complete near the 1.27 BC projection. Without getting into a dissertation on Geometry, it is important to be aware of these relationships.

This pattern occurs very frequently. Often, the ideal pattern will bounce almost exactly off the harmonic numbers and provide a set-up that almost seems too good to be true. Although the pattern can seem too simple at times, it accurately indicates areas that yield significant reversals. Let's look at some examples.

The first example of Costco is a near perfect $AB=CD$ pattern. The stock formed two distinct price legs and reversed almost exactly off the completion point of the pattern.

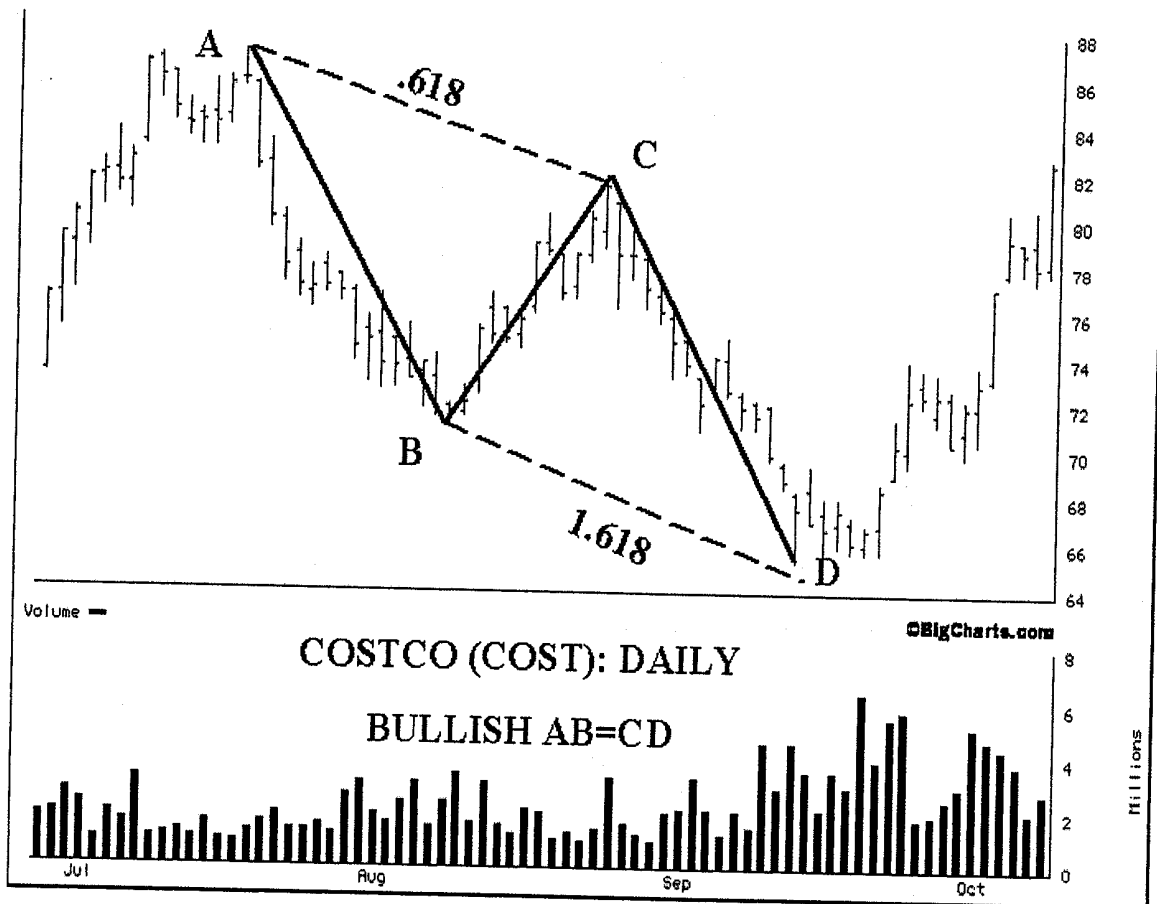

The bullish AB=CD possessed two numbers that were within 1 1/2 points. The pattern was calculated to complete at 65 11/16 and the 1.618 BC projection was calculated at 64 3/8. These two numbers suggested an excellent buying opportunity right around 65. The symmetry of the pattern was almost exact, as the AB leg was 16 days and the CD leg was 15 days. The stock reversed just past the completion of the AB=CD pattern at 65 1/2.

The next example of Compaq sold off and reversed after almost completing an exact AB=CD. This AB=CD pattern yielded quite a reversal, as Compaq more than doubled in the following six months. In addition, Compaq completed an almost exact AB=CD.

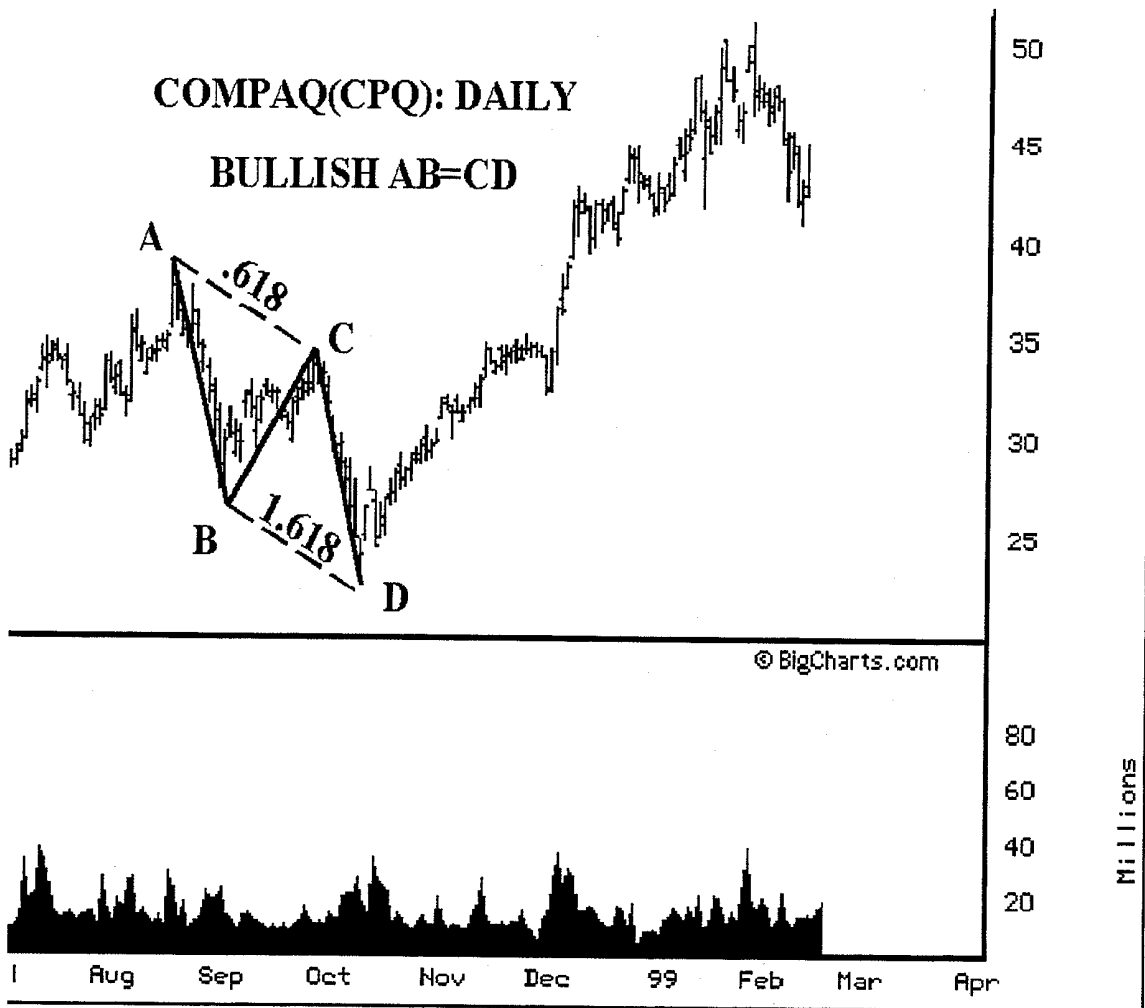

This set-up was quite harmonic because the two calculations converged at almost exactly the same point. The AB=CD completion point was projected at 22 7/16 and the 1.618 of the BC leg was calculated at 22 1/2. When two projections converge in an area this close together, there is a

high probability for a reversal. Another very harmonic aspect of this set-up is that the BC leg reversed exactly off the .618 retracement of the AB leg, which was at 34 3/16 (pt. C). When the BC leg reverses exactly off a Fibonacci retracement, this should signal a highly probable reversal at the following potential reversal zone.

The time symmetry of the price legs was very close. The AB leg required 11 days to complete, while the CD leg was 9 days in duration. Although I would have preferred the time length be exact, the symmetry was quite nice. Also, the slope of each leg was similar and each price leg was very distinct. The AB=CD and the 1.618 of BC were indicating that a potential set-up at 22 1/2

I have included this enlarged candlestick chart of the potential reversal zone. If you were looking to go long Compaq, when the stock sold off below 25, you should have been paying close attention to the price action.

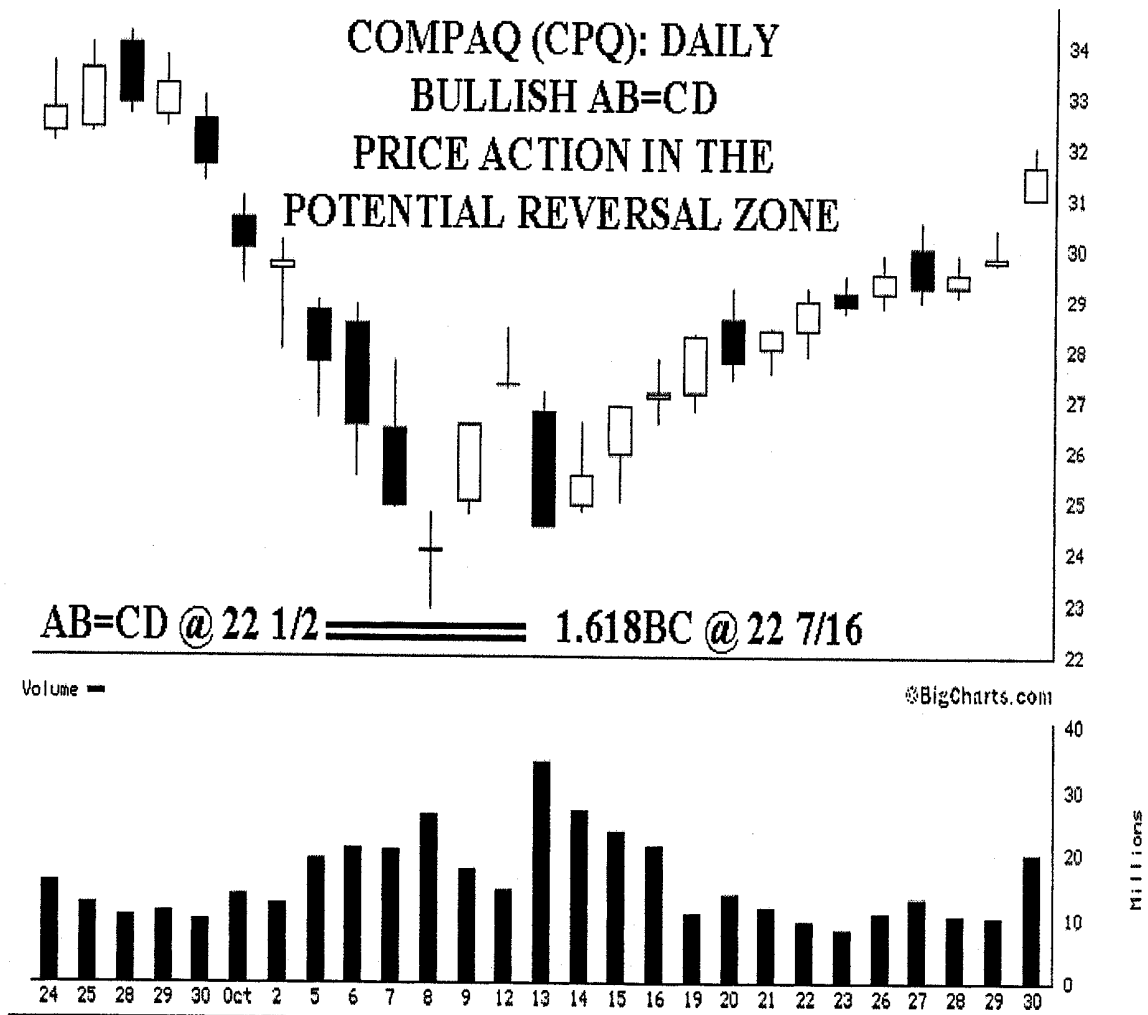

Although the stock did not complete an exact AB=CD pattern, it did reverse within a point of the potential reversal zone. The distance of the CD leg was $11 \frac{1}{4}$ points, and it reversed at $22 \frac{15}{16}$. This execution might have been tricky, since the stock did not complete the exact AB=CD. In situations like these, it is prudent to wait for some clear confirmation of a reversal before entering the trade.

Despite the fact that Compaq did not complete the exact AB=CD pattern, reversing only $\frac{1}{2}$ of a point shy of the projection, the stock provided significant bullish signs. The best indicator of the reversal was the doji that formed just above the potential reversal zone. The reversal was definitely confirmed the following day after hitting the low at $22 \frac{15}{16}$, as the stock gapped up and closed well above the previous day's price action.

Within a week, the stock was clearly breaking out to the upside. The convincing bullish price action of higher highs and higher lows was very substantial. So, even if you missed the reversal day, the gap up on the open of trading the next day should have indicated that the bullish trend was underway.

The next example of Oxford Health Plans completed a near perfect bullish AB=CD pattern. This was a very harmonic set-up because the 1.27 projection of the BC leg converged at the same point as the completion of the exact AB=CD. The stock reversed after exceeding the exact projection by a $\frac{1}{4}$ of a point.

The AB leg was $5 \frac{3}{4}$ points. The stock retraced this move and reversed exactly at $.786$ of the AB leg, which was at $19 \frac{1}{4}$ (pt. C). Such an exact reversal off a Fibonacci number indicates that this pattern is potentially very harmonic. The stock sold off and reversed just after hitting a low of $13 \frac{1}{4}$. Thus, the CD leg was 6 points, which was only an $\frac{1}{8}$ point longer than the AB leg.

The pattern was closely symmetrical in time as well. The AB leg required 11 days to complete, while the CD leg needed 14 days to complete. Although the time was not exact, the harmonic projections clearly indicated an opportunity to buy the stock around $13 \frac{1}{2}$.

Oxford Health Plans was down sharply the day that it hit this area, as evidenced by the large bearish candlestick. In fact, it gapped down on the open. So, you might have waited a day for the price action to confirm the reversal. The next day clearly indicated a reversal at hand, as the stock did not continue to decline. Within a few days, the stock rallied sharply. The reversal yielded an excellent profit, as the stock rallied almost 40% within the next two weeks.

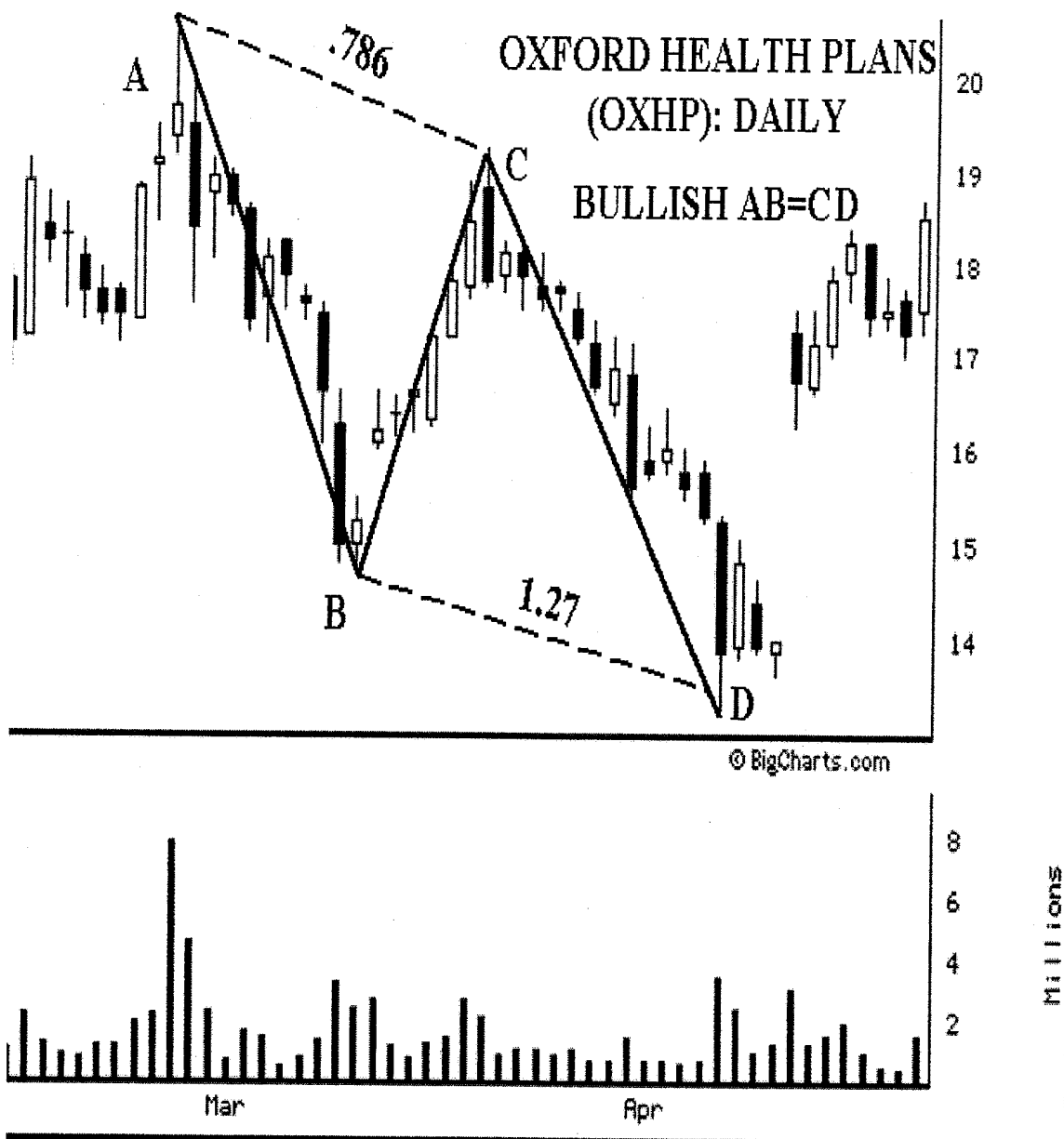

This ideal AB=CD occurs frequently in many stocks, although it is an incredibly simplistic pattern. It is important to recognize the significance of the AB=CD pattern, because it will get you to “buy low and sell high.” Let’s look at another example.

The following chart of Procter and Gamble is a great example of an almost exact AB=CD. The stock sold off sharply during the summer of 1998, as it lost over 25% of its value within a few months. However, the price action was quite harmonic.

The stock sold off from its high in July at 94 (pt. A) to a low in the beginning of August at 75 5/8 (pt. B), forming the AB leg. Procter and Gamble bounced a bit and then reversed after slightly exceeding the .382 retracement of the AB leg. Projecting an equivalent leg down from point C indicated that the exact AB=CD pattern would complete around 65.

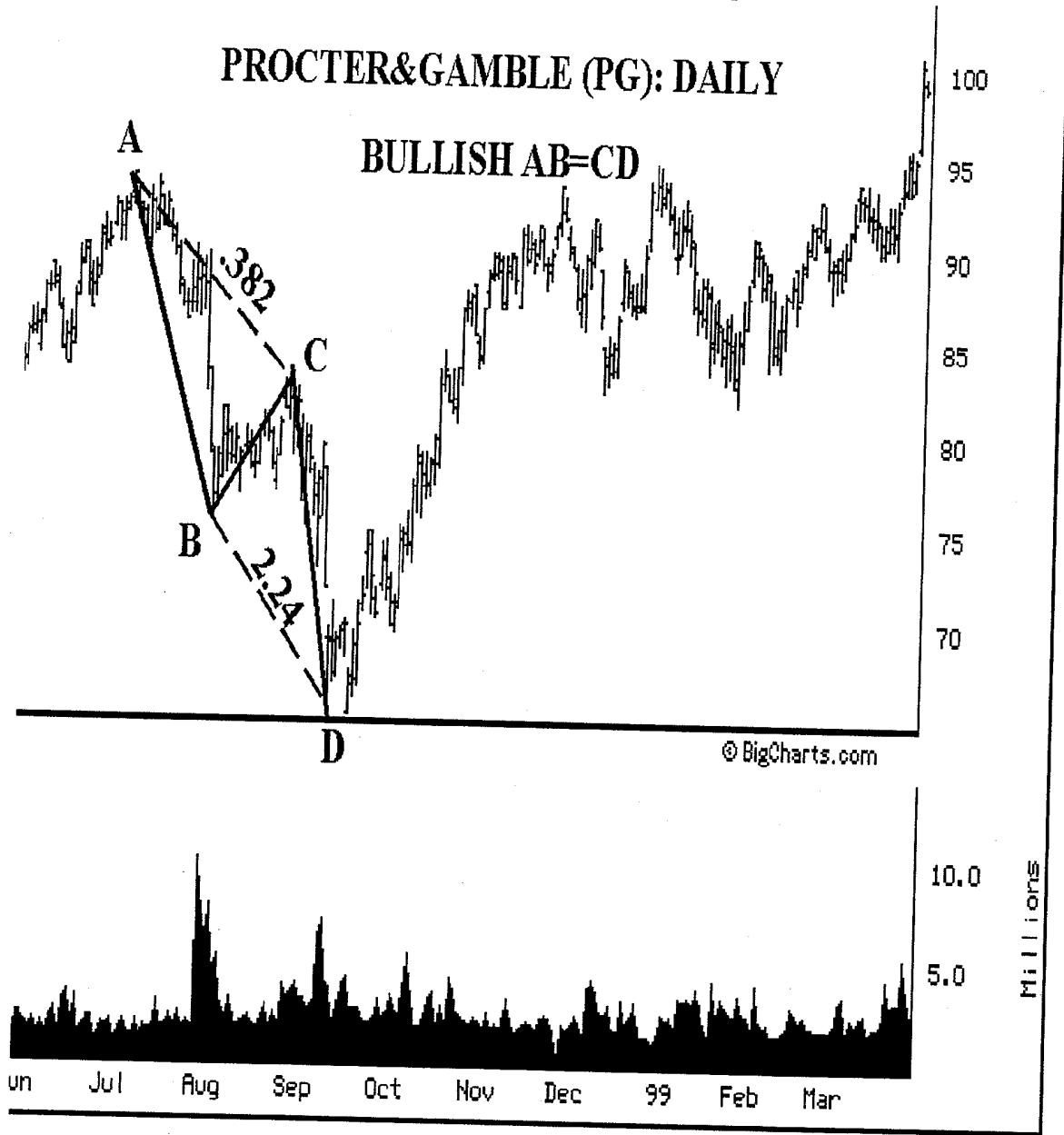

Although there were not any primary Fibonacci projections converging exactly in this area, the 2.24 of BC was calculated at 66. This is a good example of the secondary Fibonacci numbers complementing a clear pattern. So, when the stock sold off into this area, you should have been

paying close attention for a potential buying opportunity. I have included the following enlarged chart that clearly shows how the stock bounced off this potential reversal zone.

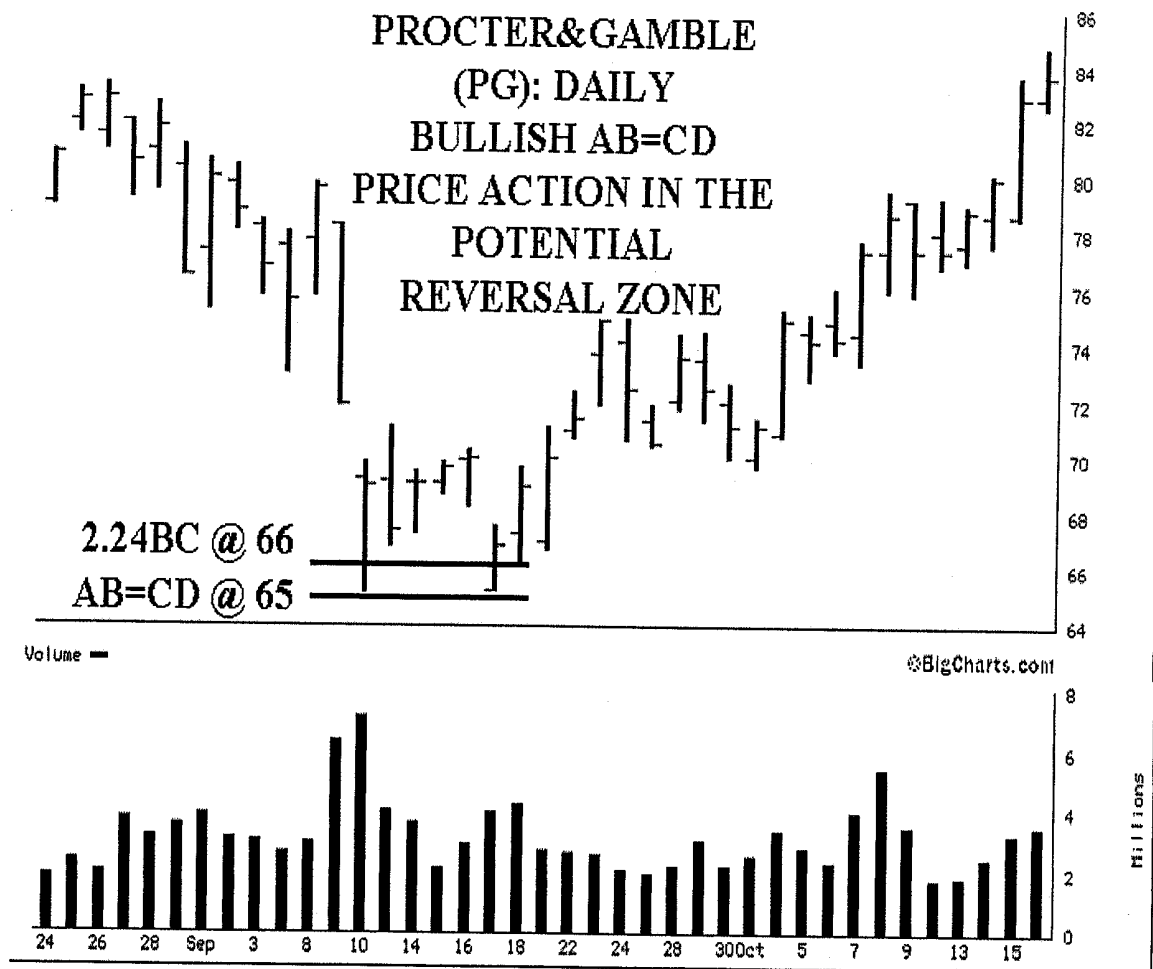

The price action was quite strong on the day Procter & Gamble hit this area, especially since the stock gapped down and possessed an extreme price range. Despite these warning signs, the stock reversed just shy of the exact AB=CD completion point. The AB=CD completed at 65 1/8, and the stock reversed at 65 1/4. As far as I am concerned, an 1/8 of a point shy is essentially an exact AB=CD.

Even if you missed the opportunity on this day because you were waiting for the exact AB=CD to complete, the reversal provided clear signals of a reversal. Within a week after the reversal, the stock headed higher. This resulted in a significant profit, as PG rallied over 25 points during the next three months.

This stock chart is another great example of a bullish AB=CD pattern that appeared in Fannie Mae. Fannie Mae completed an almost exact AB=CD pattern on the following daily chart.

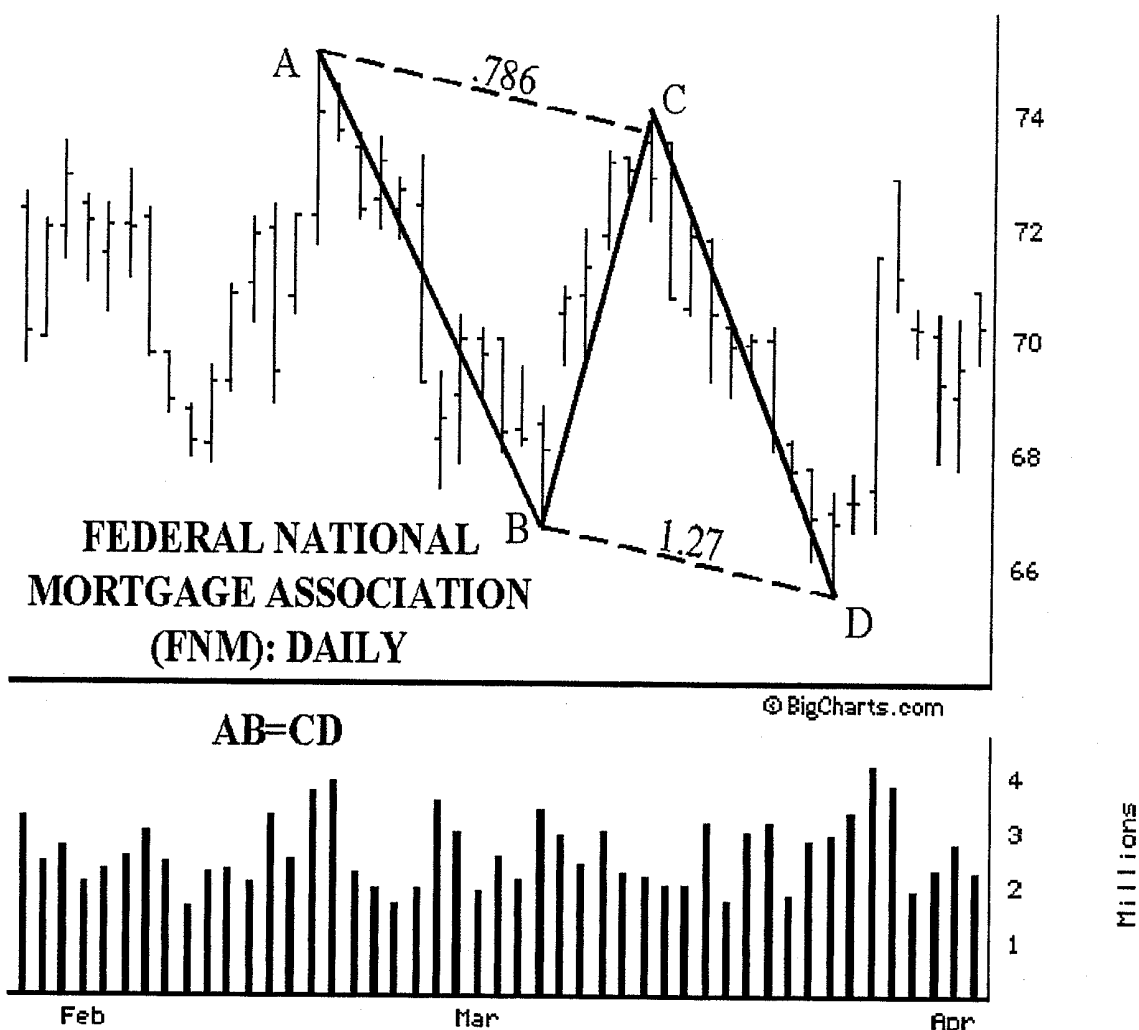

The distance of the AB leg was $8 \frac{3}{8}$. The stock reversed at point D, just $\frac{3}{16}$ past the exact completion of the AB=CD pattern. The CD leg was $8 \frac{9}{16}$ points, and it reversed at $65 \frac{1}{2}$. It is important to note that the 1.27 projection of the BC leg completed at $64 \frac{3}{4}$. So, the potential reversal zone in this general area was between $64 \frac{3}{4}$ to $65 \frac{3}{4}$.

The AB and CD legs were very symmetrical in time as well, as each leg was almost equivalent. The time down for the AB leg was 12 price bars, while the CD leg was 10 bars. It is important for the time of each leg in an AB=CD pattern to be closely equivalent. However, it is not necessary for the legs to be exact in duration for the pattern to be valid.

These examples illustrate the effectiveness of the bullish AB=CD pattern in determining significant buying opportunities. The patterns and the Fibonacci projections clearly define the areas where reversals can occur. Although exact AB=CD patterns do occur, it is important to understand that the reversal at point D should occur within approximately a point of the equivalent AB leg. Therefore, you should use the pattern to define the general area of the potential reversal zone. As the stock approaches this area, you should get ready to buy.

Bearish AB=CD

In the bearish AB=CD pattern, the points must be aligned exactly as the illustration shows. Point A must be the lowest point and point D is the highest point. Also, I refer point D as the completion point of the pattern. So, when I refer to the "completion point," I mean point D.

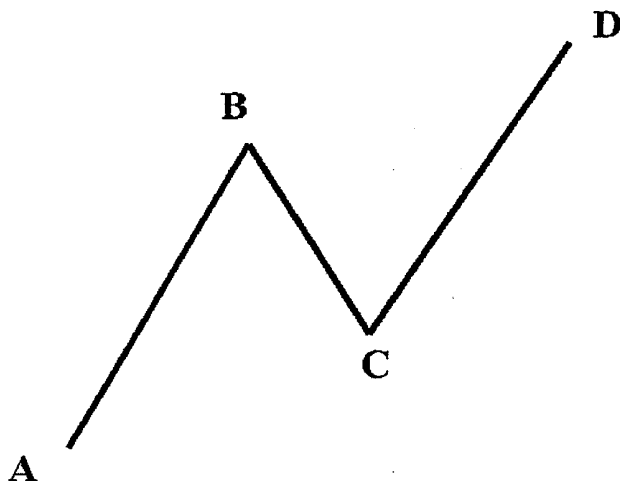

BEARISH AB = CD

SELL AT POINT D!

The bearish AB=CD pattern is difficult to integrate in your trading. When a stock is rallying, you think of a rising price as strength. Also,

referring to the diagram, when the CD leg rallies above point B, you would assume that this price action is bullish – thinking that the move is a breakout. Actually, the pattern is indicating that you should get ready to sell.

Preparing yourself to sell when this pattern emerges is more difficult than it seems. When I initially utilized this technique, I resisted selling at the completion point. I literally had to train my brain to execute in this manner. Much to my surprise, the pattern worked more times than it did not. It took me a while to truly execute the AB=CD effectively. Sometimes, I still hesitate and do not execute at my predetermined price. But, the more I adhere to this framework, the more my trading improves.

Bearish AB=CD Stop Loss

The bearish stop loss should be placed a point or two above the completion of the exact AB=CD. Although a stock might exceed the completion point, a valid reversal should occur relatively soon after hitting this area.

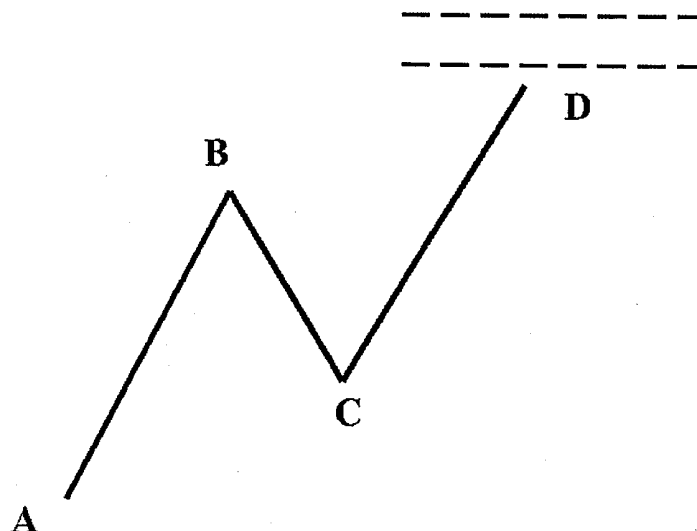

BEARISH AB = CD

STOP LOSS ABOVE POINT D!

As you study the following charts with AB=CD patterns, it is important to examine the price action in the area of the completion of the pattern. If the set-up is not a valid reversal, the stock usually will continue its rally and close above the completion area.

These signs are critical to observe because any valid reversal must materialize in this specific area where the CD leg is equivalent to the AB leg. Furthermore, valid reversals will possess price bars that confirm the change in trend. Conversely, invalid reversals will possess price action that continues in the predominant trend. This may seem over-simplified, but the price action will provide clear signals of its future direction.

Ideal Bearish AB=CD

In an ideal bearish AB=CD pattern, the AB leg will be the first move up. The BC leg will be either a .618 or a .786 retracement of the AB leg. After measuring the length of AB, you project the same distance from point C.

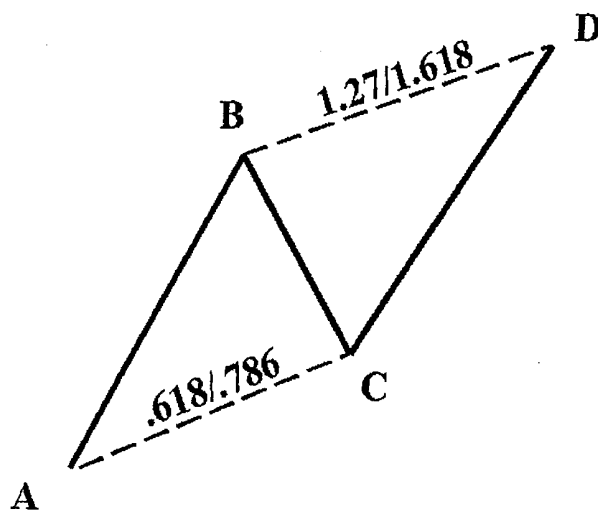

BEARISH AB = CD

SELL AT POINT D!

This measurement will indicate where the basic AB=CD pattern completes. It is also important to be aware of the time symmetry, as each leg should be closely equivalent in duration. Let's look at the following examples, as they will demonstrate clearly the framework of the pattern.

The first bearish example of Microsoft illustrates the pattern very well. The stock formed two distinct price legs that reversed almost exactly off the completion of the 1.27 of the BC leg. Microsoft formed this beautiful bearish AB=CD over a six month period. It is amazing that the stock can form such a clear pattern and a significant reversal like this. This pattern indicated the precise area where the stock could change course and begin a new downtrend.

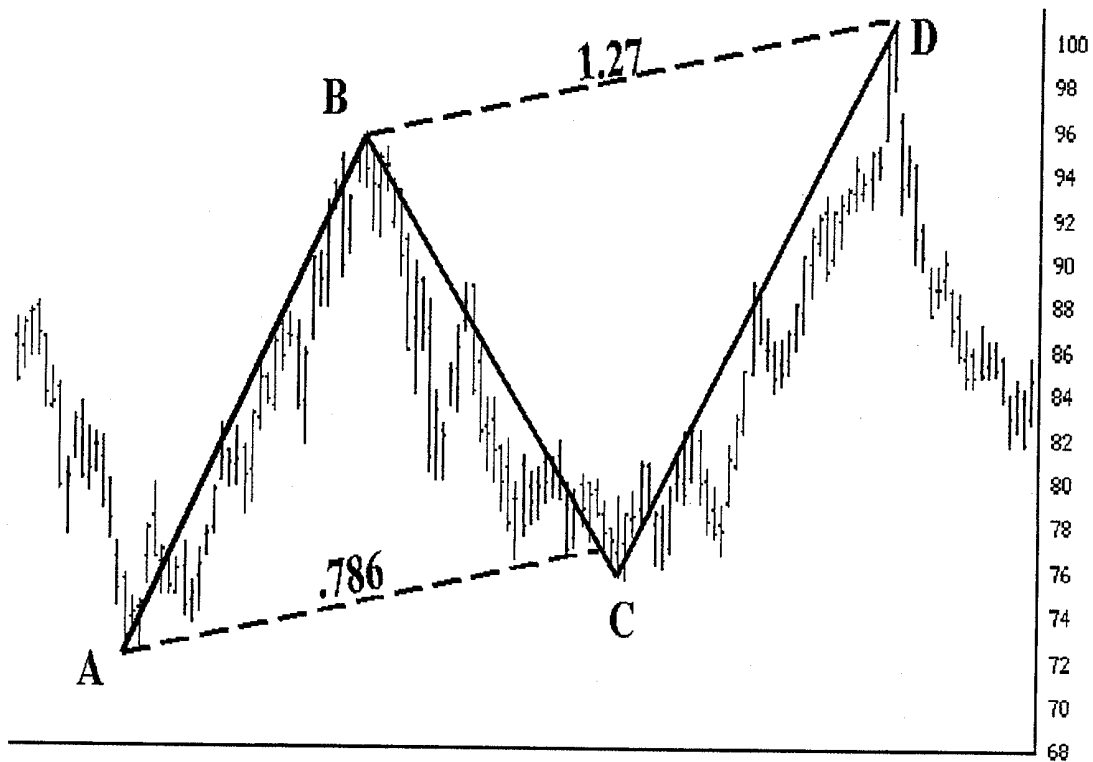

**MICROSOFT (MSFT): DAILY
BEARISH AB=CD**

©BigCharts.com

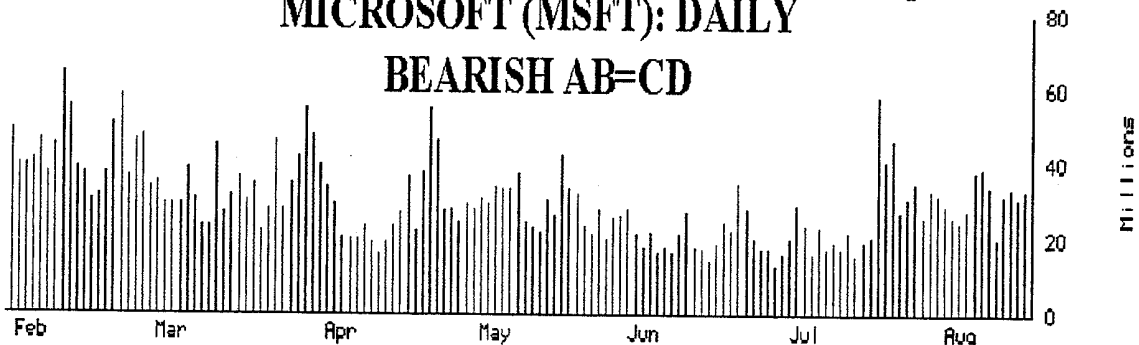

The AB=CD pattern was calculated to complete at 98 3/4. This area was complemented by the 1.27BC projection, which was at 101. Although the pattern was very clear, the stock gapped up on the open and rallied sharply on the day it hit the potential reversal zone. These two warning signs, an extreme price range and a price gap, would have kept you from selling on this day. But, on the next morning, the stock could not continue its move, as Microsoft topped at 100 3/4. On the day after the stock topped, the reversal was confirmed by the severe gap down on the open. In fact, the stock fell nearly 20 points within a month.

The following chart clearly shows the daily price action, as it hit the potential reversal zone. On the first day Microsoft hit the AB=CD completion target, the price action was very strong. But, on the next day the stock reversed after falling a 1/4 point shy of the 1.27BC projection.

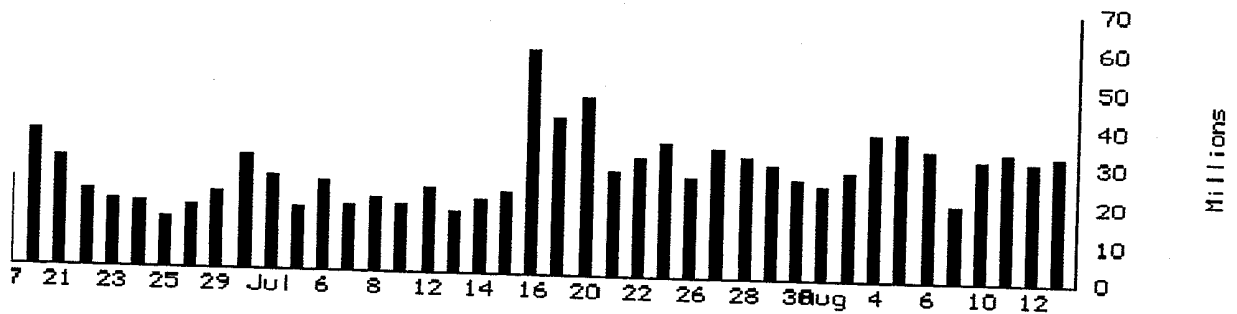
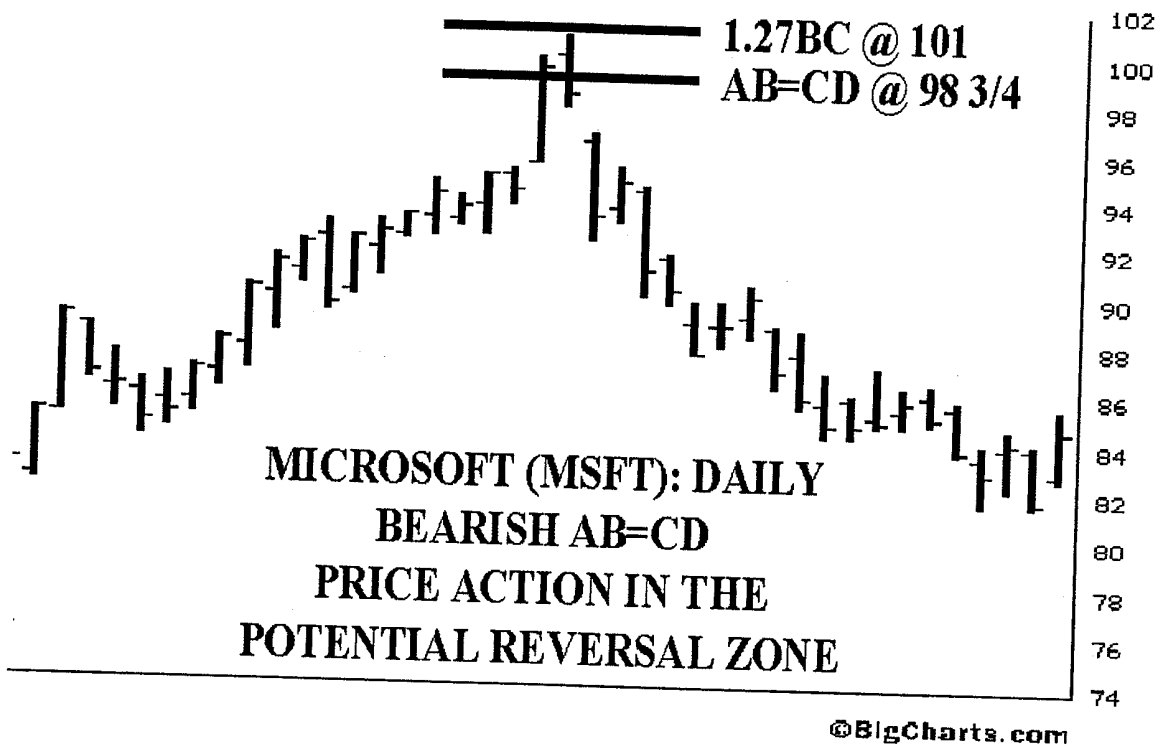

This example truly illustrates how a stock can reverse after hitting a harmonic area, despite strong price action. In Microsoft's case, the stock had been rallying sharply in the few weeks before the reversal. Also, the big rally that occurred on the day it hit the AB=CD completion point at 98 3/4 severely challenged the potential reversal zone.

I followed this set-up closely as it materialized. I personally thought that Microsoft was going to blow out this low-100 area and head higher. The price action seemed strong and there were several bullish stories regarding the company in the news. Better-than-expected earnings results, increased Internet revenues and a favorable court ruling painted a strong outlook for the stock. Despite this bullish forecast, the stock found very significant resistance just above the \$100 price level.

This is a classic case, where the excessive bullishness could be considered a contrarian indicator of the future stock price. In this example, the bearish pattern clearly indicated that the stock should be shorted or sold right around \$100 a share.

With so much bullish news in the media, you have to ask yourself: "how much better can it get?" I guess this was a situation where the media would say: "buy on the rumor, sell on the fact." I would say that it was a pretty clear selling opportunity because of the incredibly bearish pattern that possessed two harmonic numbers, which converged very close to each other.

The next example on this short-term chart of Home Depot illustrates the bearish AB=CD pattern, as well. The stock rallied in two distinct price moves that were approximately 8 points each. The stock sharply reversed after completing this pattern. Also, the individual price bars were very bearish at the completion of the pattern, indicating that a reversal was intact.

Home Depot lost 7 points in two weeks. Since this is a very short time frame, this set-up would be better suited for day traders looking for a quick move. Again, it is important to emphasize that the most critical number in this set-up is where the CD leg equals the AB leg. Although this pattern required secondary Fibonacci numbers to measure the price action, it still was a very harmonic set-up.

This set-up was harmonic because the pattern was almost exact, and the Fibonacci projection of the BC leg indicated a short-term selling opportunity around 66. The AB leg was 7 7/8 points, while the CD leg was 8 5/16 points. The 2.24 projection of the BC leg was at 66 1/4. The stock hit 66 5/16 and sold off. Clearly, when this stock hit 66, you should have been getting ready to sell.

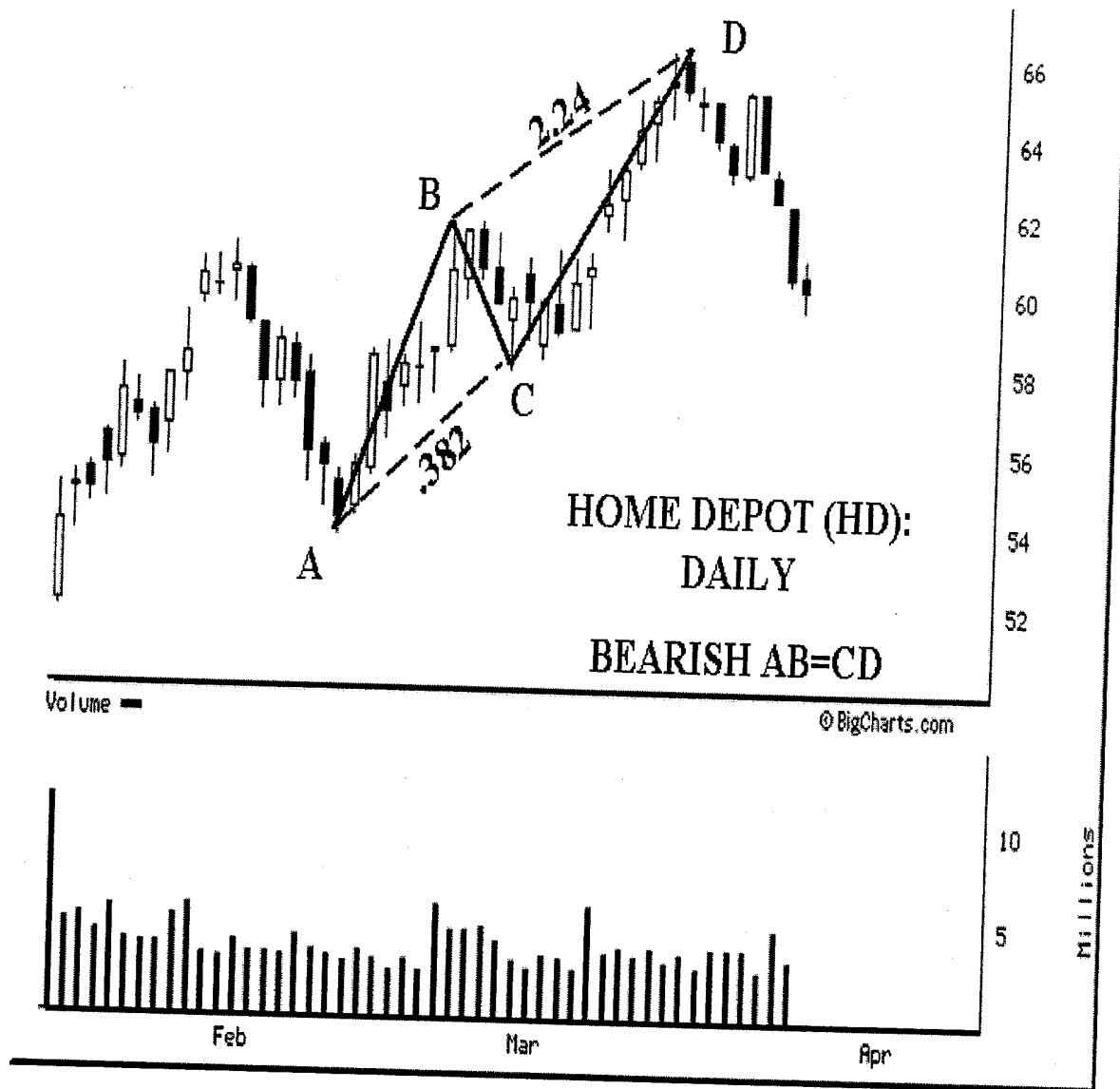

The next example of Intel is very similar to Microsoft. The stock formed a very distinct pattern that reversed almost exactly off the completion of the pattern.

Intel formed a very nice bearish AB=CD pattern. The stock reversed just below \$90 a share. In the weeks leading up to the reversal, Intel was rallying sharply. However, the stock experienced substantial resistance after hitting the potential reversal zone. The stock possessed an extreme range on the day it hit the 1.618 projection of BC at 84 1/4. Respecting this warning signal, you would have waited at least one day before executing the trade. On the day the stock hit the completion target of the AB=CD pattern, it gapped up on the open – another warning signal.

**INTEL (INTC): WEEKLY
BEARISH AB=CD**

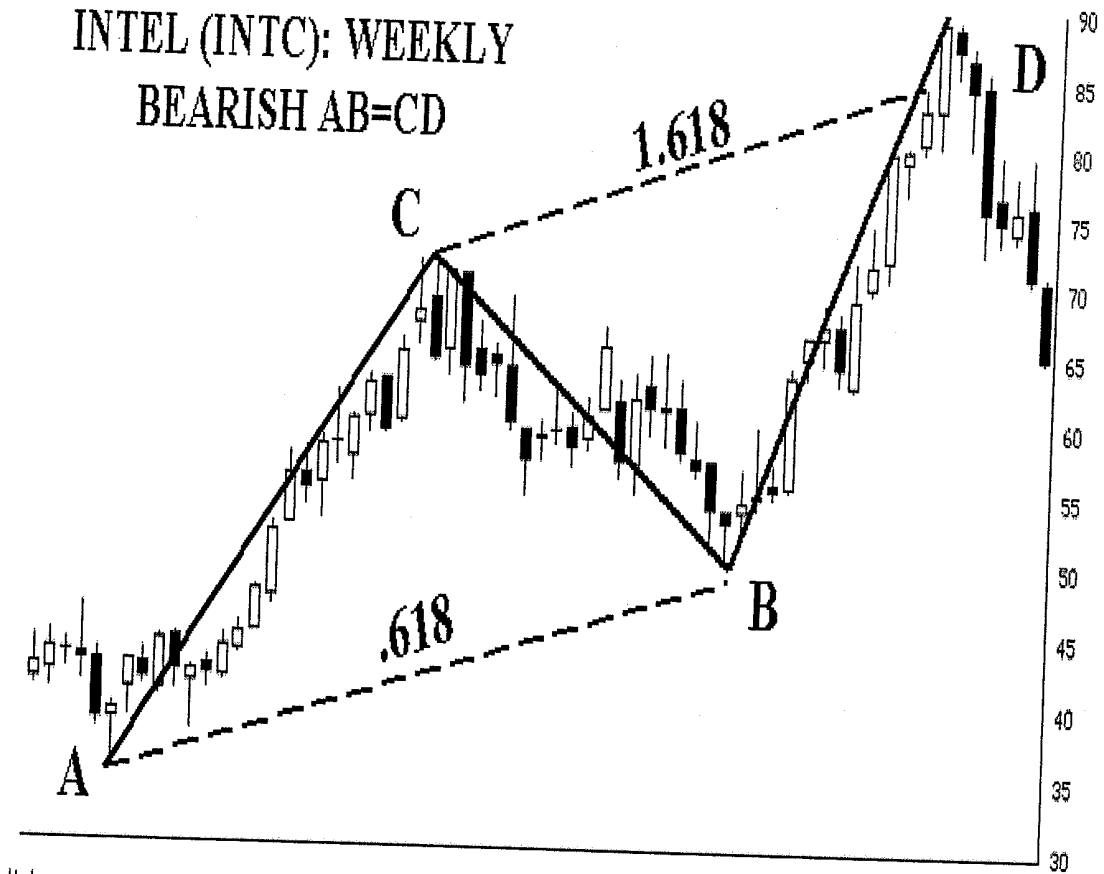

Volume —

BigCharts.com

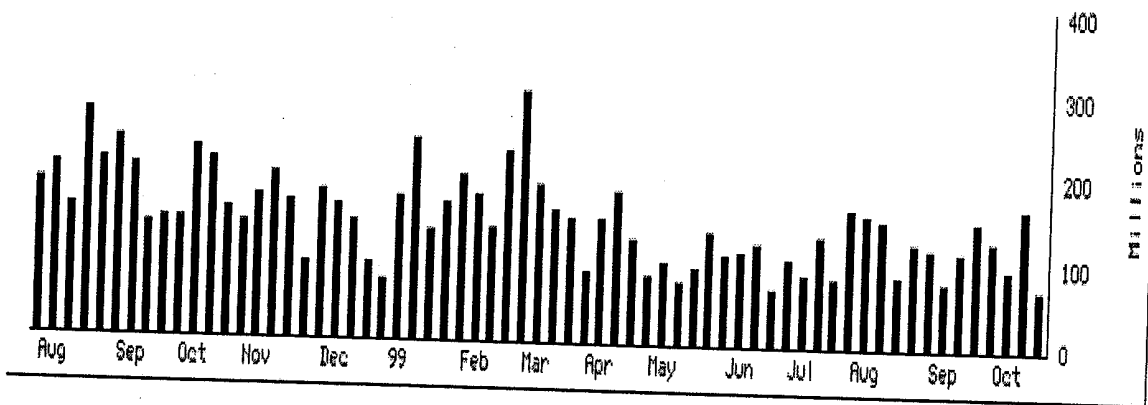

Although this price action seemed quite strong, the following day could not follow through on the upside. Within a few days, Intel broke down forming lower highs and lower lows. The following enlarged chart shows the price action in the potential reversal zone. Clearly, Intel stalled in this area. Furthermore, the stock formed mostly bearish price bars after topping out just above \$89 a share.

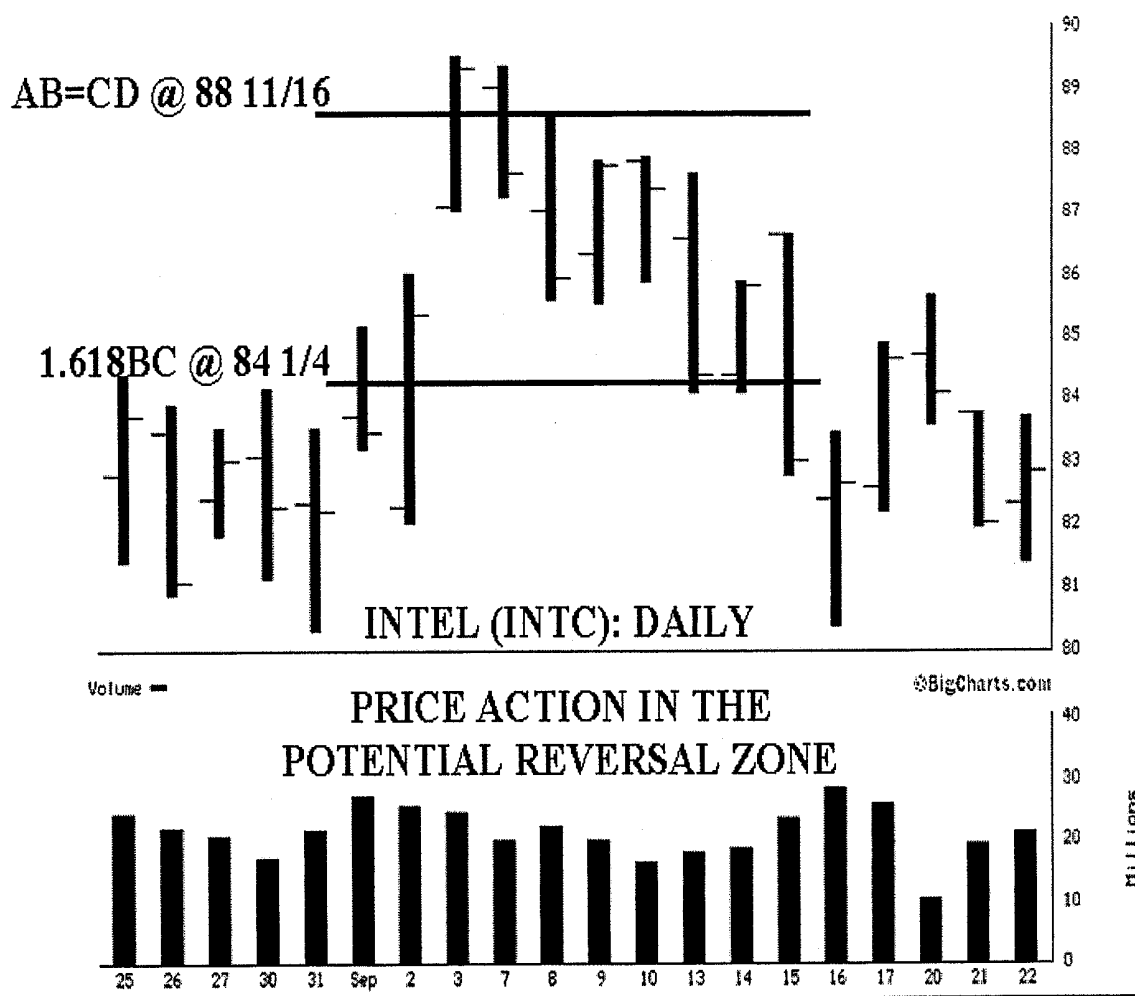

This situation was very similar to the example of Microsoft because the news in the media was excessively bullish. In this case, Intel was benefiting from higher DRAM prices and increased demand for personal computers. Again, I thought that Intel was going to blow out the potential reversal zone. But, after the stock broke down, I realized the reversal was valid. I bought September 85 puts on the open of trading two days after the reversal and made money.

The next example of GTE shows another clear bearish AB=CD pattern, except it is on a longer time frame. The pattern was very distinct and reversed just above the exact completion of the pattern. The AB leg was almost 24 points – 23 7/8 to be exact. The BC leg reversed at 46 9/16 (pt.C), falling short of the exact .786 retracement of the AB leg at 45 9/16. Projecting an equivalent move from point C, the potential reversal zone was calculated around 70.

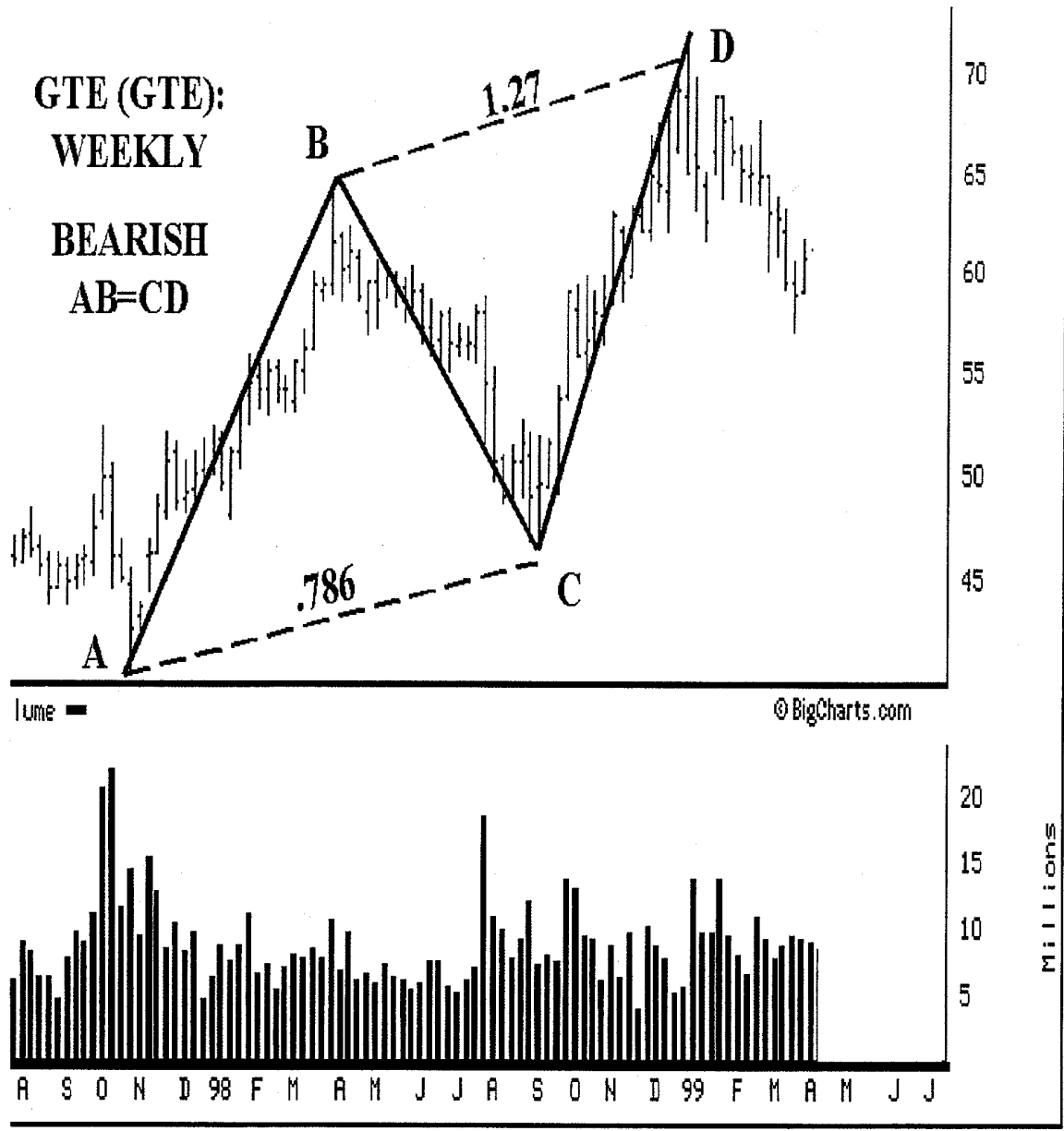

The completion of the AB=CD was also complemented by the 1.27 projection of the BC leg at 69 3/16. GTE rallied strongly, as it slightly exceeded the exact AB=CD, projected to complete at 70 7/16. Despite the strong price action, the stock reversed at 71 13/16. The reversal was confirmed in the following few weeks, as GTE clearly broke down.

This was a very significant pattern, especially since it was so clear and formed over a year. I would have preferred to see a more symmetrical time sequence for each leg. The AB leg was 23 weeks, while the CD leg was 18 weeks.

Despite this slight discrepancy, the AB=CD pattern clearly gauged the potential reversal zone. It defined a very specific area – around 70 – to sell or short the stock. Since the stock experienced significant difficulty rallying through the potential reversal zone, this price action indicated serious resistance. The following candlestick chart shows the price action in the potential reversal zone.

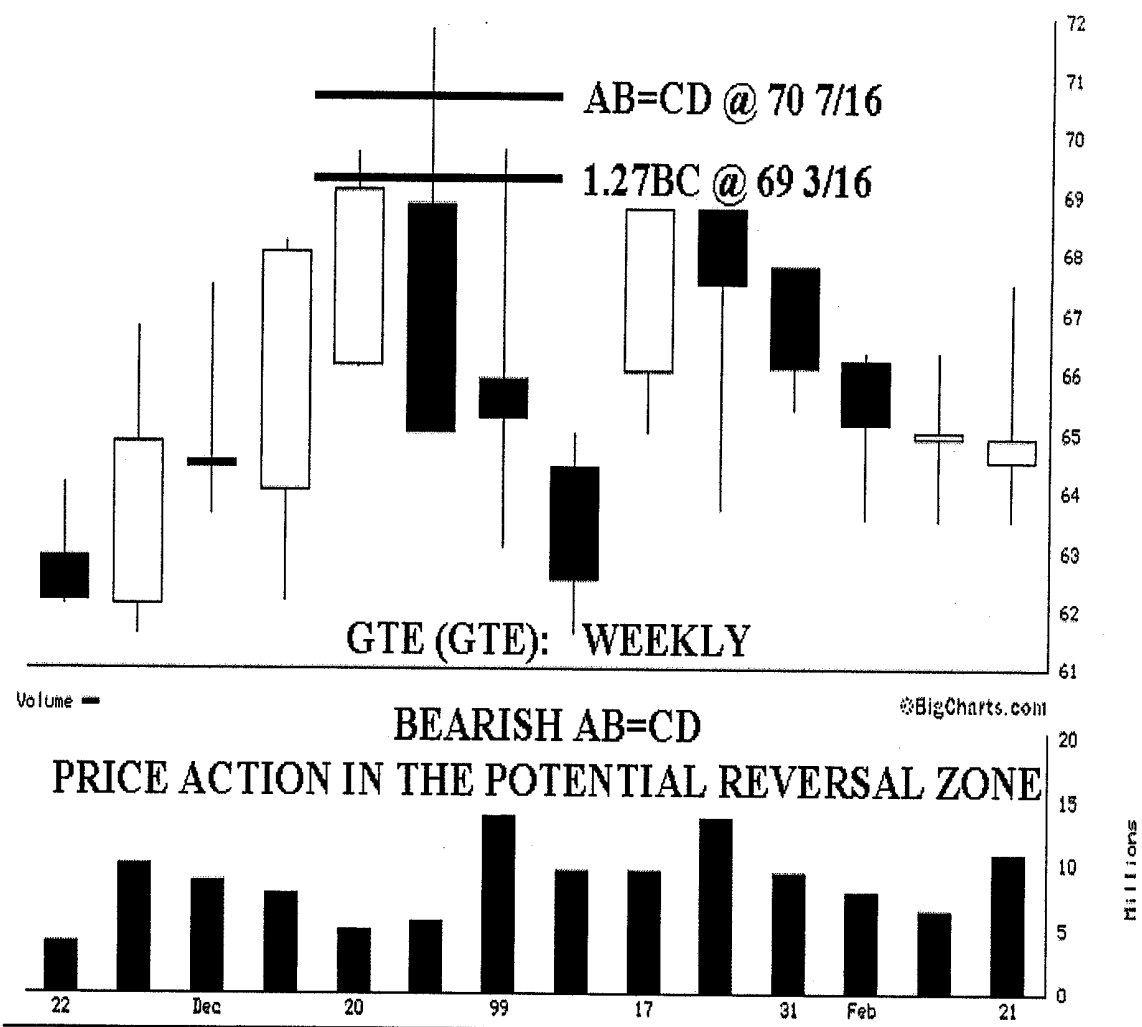

As you can see, GTE reversed sharply on the week it hit the completion of the AB=CD. The following week also validated the harmonic area as a change in trend, because the stock clearly broke down. Another interesting aspect of this reversal was the large bearish candlestick that formed after the stock hit the AB=CD completion point. Also, GTE could not rally into new highs, and it continually formed bearish price bars. Such price action is critical in gauging the stock's trend and validating the reversal.

Understanding the AB=CD Pattern

In my opinion, there are several mental obstacles that impede the understanding of the AB=CD pattern. When the AB=CD is developing, it is difficult to believe, especially when the trend in place seems to be very strong. In our bullish example, as the CD leg is selling off, it might become difficult to perceive the buying opportunity because it seems like the downtrend will continue. As the selling continues, our brain will interpret lower prices as a weaker stock. Conversely, when a bearish AB=CD pattern develops, we naturally perceive higher prices as strength. So, when the stock continues to climb, we get greedy, and it is very easy to get caught up in all of the money we are making. Unfortunately, the pattern is telling us to sell. Therefore, it is important to train your brain to think within a defined framework of AB=CD and to execute trades accordingly.

Another mental obstacle of the AB=CD pattern is that it just seems too simple. I know that when I first began employing the AB=CD technique in my trading, I had a difficult time believing that price action would act this way. I had to witness many examples of the AB=CD pattern before I truly believed it. Even after I believed that the pattern worked, I had to mentally reinforce the AB=CD framework.

It was not until I actually wrote on the stock charts the AB=CD pattern that I began to execute at point D. For example, if I was looking to buy, I would draw the pattern and write: "Buy at D!" In fact, I would draw the pattern on a piece of paper, over and over again! Also, as I was beginning to ingrain the pattern in my brain, I repetitively said to myself: "AB=CD, AB=CD, AB=CD!" Amazingly enough however, there were even times when I would write the AB=CD pattern on the stock chart and still jump in before the pattern was complete. And then, the stock would bounce almost exactly off the completion point. I guess it was not until I was burned by these mistakes that I truly learned the importance of the AB=CD framework. Therefore, I can't emphasize enough the importance of ingraining this pattern in your brain.

One of the most important reasons to think in an AB=CD framework is because it gets you to buy low and sell high. It is incredible how such a simple pattern can be very difficult to execute. But, I guarantee, as for my own experience, not thinking within the AB=CD framework has cost me money – lots of it! So, resist it if you must, but you will not begin to be consistently profitable until you utilize the AB=CD pattern.

When analyzing potential reversal zones, the $AB=CD$ is one of the most important numbers to consider. In fact, I believe the completion of an $AB=CD$ pattern within a harmonic reversal zone is a minimum requirement for a trade signal. Although this has kept me out of some very profitable trades, I usually will not enter a trade unless an $AB=CD$ is present. I continually have observed the pattern gauge price action accurately, by indicating the specific areas to examine. In addition, a potential reversal zone that includes an $AB=CD$ with other Fibonacci calculations provides a very significant area for a high probability trade opportunity.

Once this pattern is identified, it is important to calculate the 1.27 or 1.618 projection of the BC leg. Usually, one of these numbers will be close to the completion point of $AB=CD$. So, it is essential to examine this area for a potential reversal. Although the $AB=CD$ seems very simplistic, it works out more than it does not. Therefore, it is extremely important to utilize this framework as the fundamental means of identifying potential trade opportunities.

Alternate Projections of the $AB = CD$ Pattern

Although the $AB=CD$ pattern is a great set-up when each leg equals the other exactly, there are many situations where alternative Fibonacci calculations are required to clearly define the potential reversal zone. Although there might be a clear pattern developing, it is not uncommon for the $AB=CD$ to be unequal. These alternate projections should merely complement an area that possesses other harmonic numbers. As I will discuss in the section on patterns, these alternate projections are effective in defining potential reversals.

1.27 or 1.618 $AB = CD$

When the equivalent $AB=CD$ completion point is blown out, the 1.27 or 1.618 can be used to determine other potential reversal points. These alternate calculations are not difficult to calculate. Depending upon which number is used, multiply the AB leg by either 1.27 or 1.618 and project that distance from point C. This calculation should converge with a Fibonacci projection - usually a 1.618 or 2.24 - of the BC leg.

Alternate Bullish 1.27 or 1.618 AB=CD

The bullish alternate projection is useful to gauge other potential reversal areas for price moves that exhibit a clear AB=CD pattern. The CD leg usually will experience an extended decline that reverses off the 1.27 or the 1.618 of the AB leg.

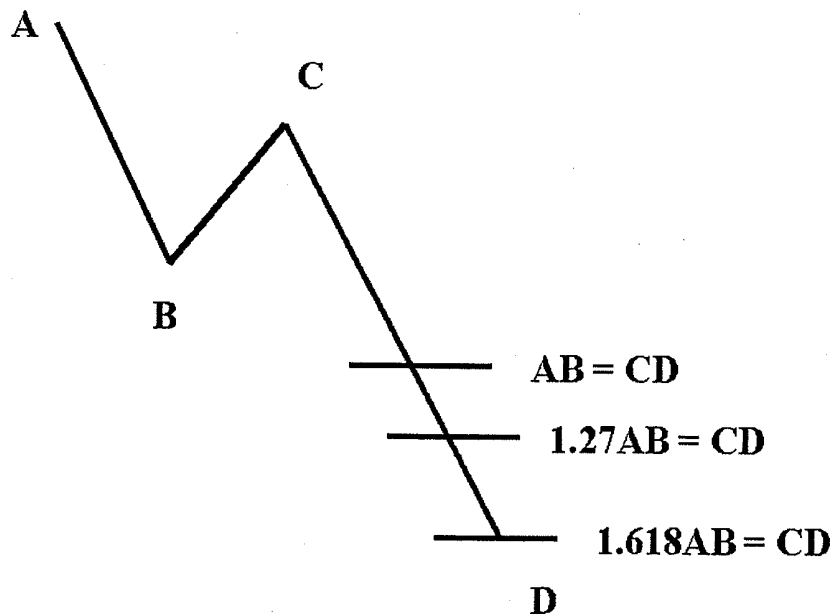

BULLISH 1.27 OR 1.618 AB = CD

BUY AT POINT D!

When other Fibonacci projections are present with an alternate completion point, you should watch this area closely for a potential reversal. Let's look at an example of the 1.27 alternate projection.

The following long-term weekly chart of Haliburton clearly possessed a harmonic set-up around 30. At this point, you might be wondering why the exact AB=CD was not considered for this set-up? The exact AB=CD was projected to complete at 37 1/4. Clearly, Haliburton was experiencing extreme selling pressure in this area, as evidenced by the abnormally large price bars. However, there were several other harmonic calculations that converged near 30.

HALIBURTON (HAL): WEEKLY

BULLISH 1.27AB=CD

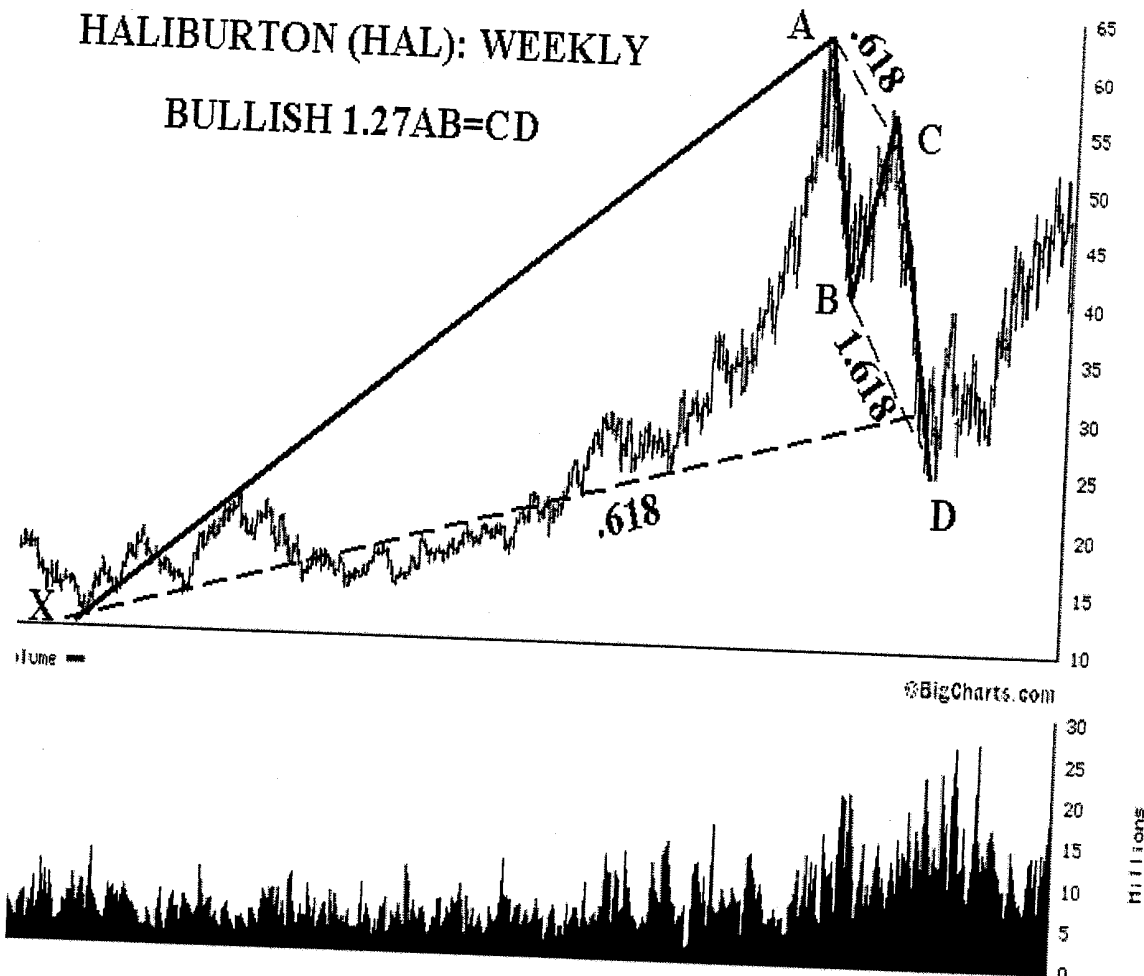

One of the most significant numbers was the major .618 retracement projected from the '92 low at $10 \frac{7}{8}$ (pt. X) to the '97 high at $63 \frac{3}{4}$ (pt. A). The .618 falls just above 31. Also, the 1.618 of the BC leg was calculated to complete at $30 \frac{1}{2}$. So, these two calculations were indicating a better potential set-up just above 30. When this situation occurs where the AB=CD does not converge with several other numbers, you should use the alternate projection of the AB=CD.

In this case, the 1.27 of the AB leg projected a completion point for CD at 28. So, with this additional calculation, the potential reversal zone has three numbers within three points. Therefore, the potential reversal zone was between 28 and 31.

In such a long-term chart, these numbers are close enough for a good set-up. The alternate calculation of the 1.27 of the AB leg proved to be a

good entry point for a buy, as the stock reversed at 27 1/16 - which was within a point of the projection.

This chart is an excellent example of an alternate calculation accurately gauging the price action. The 1.27 alternate projection proved to be good support. Another important aspect of this chart is that the congregation of numbers generally indicated the area to buy.

The three harmonic calculations that converged around 30 on such a long-term chart proved to be a good opportunity to buy this stock. Remember, when multiple harmonic projections occur within a defined area, you must consider that a highly probable area for a reversal.

These type of set-ups occur with the 1.618 alternate projection of $AB=CD$, as well. Although I did not provide an example, I believe you get the picture with the example of Haliburton. The most important aspect is that other Fibonacci projections converge in the same area as the alternate $AB=CD$.

Bearish Alternate 1.27 or 1.618 $AB=CD$

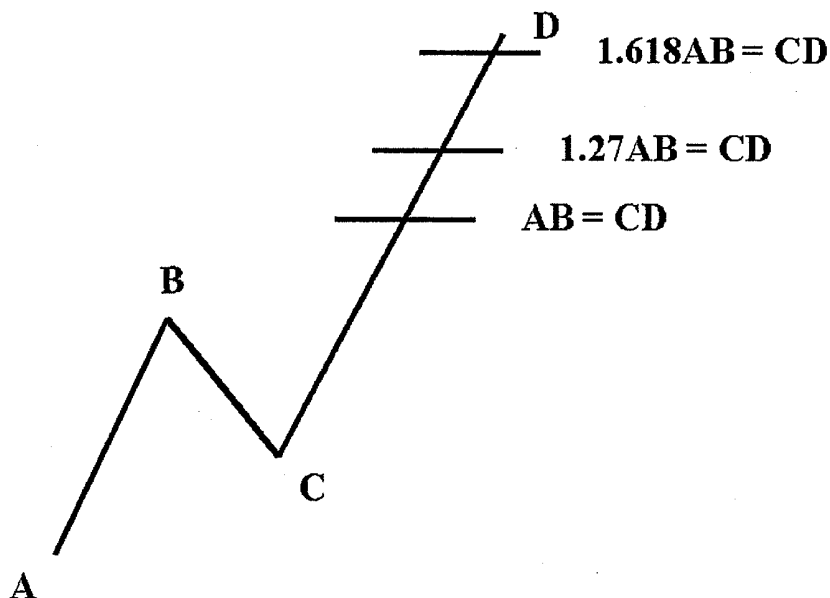

BEARISH 1.27 OR 1.618 $AB=CD$

SELL AT POINT D!

The bearish alternate AB=CD projection is extremely useful in gauging a clear AB=CD pattern that becomes extended. Again, it is important to observe other harmonic calculations around this same area. But, the alternate 1.27 or 1.618 projection can accurately define other potential reversal zones.

The following chart of Gateway Computer illustrates the effectiveness of the alternate AB=CD projections. This pattern developed over a four-month period and reversed almost exactly off the 1.27 of the AB leg. This area was complemented by the BC projection, and it suggested a potential selling opportunity above 80.

GATEWAY COMPUTER (GTW): DAILY

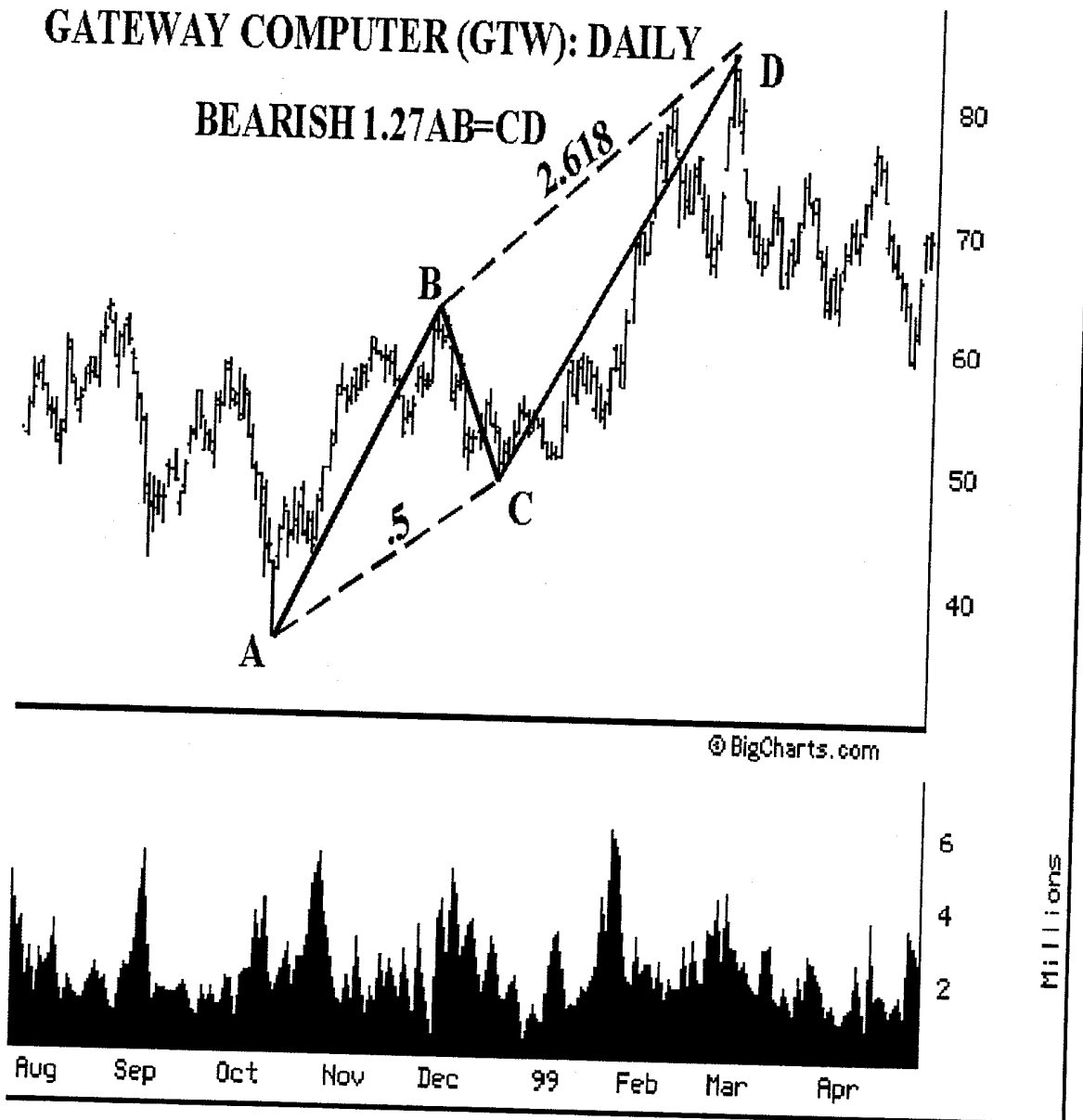

Again, you might be wondering why the exact $AB=CD$ was not a valid execution point? The AB leg was $26 \frac{7}{8}$ points. Projecting this distance from point C results in the completion of the pattern at $76 \frac{1}{8}$. Clearly, when the stock hit this area, the price action was quite strong, due to the bullish gap on the open and the extremely large price bar on the day it hit this area. These warning signals would have kept you from taking the trade. Even if you waited a day, the price action continued higher, which also indicated that the stock was strong.

The alternate projection of 1.27 $AB=CD$ was calculated at $83 \frac{3}{8}$. This calculation was complemented by the 2.618 projection of the BC leg at $85 \frac{1}{4}$. So, when Gateway reached this area, it was in another potential reversal zone that indicated a selling opportunity.

Unlike the time when the stock hit the exact $AB=CD$, this stock started to reverse at the alternate projection, and it provided some clear reversal signs. The stock began to breakdown, as evidenced by the reversal price bars and developed a bearish continuation pattern of lower lows and lower highs. So, if you waited a day, the following price action indicated that a reversal was occurring. The stock gapped down three days after the reversal was complete, which definitely signaled that a bearish trend was intact.

These alternative projections usually will not be as good of an indicator as the equivalent $AB=CD$. But, they are effective harmonic calculations when the $AB=CD$ has been clearly exceeded. It is very common to utilize the 1.27 or the 1.618 to project the CD completion point to clarify potential reversal zones. In particular, these alternate projections are extremely useful when combined with other significant Fibonacci projections.

.618 or .786 of $AB = CD$

Another alternate projection of the $AB=CD$ pattern is to utilize the .618 or .786 of the AB leg to determine the CD completion point. These situations occur when the AB leg possesses an extreme price move, yet the pattern still possesses two symmetrical price legs.

Although these patterns are fairly uncommon, they do occur. The completion of the shortened CD price leg is determined by multiplying .618 or .786 of the AB leg and projecting that distance from point C. Similar to the 1.27 or 1.618 projections, the .618 or .786 alternate calculation of the AB

leg should be used only when there is a distinct pattern and other Fibonacci projections occurring within a specific area.

Bullish Alternate .618 or .786 AB=CD

In a bullish alternate calculation, the .618 or .786 are useful to determine a potential reversal zone, especially when the AB leg has declined sharply. As I mentioned before, I like to use only the .786 projection of AB for the CD leg. Furthermore, there must be a primary Fibonacci number, usually a 1.27 that converges in the same area.

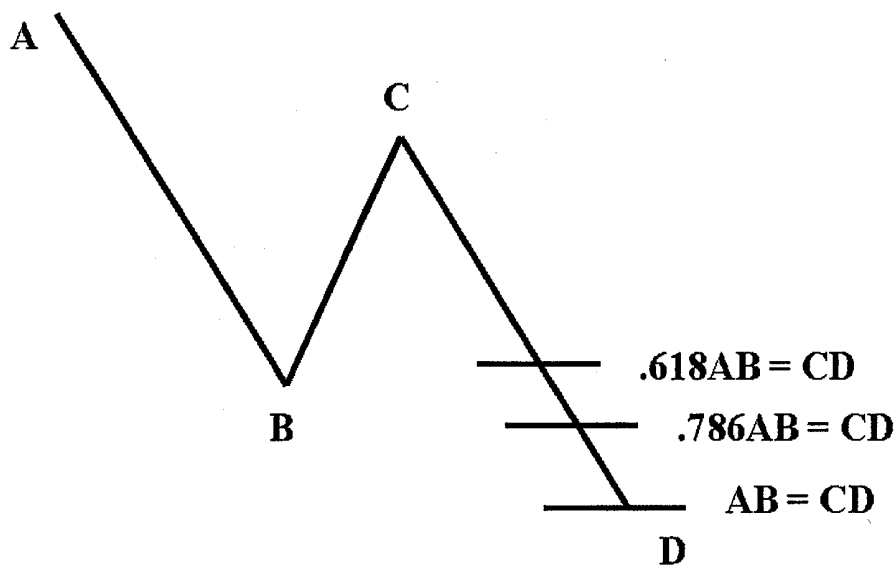

BULLISH .618 OR .786 AB = CD

BUY AT POINT D!

Similar to the 1.27 or the 1.618 alternate projections, the .618 or the .786 should be used only in conjunction with other harmonic calculations. Let's look at an example.

The following monthly chart of First Data Corp. formed a very distinct pattern that reversed almost exactly at the .786 projection of the AB leg. The set-up possessed two harmonic numbers that converged just below 20. The .786 alternate calculation of the AB leg was projected to complete at 19 1/2. This area coincided with a 1.618 projection of the BC leg at 18 3/16. The area provided significant support, as the stock reversed less than 1/4 point shy of the alternate projection at 19 3/4.

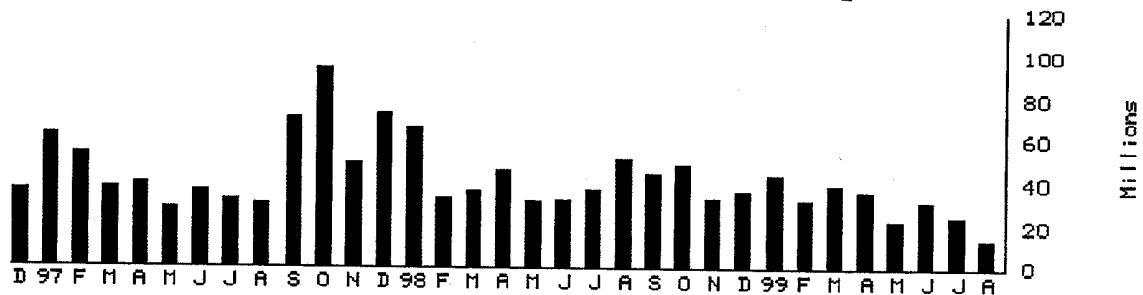
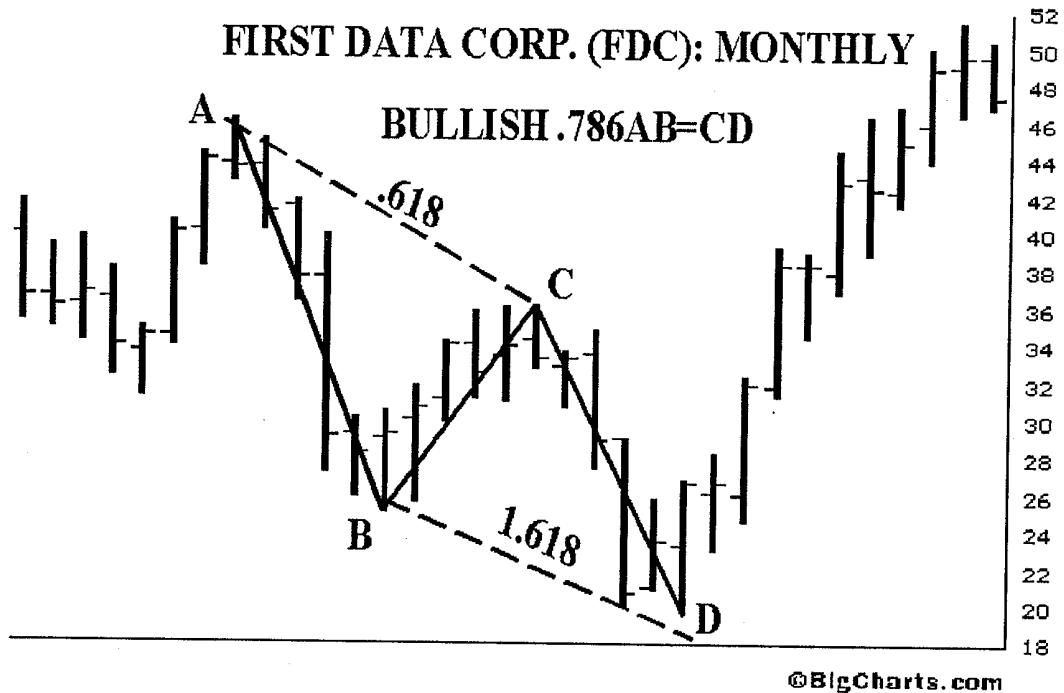

This is a very interesting chart, especially since the pattern was so distinct and it developed over a two-year period. Although the exact $AB=CD$ would have been an even clearer set-up, the alternate calculation defined the reversal area quite well. You could have waited for some definitive reversal signs before buying the stock. First Data Corp. provided excellent confirmation of the new uptrend, as the stock rallied higher for almost a year without breaking the prior month's low.

Bearish Alternate .618 or .786 AB=CD

The .618 or .786 bearish alternate calculation of the AB=CD pattern does occur frequently. I believe that this pattern is associated with false breakouts. Often, a stock will rally past point B but fail to continue higher. In this case, the stock usually reverses sharply because it could not break above the previous resistance.

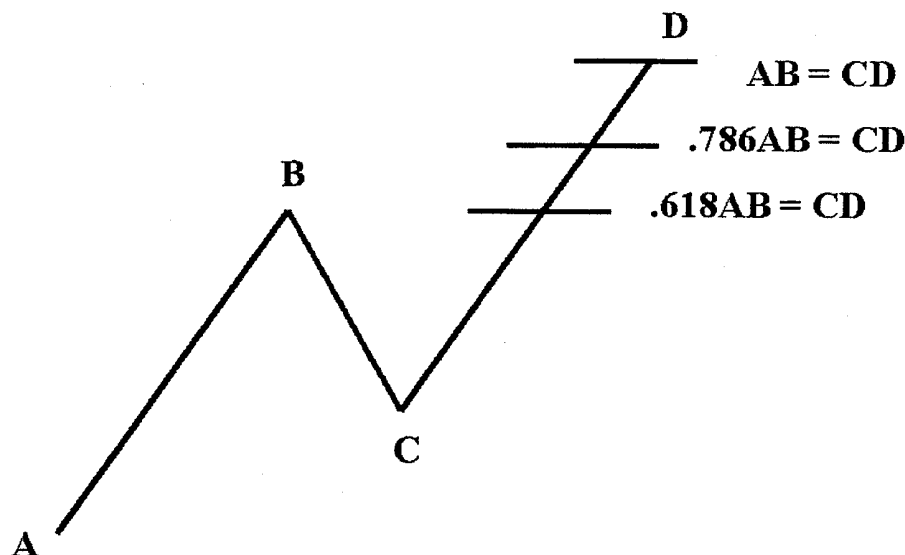

**BEARISH .618 OR .786 AB = CD
SELL AT POINT D!**

Again, it is important to remember that these alternate calculations are most effective when other harmonic calculations converge in the same price area. Let's look at the following example.

Computer Associates formed a nice alternate AB=CD that reversed just past the .618 projection of the AB leg. The .618 of AB projected from point C resulted in a completion at $50 \frac{3}{8}$. This calculation converged with the 1.618 of the BC leg at $50 \frac{15}{16}$. The stock rallied to $51 \frac{5}{8}$ and reversed.

COMPUTER ASSOCIATES (CA): DAILY

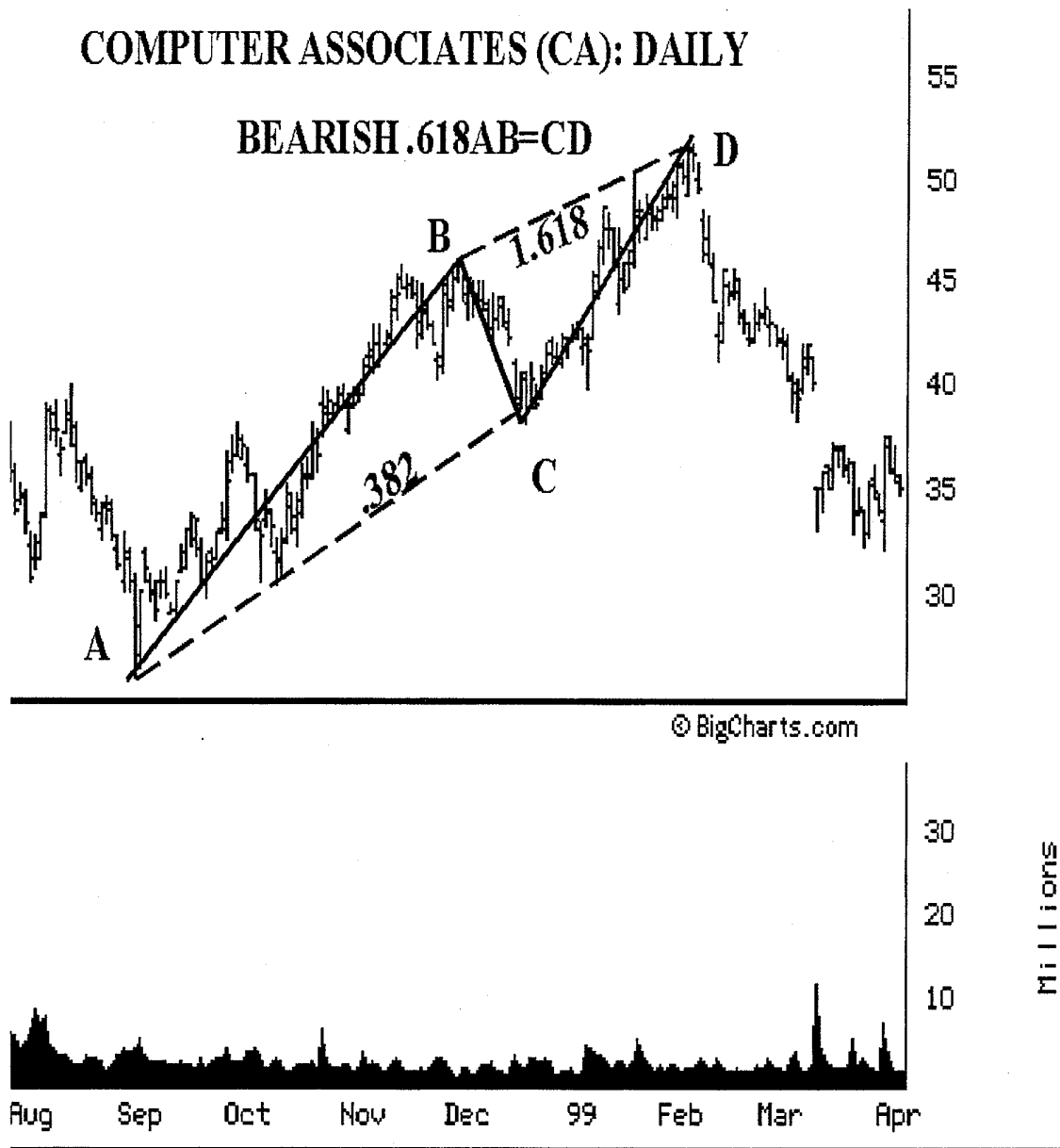

This potential reversal zone, between $50 \frac{3}{8}$ and $50 \frac{15}{16}$, proved to be difficult resistance for the stock. Within a few days after hitting this area, the stock declined sharply.

I can't emphasize enough that these alternate calculations should merely complement other harmonic projections. When a distinct AB=CD pattern is present, these calculations can provide more evidence of a potential reversal. Also, alternative projections utilizing the .618 or .786 are not as frequent as the 1.27 or 1.618 of AB leg. As I will illustrate in the section on patterns, they are most effective in defining critical turning points more clearly.

AB=CD with ab=cd

There many instances where a smaller ab=cd pattern will exist within one of the legs of a larger AB=CD. When this occurs, the smaller ab=cd will often complete in the same area as the larger AB=CD. Although it can exist in the first leg (AB) or even both legs, a smaller ab=cd usually will be found in the CD leg of the larger AB=CD. The existence of a smaller ab=cd will complement the other harmonic numbers and will help further define the potential reversal zone. I believe that the completion point of the larger AB=CD is more important than the smaller ab=cd. But, the completion point of an ab=cd pattern within a larger AB=CD does signify an extremely harmonic set-up, and it can be a crucial potential reversal point.

Bullish AB=CD with ab=cd

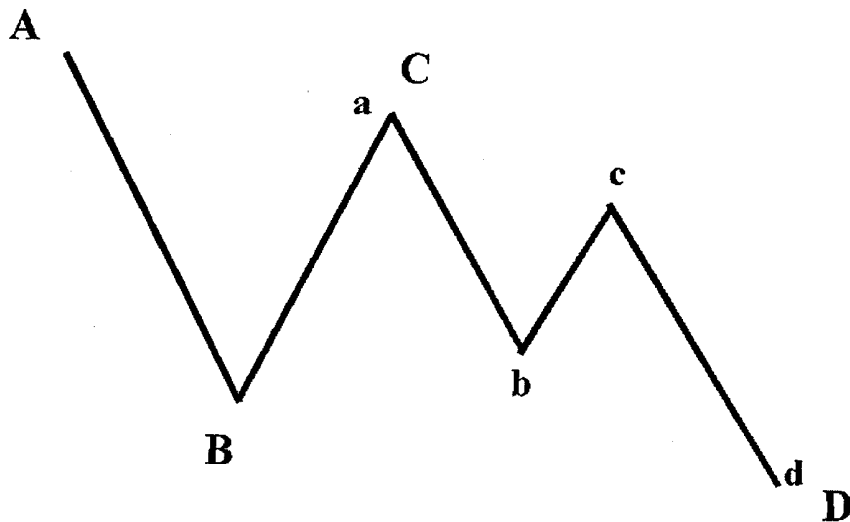

BULLISH AB=CD
MINOR ab=cd WITHIN MAJOR AB = CD

BUY AT POINT D!

When two AB=CD patterns converge at the same area, you must assume that a reversal is highly probable. If a stock forms a pattern like this illustration, the entry point will be practically obvious. Even if the potential

reversal zone, as defined by the completion points, does not yield a significant profit, the reversal usually will provide some type of a bounce.

It is amazing that price action can form such patterns. A stock often acts very unusually, as it enters an area where two AB=CD patterns complete. If the set-up is valid, the reversal can be sharp. However, if the trade is not a good opportunity, the price action usually will sell-off right through the potential reversal zone. Let's look at some examples.

Just For Feet sold off over a five month period in a very consistent fashion, forming a distinct AB=CD pattern with a smaller ab=cd pattern. The stock reversed within a point of both patterns. It reversed within a 1/4 point of the smaller ab=cd pattern as well.

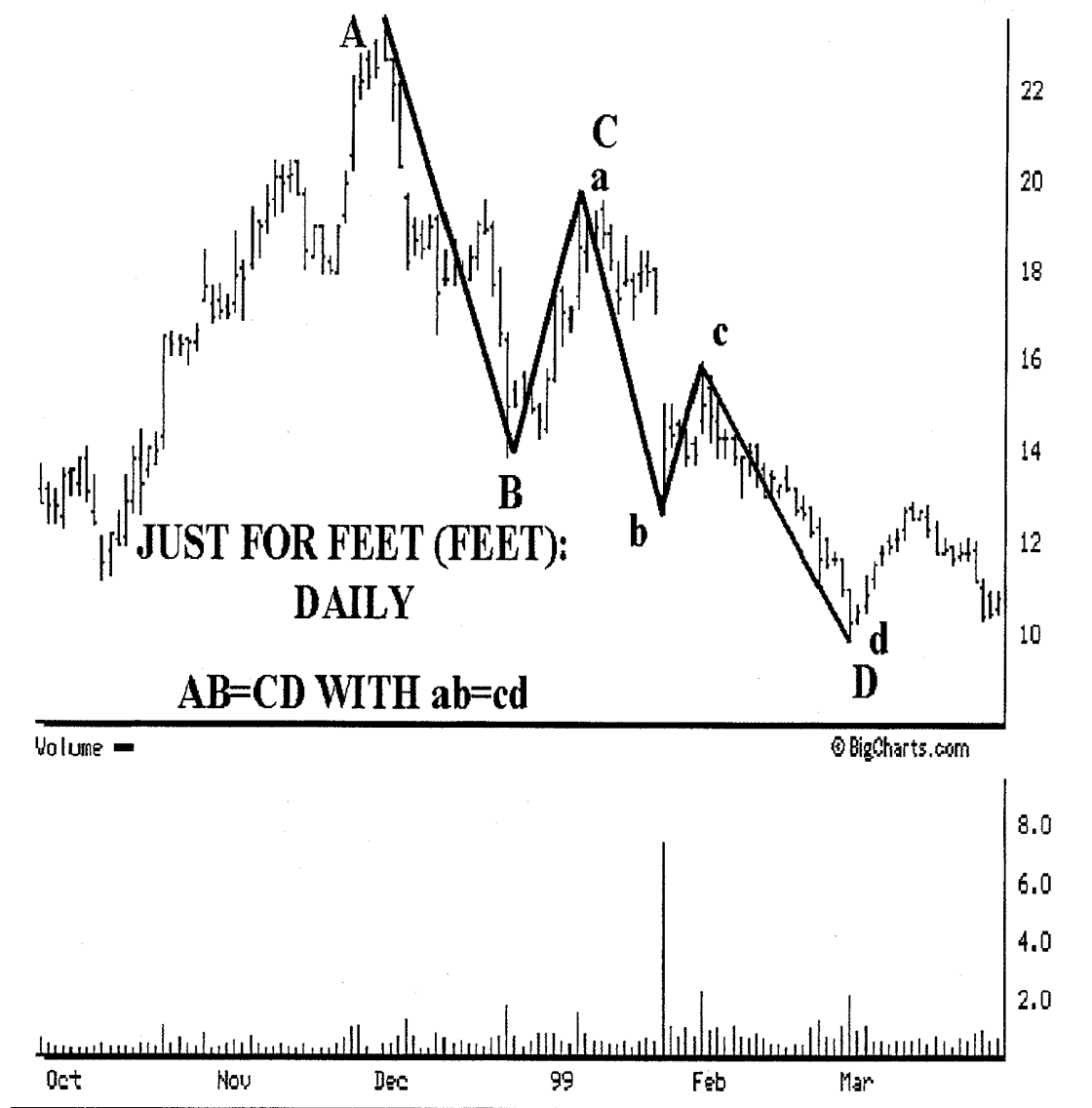

The stock reversed just below 10 and rallied over 25% during the next eight days. I think that is a pretty nice return for just being able to do some simple calculations. Seriously, the potential reversal zone, as defined by the AB=CD patterns, suggested that the stock could reverse somewhere between $9 \frac{3}{4}$ and $10 \frac{1}{2}$.

The trade required a small stop loss limit to see if this AB=CD, ab=cd convergence was a valid harmonic set-up. The stop loss limit might be $\frac{1}{2}$ of a point below the low end of the calculated zone – maybe $9 \frac{1}{4}$ or even $9 \frac{1}{8}$. Although this opportunity might seem too simplistic, AB=CD patterns like this occur frequently and can indicate good areas for successful trades.

I want to relate my own experience, as I bought the stock in the potential reversal zone. I saw this set-up coming together nicely. I calculated the major AB=CD at $10 \frac{1}{8}$ and the minor ab=cd at $9 \frac{15}{16}$. Originally, I entered my order to buy at $9 \frac{15}{16}$. But, before the stock sold off in this area, I removed my order.

The stock hit $9 \frac{13}{16}$ ths and started to rally. I didn't believe that the stock would reverse off this area. So, I missed out on an extra $\frac{1}{2}$ point but I still made some money. I eventually bought at $10 \frac{1}{4}$ and picked up 2 points in a week. I stayed in the trade until the stock formed a bearish price bar. Actually, I was not very impressed with the initial bounce. The patterns were so clear that I thought the reversal would yield a sharp bounce. But, the stock lacked any significant rally and I sold my position with a small profit.

The next chart clearly illustrates the pattern. Barrick Gold formed an amazing AB=CD with a smaller ab=cd. The potential reversal zone was defined quite nicely by the convergence of four harmonic numbers and two patterns – right around 13.

The larger AB=CD was projected to complete at $13 \frac{1}{2}$, while the smaller ab=cd was calculated to complete at $12 \frac{1}{2}$. The 1.27 projection of BC and the 2.24 projection of the smaller bc leg both were calculated at $12 \frac{7}{8}$. With so many harmonic projections converging in this area, the set-up was very clear – buy this stock around 13. The stock reversed after hitting $12 \frac{7}{8}$.

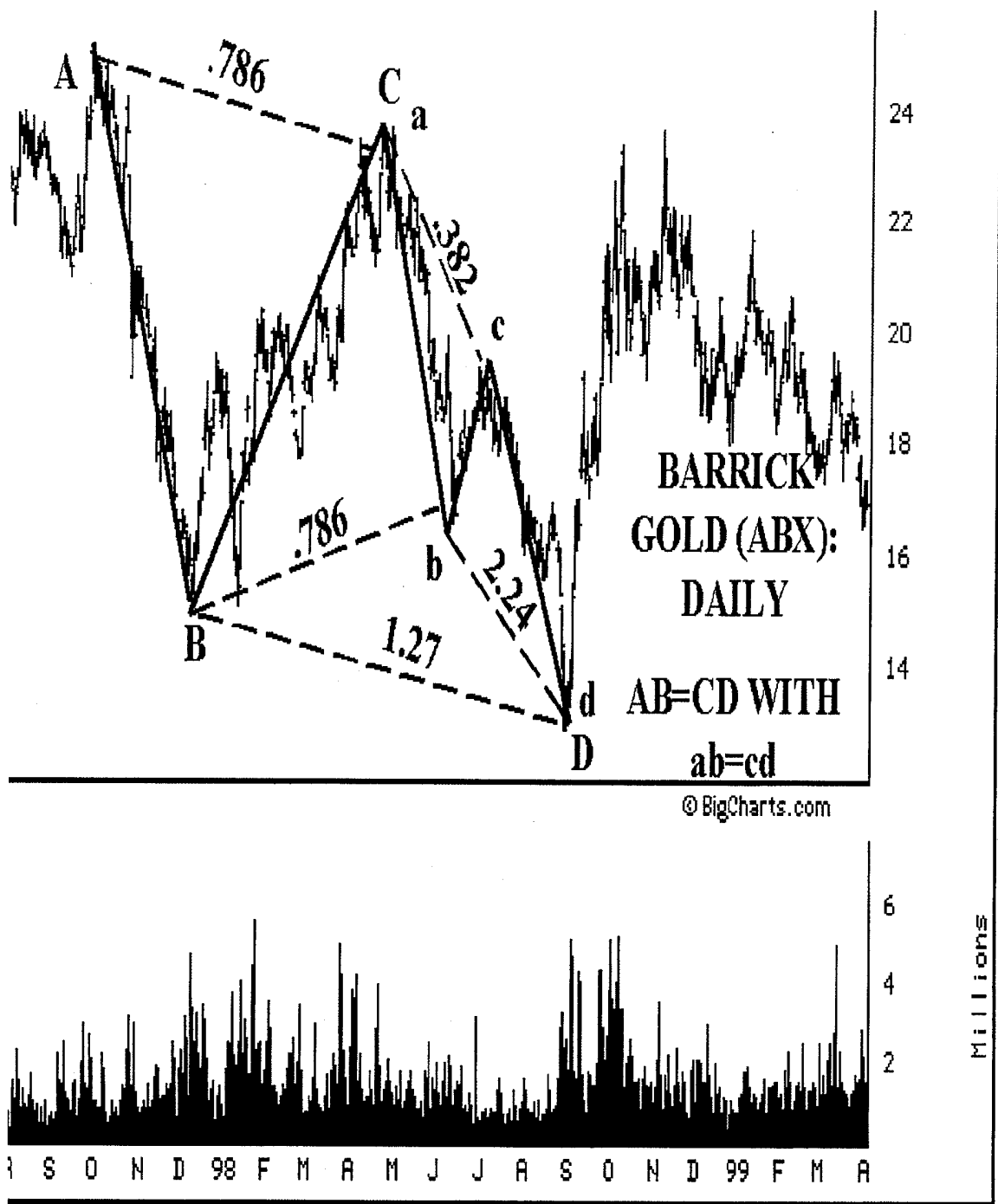

I can't emphasize enough the significance of set-ups like Barrick Gold. When four numbers converged within a point the probability for a reversal was very likely. Barrick Gold reversed sharply from this area, rallying over 75% in the next few months. It is an example like this one that truly exemplifies the harmonic qualities that stocks can possess.

Bearish AB=CD with ab=cd

The bearish AB=CD with a smaller ab=cd is also a clear indicator of a potential reversal. Stocks will frequently rally strongly but form a very distinct pattern that is exactly like the following illustration. It might be difficult to believe that stocks can form such price action – but they do!

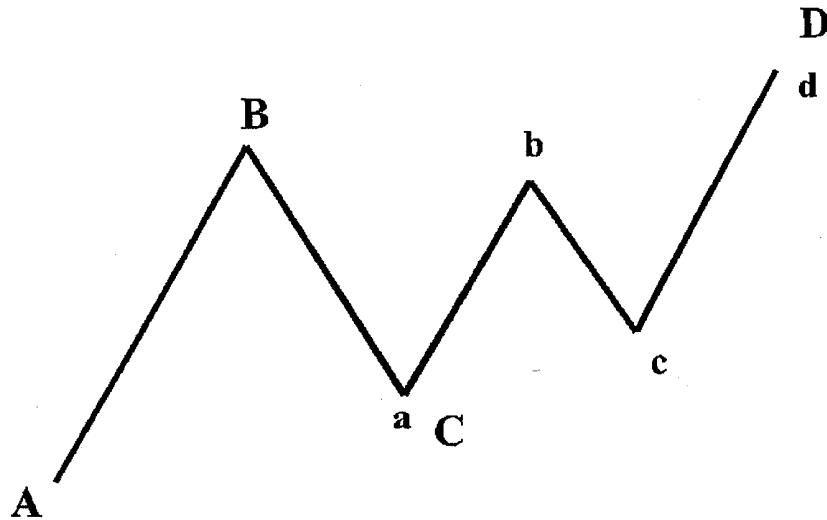

**BEARISH AB=CD
MINOR ab=cd WITHIN MAJOR AB = CD**

SELL AT POINT D!

Once you are able to identify such price action, this pattern will jump out at you. Also, the convergence of two AB=CD patterns will clearly indicate the potential reversal zone. The best way to illustrate this pattern is to show an example.

Apple Computer completed a nice AB=CD with another ab=cd. The major AB=CD reversed almost exactly at the projected completion point. The major AB leg was $18 \frac{1}{8}$ points, while the CD leg was $18 \frac{13}{16}$ points. This large pattern had a nice ab=cd pattern as well. Although this pattern was not exact, it was still harmonic. The smaller ab=cd pattern converged at projected completion point for the AB=CD, but it required an alternate calculation. The ab leg was $12 \frac{13}{16}$ points, while the cd leg was $16 \frac{5}{16}$ points. The reversal occurred exactly at the 1.27 of the ab leg at $47 \frac{5}{16}$!

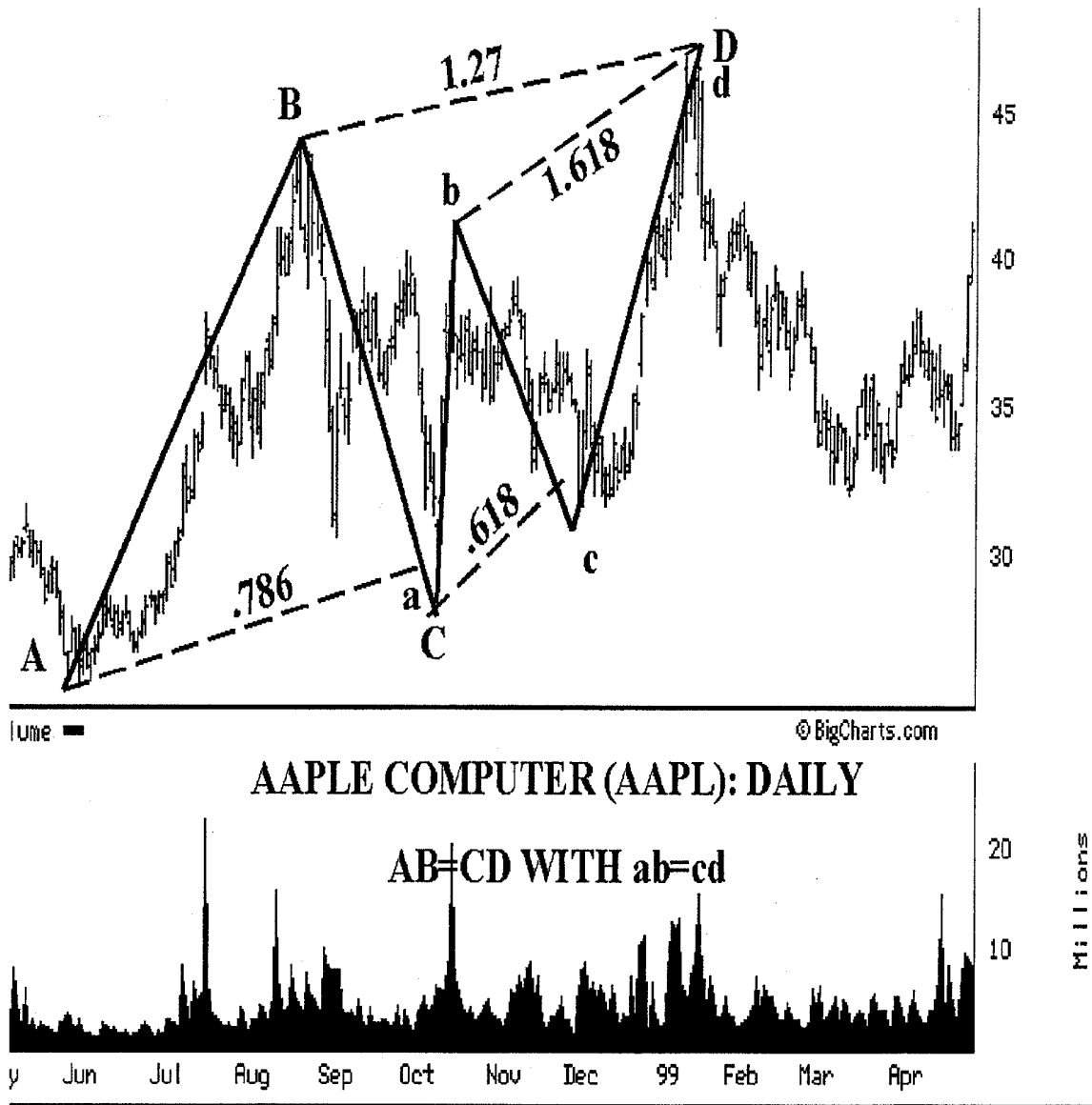

When two $AB=CD$ patterns converge, the probability for a reversal is very likely. Although the smaller pattern required an alternate calculation, the harmonic projections still indicated that Apple was a potential sell around 47.

This set-up was harmonic because the two $AB=CD$ patterns were distinct and generally symmetrical. Although I consider the larger $AB=CD$ to be a more significant harmonic number, the smaller $ab=cd$ complemented the set-up very well. It is important to recognize these situations; as such a convergence of patterns will indicate great opportunities for potential reversals. In this case, Apple sold off sharply in the weeks following the reversal.

The next chart of Wells Fargo is absolutely phenomenal! The stock has two $ab=cd$ patterns within the large $AB=CD$. As you can clearly see, this daily chart has several distinct $AB=CD$ patterns that are all closely equivalent.

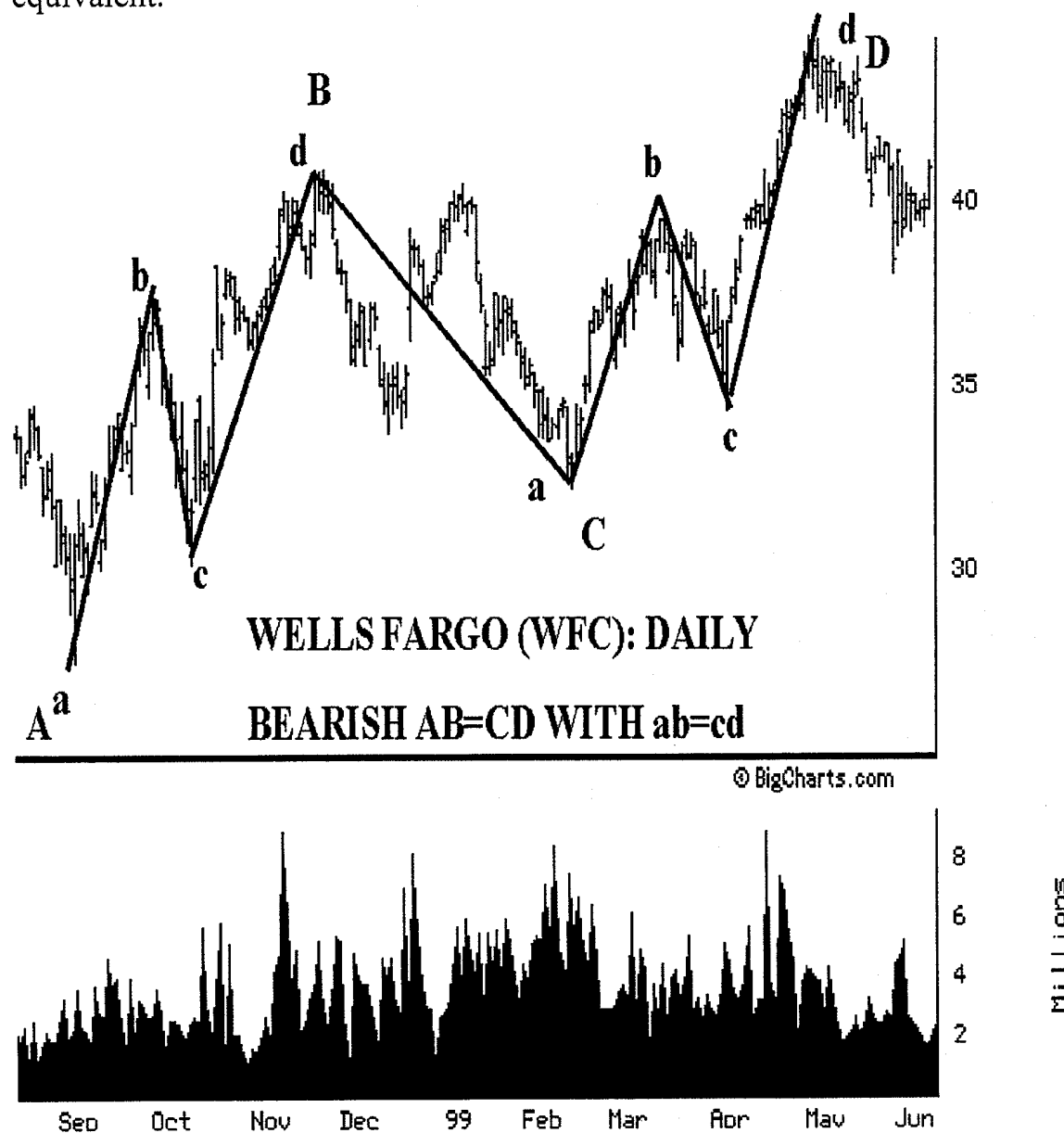

This is another beautiful chart to study. Almost every price move generally adheres to the $AB=CD$ pattern with distinct rallies and declines. The price legs of the larger $AB=CD$ pattern are approximately 13 points. The smaller legs, although not as equivalent as the larger pattern, are roughly 9 points. These projections indicated a selling opportunity in the low to mid-40s. The stock reversed just shy of 45 at $44 \frac{7}{8}$.

This chart is a good example to study because the AB=CD patterns have nice symmetry. The price legs are generally close in duration. Each leg of the large AB=CD was approximately three months, while the legs of the smaller ab=cd were slightly more than a month.

When these patterns form repetitively and are this distinct, they provide fantastic set-ups. In my opinion, the larger AB=CD is a more significant pattern than the smaller ab=cd. But, it is very common for a reversal to occur at the completion point of the smaller ab=cd pattern. So, I recommend that you study the entire harmonic area, realizing the potential for a significant reversal.

AB=CD Summary

On a final note about the AB=CD, as I have said before, it took me a long time to think in an AB=CD framework. I knew that the pattern worked, yet time and time again I jumped in long before an AB=CD was complete, fearing that I would "miss out" on huge profits because "I knew" that I was going to make money. It was not until I lost enough money that I literally had to train myself to execute within the AB=CD framework.

One reason that it took me a long time to respect the AB=CD is that it seemed too simplistic. I wondered: how could stocks trade in such a fashion? I do not have an answer for why the AB=CD is a valid signal, other than I have witnessed hundreds, if not thousands, of charts that have reversed after completing the pattern.

I believe that this is the most important pattern in this book. If you can master one trading technique from this book, it must be the AB=CD pattern. I have not only made this pattern a rule, but it's one of my fundamental trading "laws." I am serious! This simple framework will make you a very successful trader.

The pattern seems very basic but it can be very difficult to execute properly. When you initially utilize this pattern, it is important to write the pattern on the stock chart that you want to trade. For example, if you want to sell, write the pattern on the chart and draw an arrow exactly at point D. Next to the arrow, write: "Sell at D!" It is important to do such reinforcement exercises to train yourself to execute correctly because this framework will truly make you "buy low and sell high."

14

Gartley 222

The Gartley 222 is a very powerful, multi-dimensional pattern. It is called a Gartley 222 because it is found in H.M. Gartley's book, Profits in the Stock Market, on page 222. I will simply refer to this pattern as the "Gartley."

The important features of the Gartley are the specific location of the various points: X,A,B,C and D. The X-A leg is the largest price move in the pattern. It is followed by a counter move of A to B. The first leg, A to B, sets up the potential $AB=CD$, which is crucial to the completion of the pattern and to the indication of the reversal zone. After a brief and smaller B to C retracement, the C to D leg is established. A precise calculation of the $AB=CD$ will provide a significant potential reversal point.

Ideal Gartley

The ideal Gartley set-up will be defined by specific Fibonacci retracements. One of the most important numbers in the pattern is the completion of point D at the .786 of XA. Although the price action might exceed this number slightly, it should not exceed point X. The pattern is a nice set-up, especially with the convergence of an $AB=CD$.

Another important point in the pattern is the .618 retracement of the XA leg. The AB leg should reverse very close to this retracement. The .618 retracement at point B is critical because it will establish another Fibonacci projection - usually a 1.27 of BC - in the potential reversal zone at point D.

Bullish Gartley

In the bullish Gartley, it is important to note that certain points in the pattern must be located properly to ensure a valid signal.

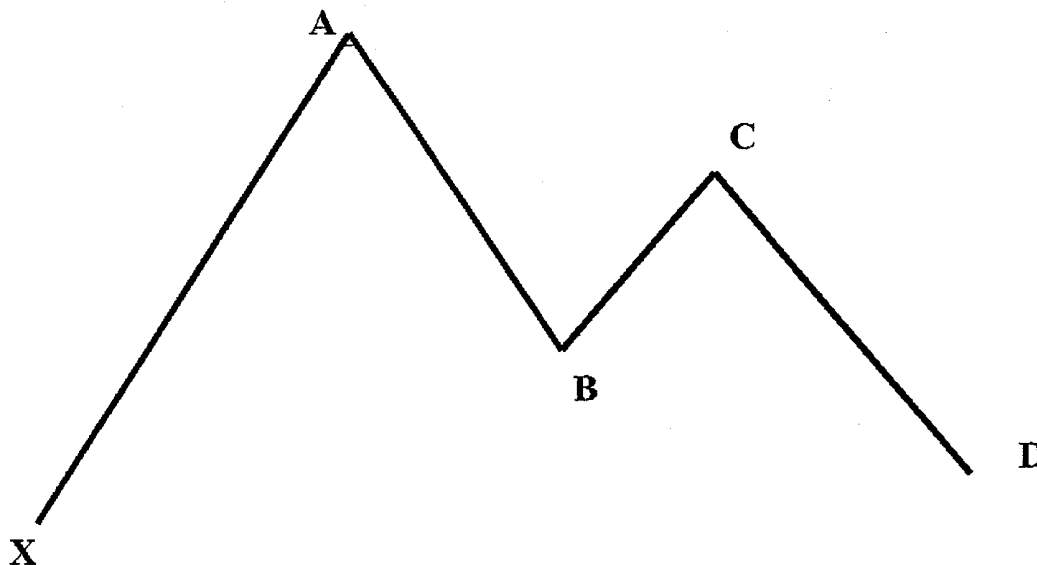

**BULLISH GARTLEY
BUY AT POINT D!**

Point X is below all of the points in the pattern. Point A must be above point C, and point D must complete below point B. The most critical aspect for a valid reversal is that point D must hold above point X. Furthermore, the pattern should possess a clear $AB=CD$ pattern.

Bullish Gartley Stop Loss

The key to any trade execution is determining in advance the amount you are willing to risk. Defining the “uncle point,” or stop loss limit, is crucial in containing losses and preserving equity capital. A stop loss limit in harmonic trade set-ups is really the point at which you believe the potential reversal zone is no longer valid. Harmonic trade set-ups are effective because they define a high probability area for trend reversal. Once that area is defined, the point at which the set up is no longer valid is fairly clear.

The stop loss limit in this pattern is measured relative to the initial point (X) of the defined pattern. In a bullish Gartley, the stop loss should be placed just below the initial point (X).

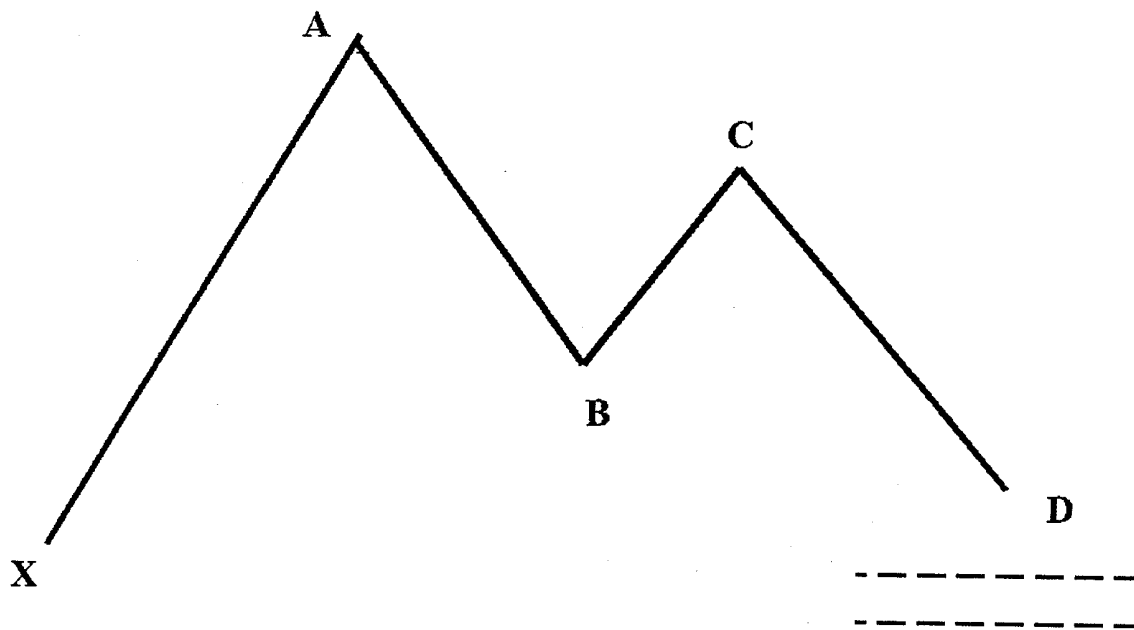

BULLISH GARTLEY: STOP LOSS JUST BELOW POINT X!

Although the price action can retest the extreme point at X, the stock must reverse above this key area for the pattern to be valid. So, it is very important to examine the price bars in this area and be wary of any potential warning signs that might invalidate the pattern.

Ideal Bullish Gartley

The ideal bullish Gartley has specific Fibonacci retracements that are essential to define a valid pattern. In my opinion, the .786 is the most important number in the potential reversal zone. Although there are several other harmonic calculations that define the potential reversal zone, I believe the .786 is the most important number in the pattern because it is a projection off the largest price leg.

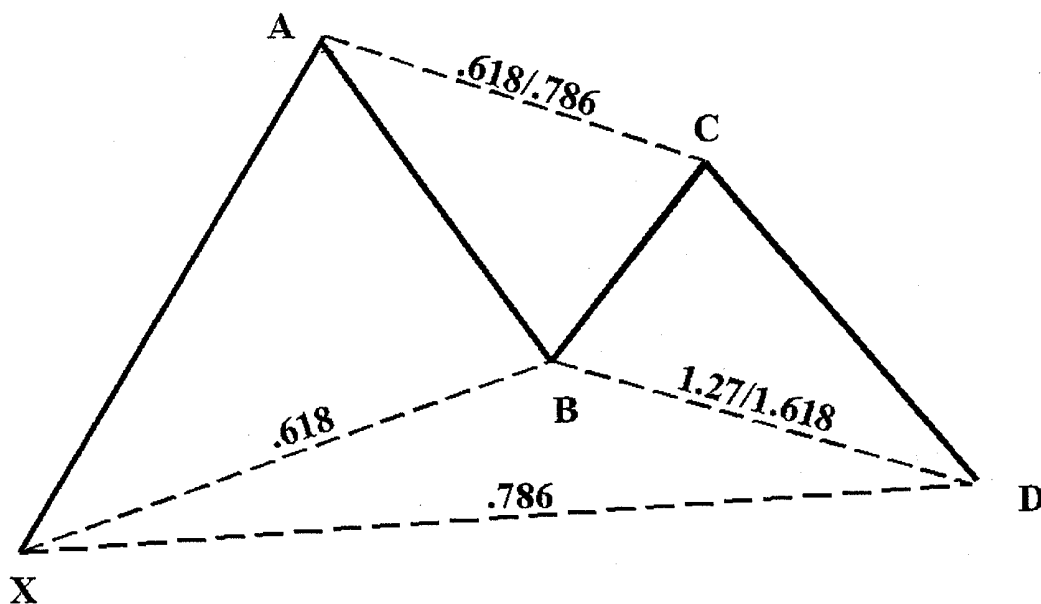

**IDEAL BULLISH GARTLEY
BUY AT POINT D!**

Another very important harmonic calculation is the completion point of the $AB=CD$. I consider this entry point to be a minimum requirement for a trade to be executed. The $AB=CD$ completion point is useful because it should nicely complement the area of the .786 of the XA leg. Let's look at some examples of ideal bullish Gartley patterns.

Wells Fargo formed this bullish Gartley that was extremely harmonic. There were several numbers converging within less than a point and a half – between 31 15/16 and 33 5/16.

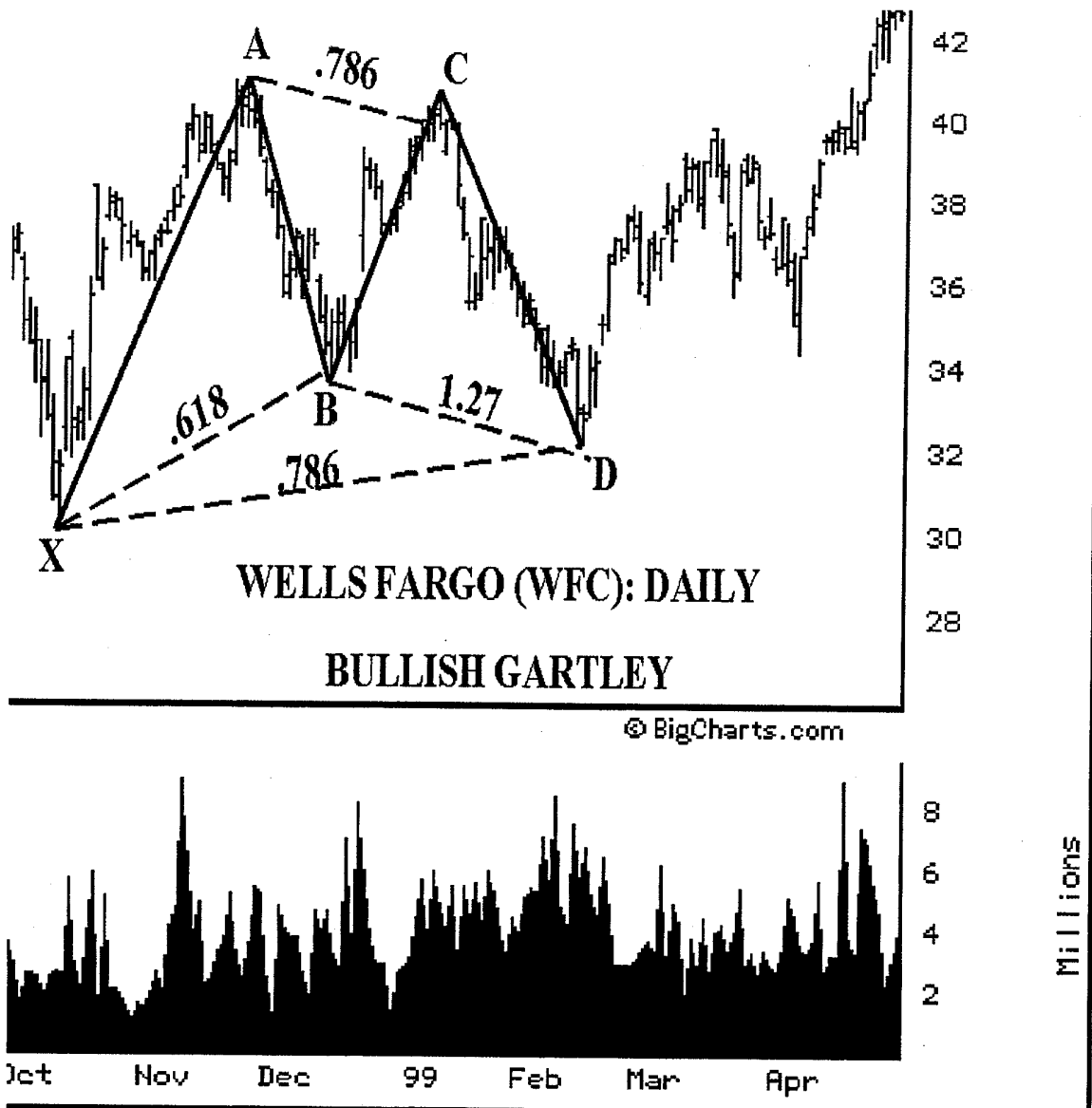

There were three harmonic calculations that clearly defined the potential reversal zone. The stock possessed a nice $AB=CD$ pattern. Although the CD leg was slightly extended, the distance of the two legs was relatively close. The AB leg was $7 \frac{1}{8}$ points, while the CD leg was $8 \frac{5}{16}$. The completion point of $AB=CD$ was projected at $33 \frac{5}{16}$. The .786 retracement of XA was calculated at $32 \frac{1}{8}$. The 1.27 projection of BC was located just below 32 at $31 \frac{15}{16}$.

The following enlarged chart illustrates the price action in the potential reversal zone very well. As you can see, the stock literally bounced off this area. Although the price action was somewhat strong on the day it hit the potential reversal zone, the stock turned around quickly in the next few days.

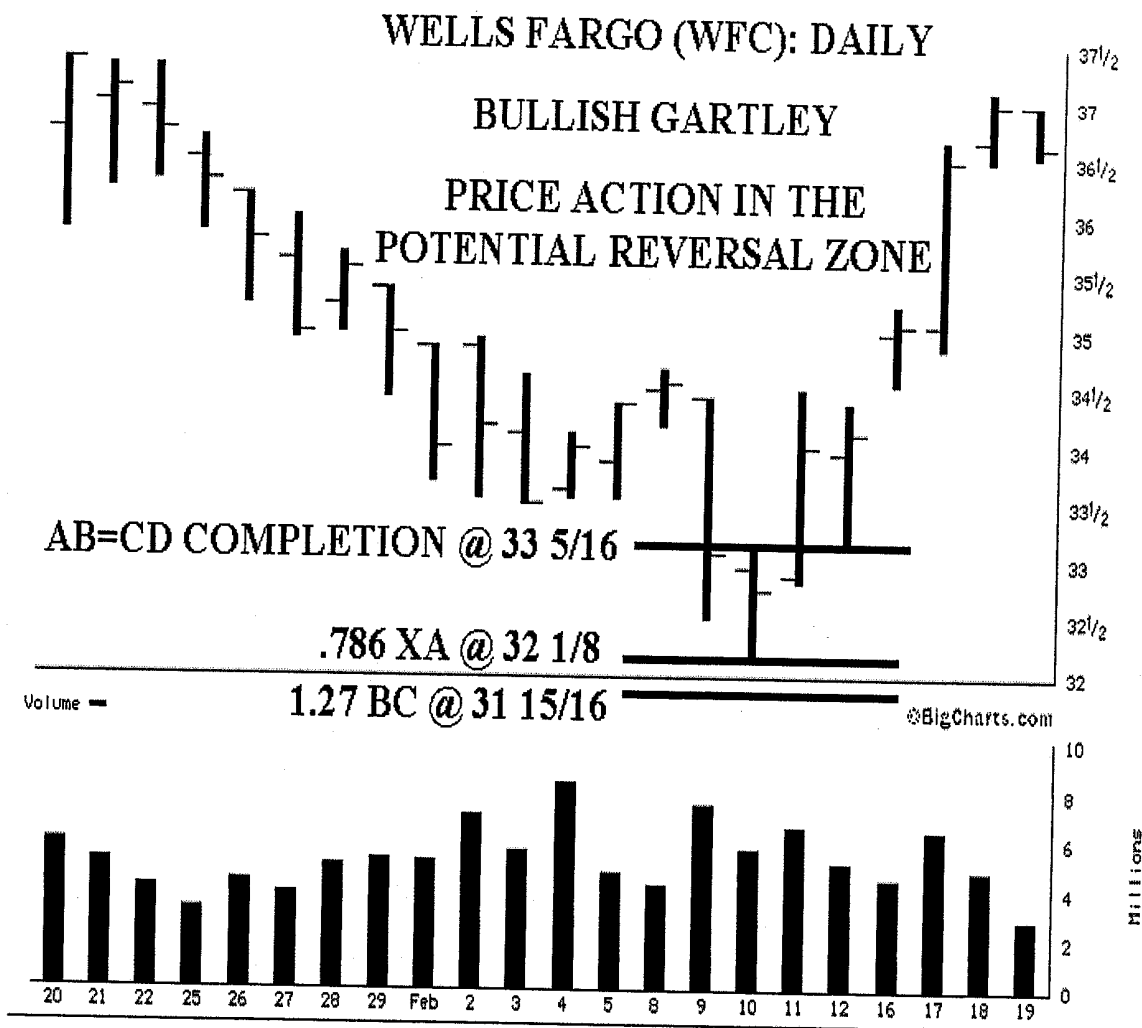

When three numbers converge in a specific area like this example, the probability for a reversal is very likely. Wells Fargo reversed exactly off the .786 retracement of the XA leg at 32 1/8. The stock rallied over 10 points in two months - equivalent to over a 30% gain.

Legato Systems is another great example of a stock that formed a very nice geometric pattern and yielded quite a reversal. Although the final leg of the pattern became a bit extended, the stock reversed within an unusually large reversal zone that possessed several harmonic numbers within a few points of each other.

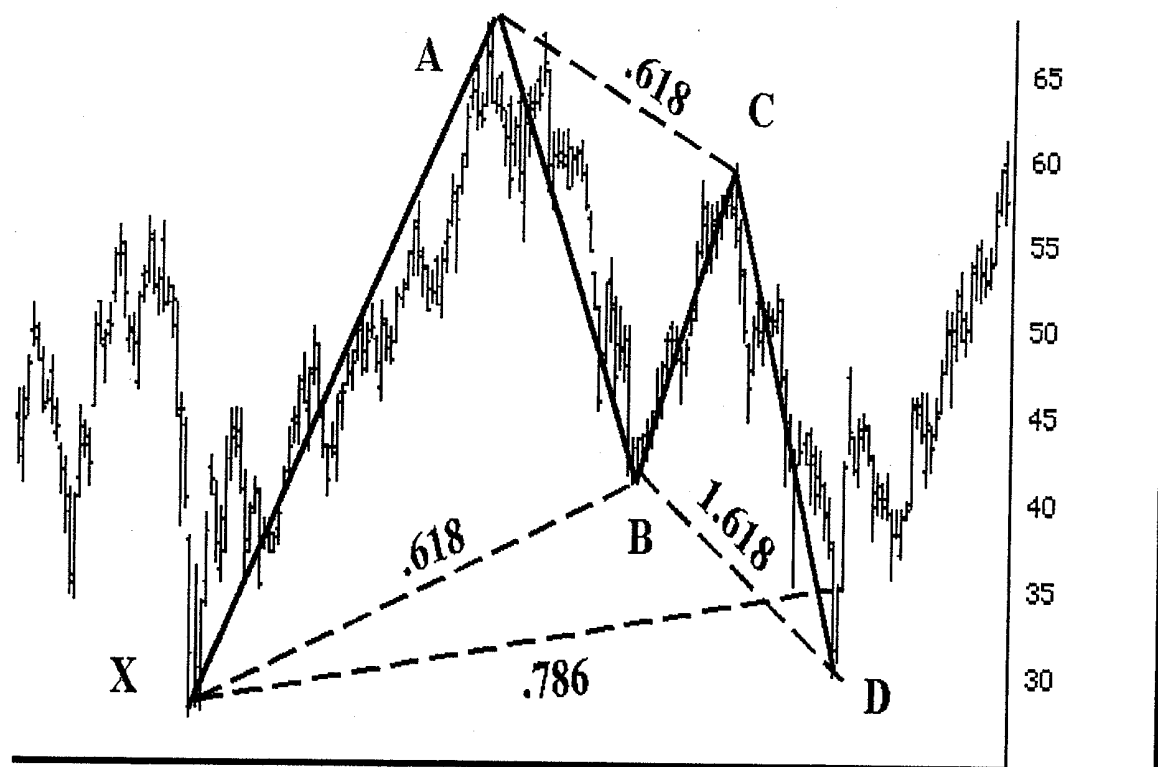

© BigCharts.com

LEGATO SYSTEMS (LGTO): DAILY

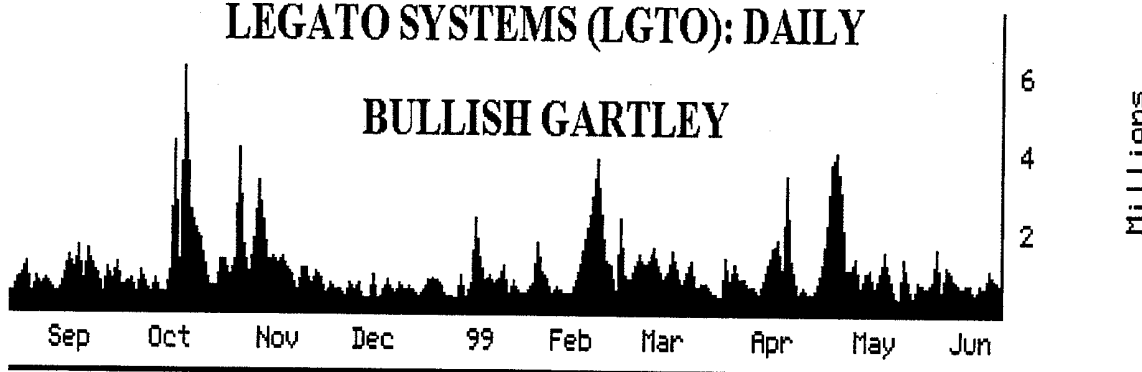

The most important number in the pattern was the .786 retracement of the XA leg, calculated at $36 \frac{1}{8}$. The stock exceeded this number by quite a bit. But, the exact $AB=CD$ was projected to complete at $32 \frac{7}{8}$. I like to wait for the exact $AB=CD$ to complete within the potential reversal zone before executing a trade. So, I would have waited until the stock sold off to this point before buying. In addition, the stock was exhibiting some extreme price action, so the most prudent action would have been to wait a day to gauge the price action.

The interesting aspect of this trade is that the stock sold off through almost the entire potential reversal zone on the day it hit the area. In fact, on

this day, the stock was down 7 points. The stock opened at 37 3/4, and sold off rapidly throughout the day, closing at 30 1/2. Such extreme price action would indicate that the set-up should be watched closely and wait for clear reversal confirmation.

I have included an hourly chart of that day. As you can see, when Legato hit the first number in the potential reversal zone – the .786 of XA at 36 1/8, the price action was quite strong. The stock continued down most of the day. In fact, the stock did not break above the prior hour's high, and Legato continued to make lower lows throughout the entire day.

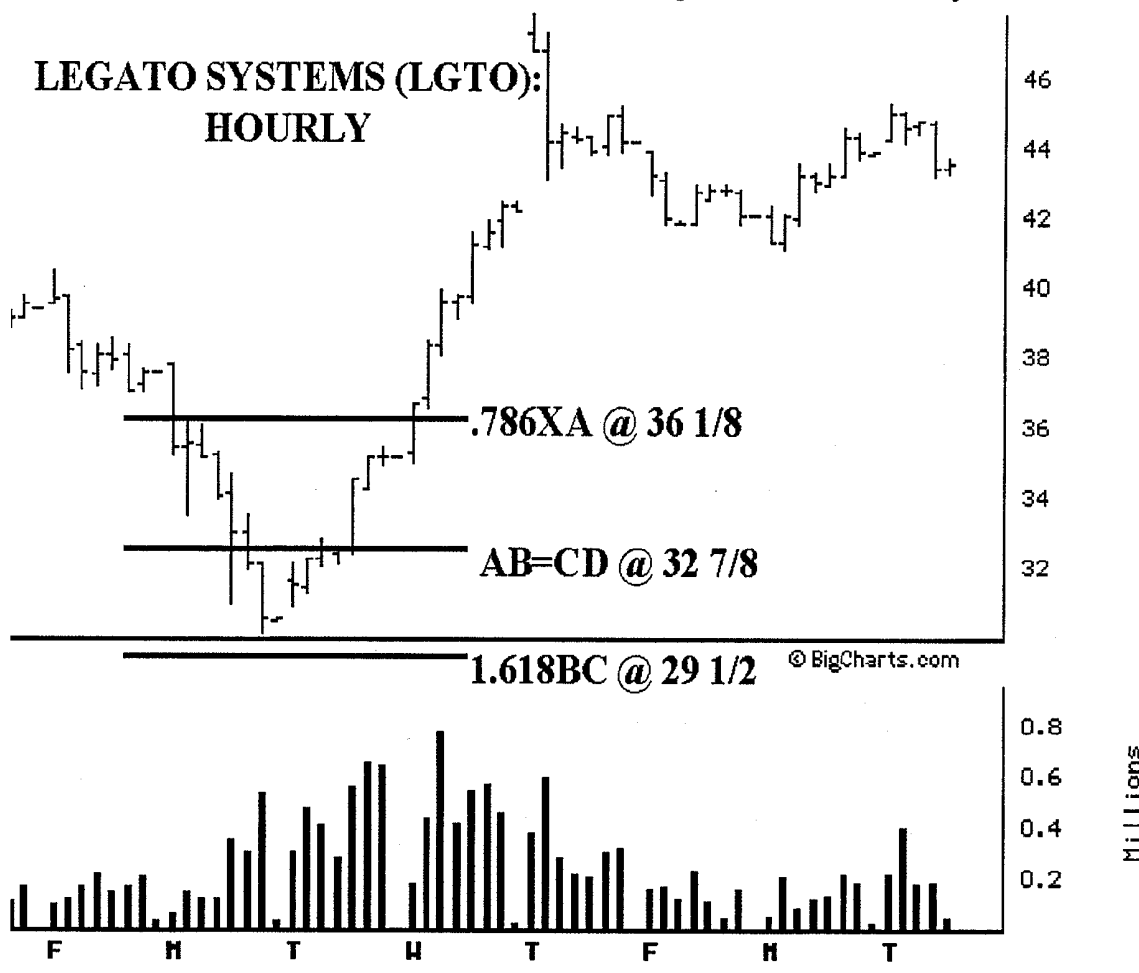

In this situation, you probably should wait a day and follow the stock closely. The stock finished the day near the low, which also would have warned of potential reversal failure. However, the next day the stock gapped up on the open and continued higher. You could have waited a few hours for the stock to confirm the new uptrend and still have been buying very close to a substantial bottom.

This example of Legato illustrates the importance of respecting the warning signs – a price gap, a tail close, or an extreme price range. When you wait one price bar, in this case the next day, the price action will indicate whether or not a reversal will occur. If the stock is going to reverse, you want to see bullish price action that breaks the prior day's high. Ideally, the price action should close above the prior day's high, although any type of bullish close is a good sign.

It is important to note that in this example of Legato, the stock did not continue to sell off the day after the extreme price action entered the reversal zone. This is especially significant because on the day it sold off, the stock closed near the low of the day. With such an extreme day down and such a bearish close, you would probably assume that the stock would be heading lower. But, the next morning Legato did not continue to decline. It reversed and rallied 18 points in the following three days.

This chart example shows how Sportsline.com, an Internet company, formed a terrific bullish Gartley on this hourly chart.

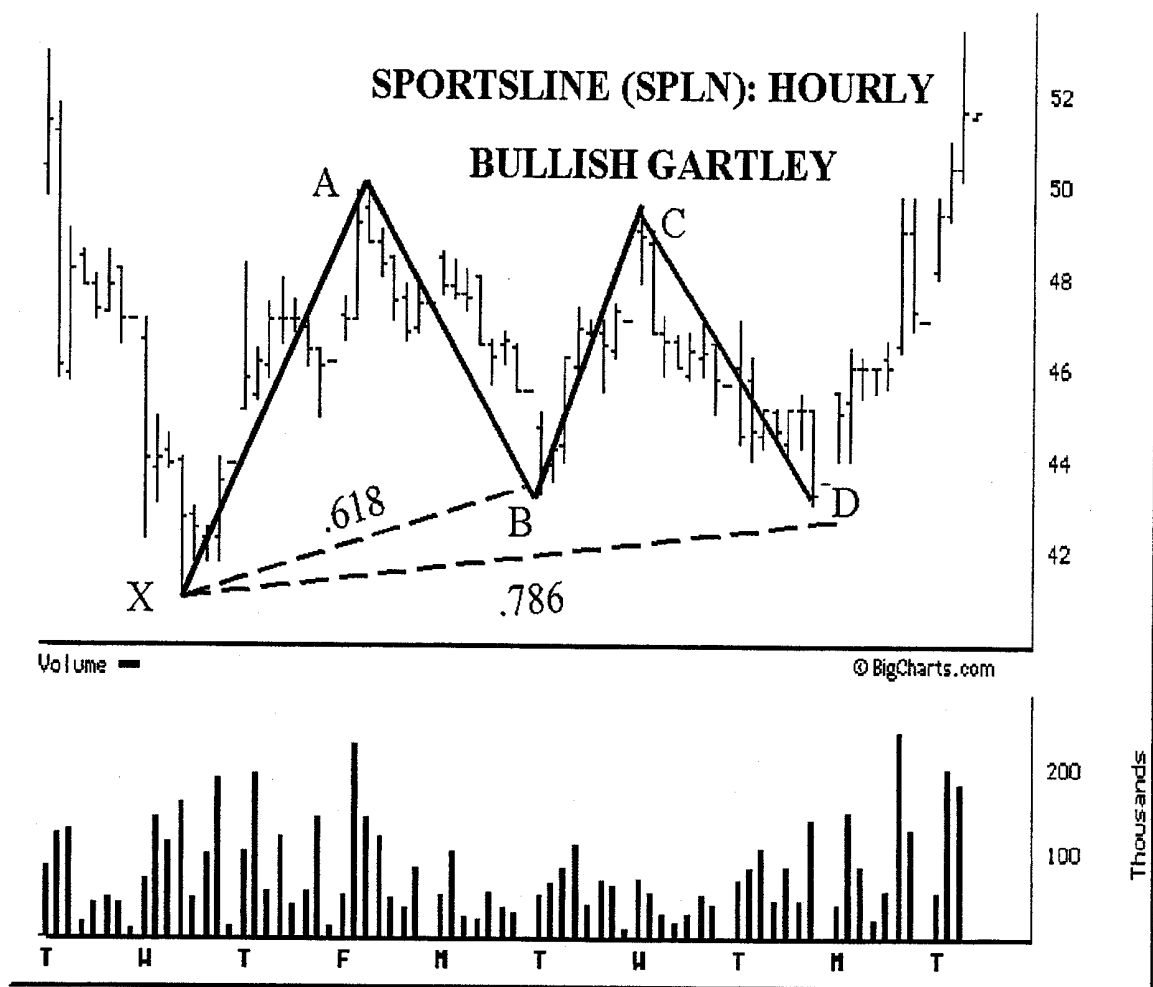

One of the reasons I included this chart was because I wanted to relate my personal experience with this set-up. Although the stock did not hit the .786, it did reverse right off the AB=CD. The .786 retracement of XA was around 42 1/2. The AB=CD completed just above 43. The stock hit 43 1/8 and rallied over 10 points in the next two days!

I saw this pattern develop but I was waiting for the .786. The stock never hit it and I missed the move. This is a situation where I had to just let it go. It was a great opportunity but it did not reach my price objective – the .786. Although I was not happy about missing out on the 10 points, I know that there will be even better set-ups in the future!

I saved the next example for last because it is such a harmonic chart. On this weekly chart, Chiron bounced off a potential reversal zone that included five harmonic calculations!

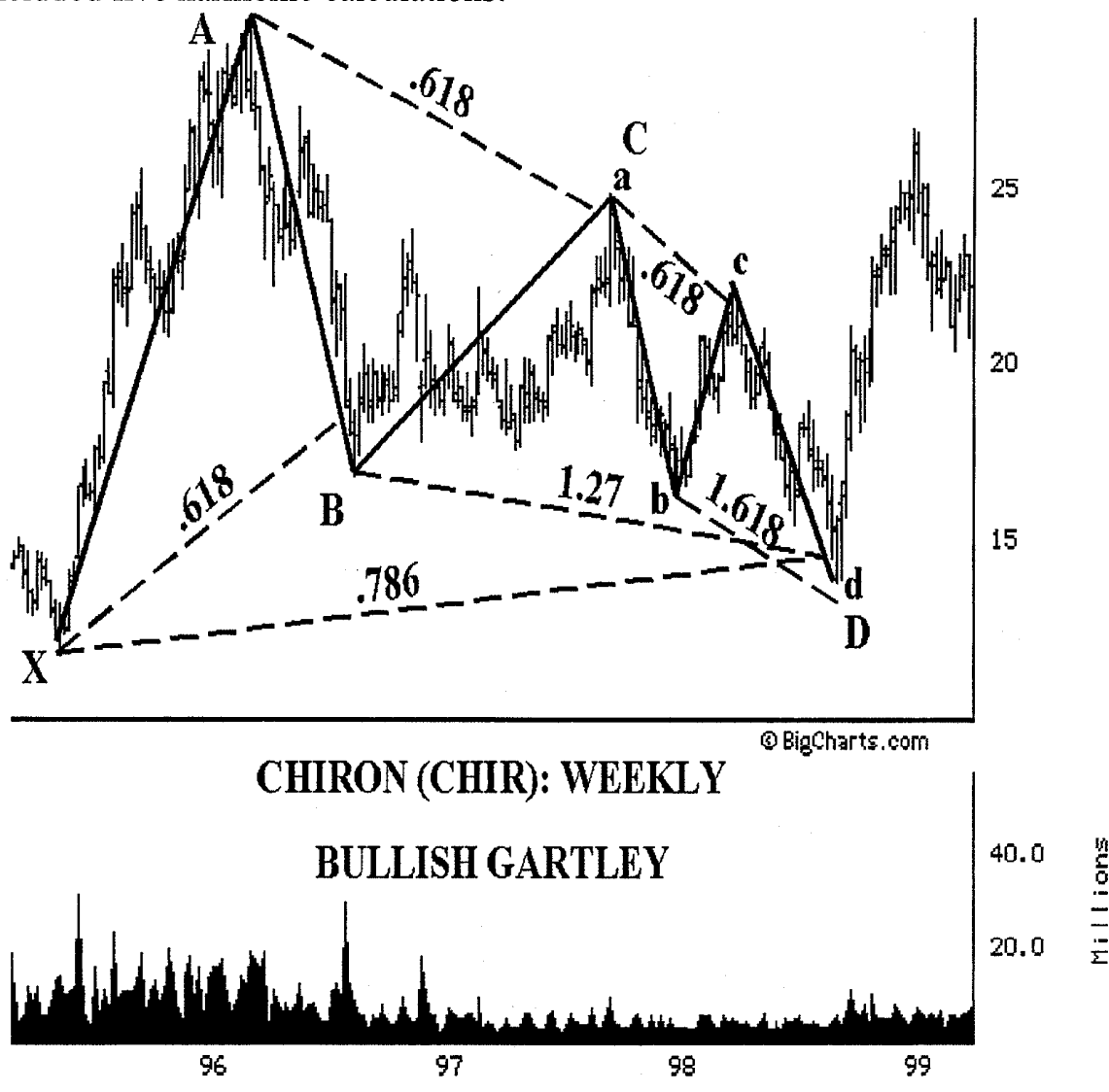

The potential reversal zone converged in an area that was about 3 3/4 points, between 12 1/8 and 14 9/16. The most critical number, the .786 of XA was calculated at 15 3/4. However, there were several other numbers that converged below this area. Another number that complemented the .786 was the 1.27 of the BC leg at 14 9/16.

One of the most harmonic elements of this set-up was the completion of a smaller ab=cd within a larger AB=CD. The larger AB=CD was projected to complete at 12 1/8, while the smaller ab=cd was calculated at 13 13/16. Both of these patterns were projected to complete very close to each other. Also, the 1.618 of the bc leg complemented this area at 13 1/4. When two AB=CD patterns converge this close together, you must consider that a reversal is highly probable. In this case, Chiron reversed almost exactly after completing the smaller ab=cd.

**CHIRON (CHIR): WEEKLY
BULLISH GARTLEY
PRICE ACTION IN THE
POTENTIAL REVERSAL ZONE**

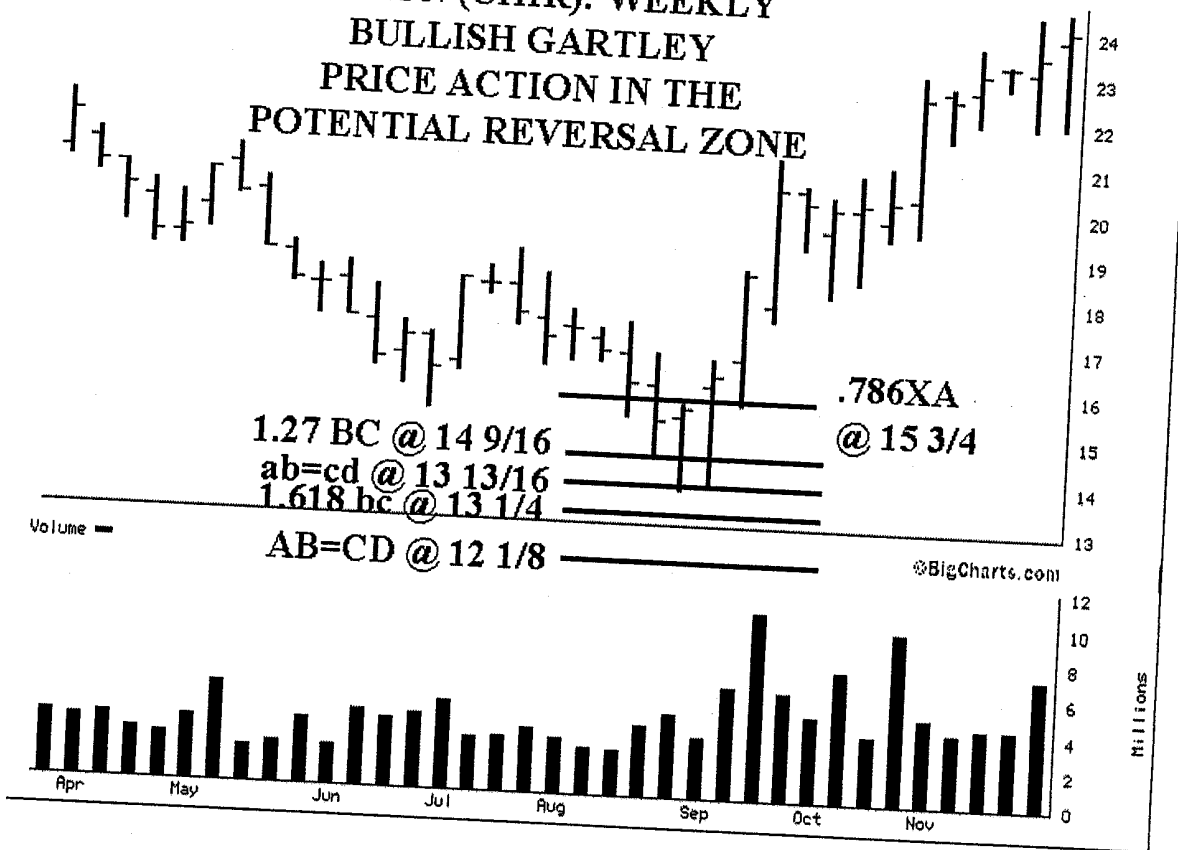

I have included this enlarged chart of the set-up. As you can see, the stock bounced sharply after hitting this area. The reversal was confirmed by the strong breakout that occurred a few days after the stock hit the potential reversal zone. This area yielded a significant bounce, as the stock rallied almost 100% within three months.

This was a fantastic set-up because your loss limit was very clear. Your stop loss would have been placed just below X – maybe at $11 \frac{1}{2}$ or $11 \frac{1}{4}$. If the stock declined past this point, you would know that the reversal zone was invalid. However, with such a harmonic set-up the probability for a valid reversal was very likely. This example is another case where the risk was rather small in comparison to the potential bounce.

When this situation occurs again in the future, where five numbers converge in a specific area, you must realize that a reversal is almost certain. Although anything can happen in the stock market, this trade was an excellent opportunity to buy. After calculating the potential reversal zone, between $12 \frac{1}{8}$ and $15 \frac{3}{4}$, you should have known that the stock had to reverse within this area. Therefore, it is important to respect what the harmonic calculations are indicating because these set-ups can offer a substantial opportunity for profit.

Bearish Gartley

In a bearish Gartley, point X is the highest in the pattern. Point A must be below point C, and point D must complete above point B. Again, the completion of point D is critical for a valid reversal, as the stock must not rally above point X. The pattern is illustrated in the following diagram.

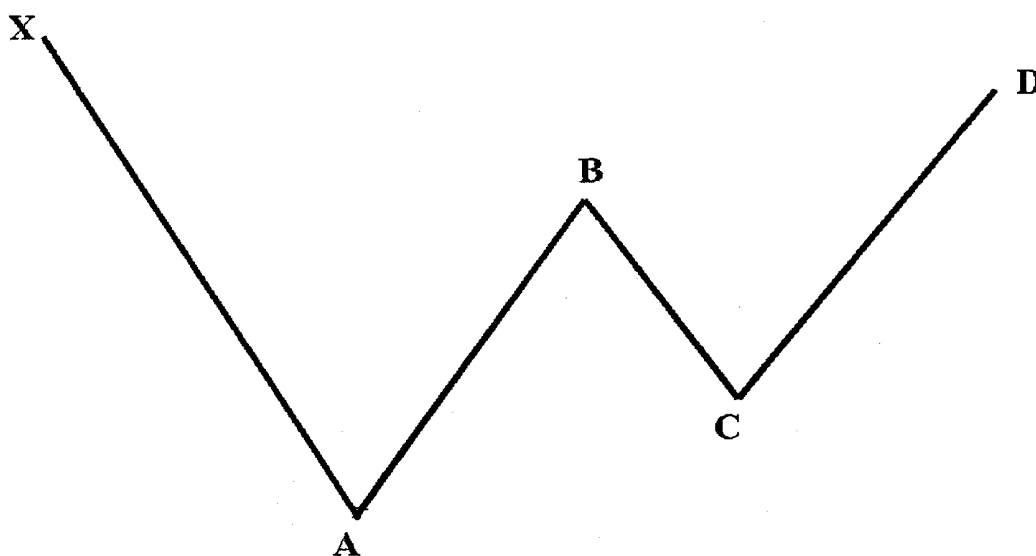

BEARISH GARTLEY:

SELL AT D!

These illustrations are the geometric patterns to look for in price charts for a valid Gartley. These patterns should be easily identified. If the pattern is not obvious, you might be trying to "force" the pattern. The key element in the Gartley is to look for a distinct $AB=CD$ set-up. Most Gartley patterns will have nice $AB=CD$ patterns that are very symmetrical, as well. These patterns occur frequently, so you should be able to observe them in many stock charts.

Bearish Gartley Stop Loss

In the bearish Gartley, the stop loss should be placed just above the initial starting point (X). Although price action can become extended and retest this area, the stock should not break above it.

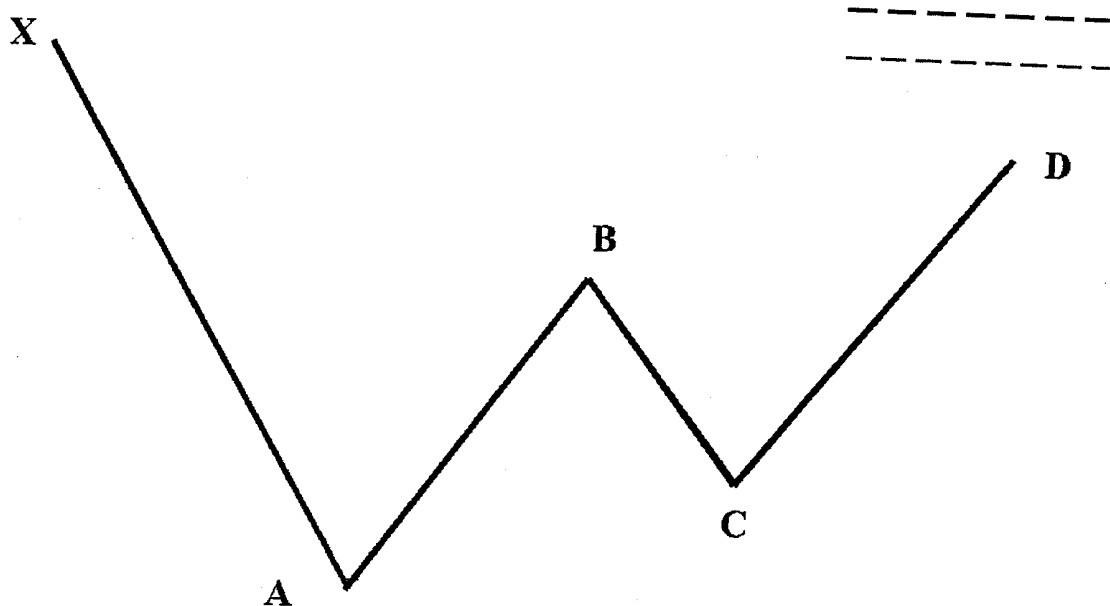

BEARISH GARTLEY STOP LOSS LIMIT JUST ABOVE X!

Sometimes, the price action will break the point at X and then reverse off that move. But, these situations are difficult to gauge. Personally, I focus on the price action in the area between points X and D. I want to see a clear reversal that occurs quickly.

I recommend that you closely watch the price action when a stock enters into the potential reversal zone. As with any trade execution, you should use caution and be prepared for anything to happen during such circumstances. But, the most important point in the stop loss limit for a Gartley is at X. If a stock breaks this level, the pattern is most likely invalid and will not yield the anticipated reversal.

Ideal Bearish Gartley

The ideal bearish Gartley has specific Fibonacci numbers that define the pattern. Again, the .786 retracement of the XA is the most important number in the potential reversal zone. The BC projection of either 1.27 or 1.618 should converge in the same area as the other two important numbers. A bearish Gartley occurs frequently and should be considered a significant reversal pattern.

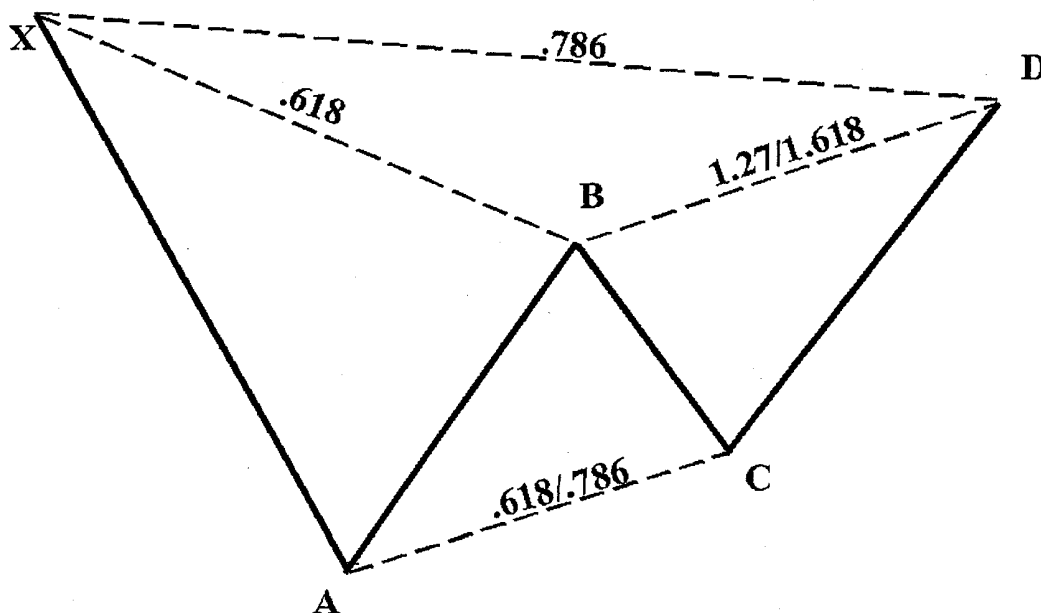

IDEAL BEARISH GARTLEY:

SELL AT D!

The beauty of this pattern is that several numbers converge at the .786. Also, the completion of the $AB=CD$ will clarify the set-up and help determine the execution point.

Often, the price action will act unusually, as it enters the potential reversal zone – either clearly reversing or blowing out the area. It has been my experience that if a bearish Gartley is not going to yield a reversal, the price action will rally strongly through the potential reversal zone. Let's look at some examples.

The first example of Hilton Hotels truly illustrates the framework of the pattern. The stock formed a very clear pattern that reversed significantly.

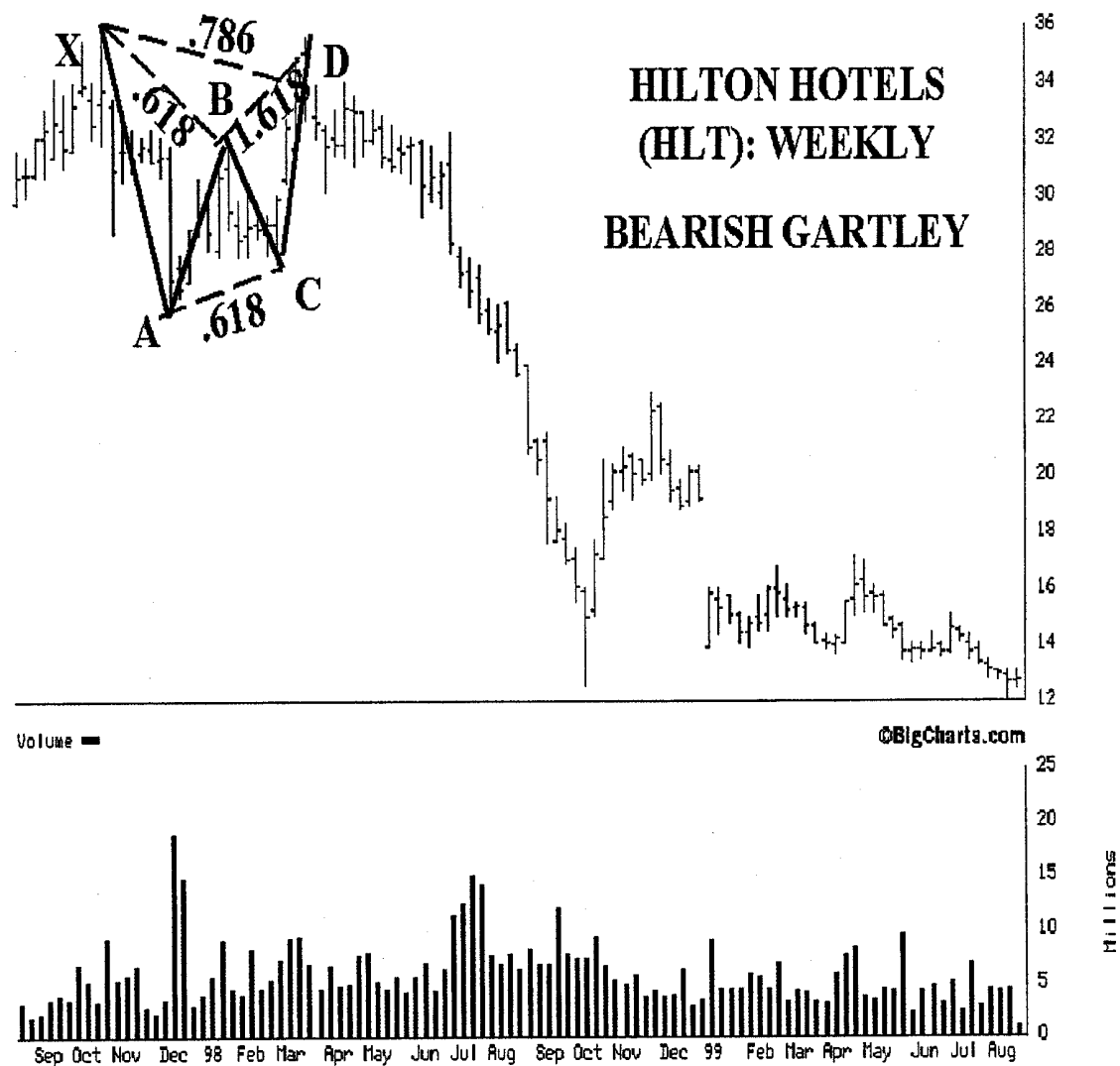

The potential reversal zone contained three harmonic calculations that indicated a selling opportunity right around \$34 a share. The most critical number, the .786 of the XA leg was calculated at 33 3/4. This area was

complemented by the 1.618 projection of BC, which was at 34 9/16. The AB=CD was below this area, since it was projected at 33 5/16. Although this is fairly close to the .786 of XA, the alternate 1.27 AB=CD was a better number for this set-up because it completed at 34 7/8, and it was much closer to the 1.618 of BC. Although it was somewhat unclear which AB=CD projection to use, the pattern clearly was indicating that the stock should be sold around 34. Hilton exceeded this area slightly, as it reversed at 35 1/2.

This situation underscores the importance of a proper stop loss limit. If the stock rallied above point X, somewhere above 36, the pattern would have been invalid. So, in this set-up, you would have risked approximately two points in exchange for a potentially powerful reversal. The stock plummeted, and it lost nearly two-thirds of its total value in six months!

I've included this enlarged chart to show the clear pattern that developed. It is amazing that such a nice pattern can materialize over a nine-month period. This weekly chart is a great example to study because it illustrates the framework of the pattern incredibly well.

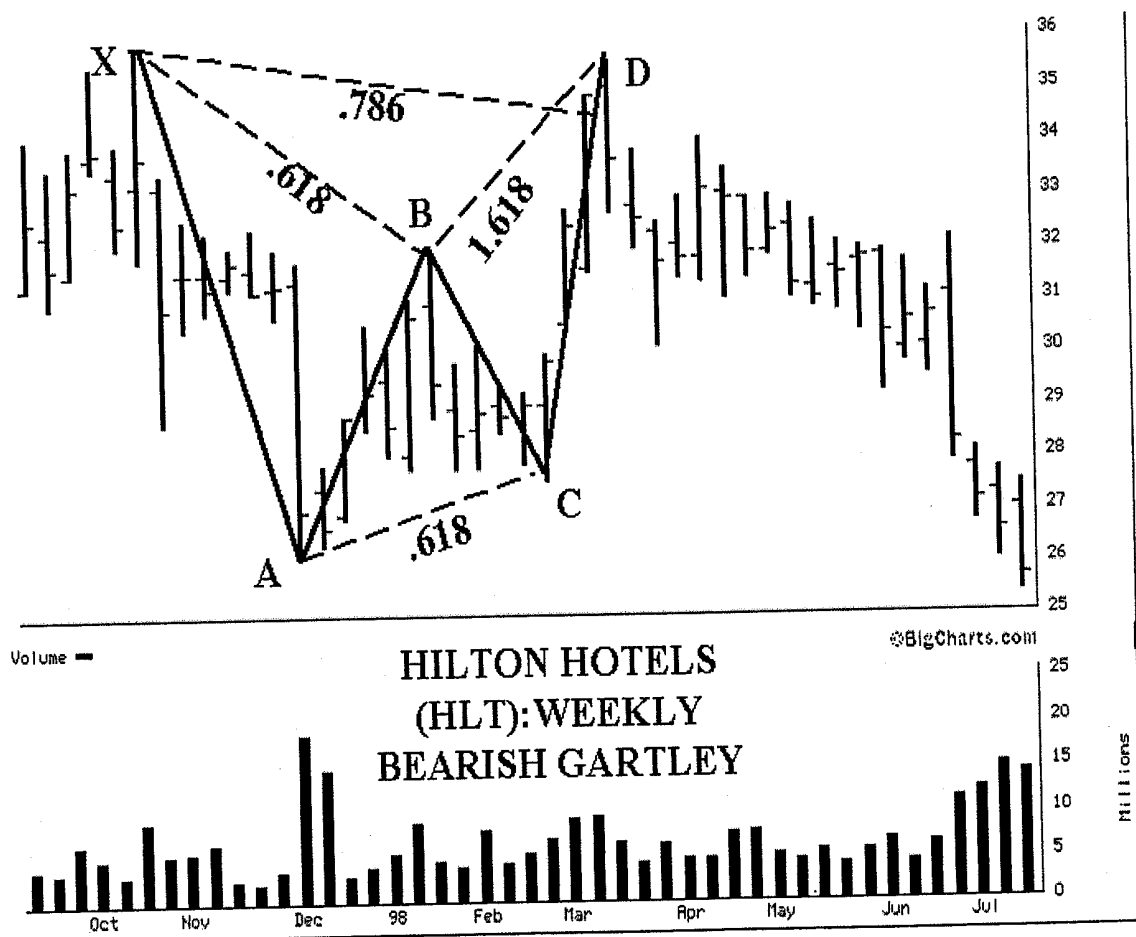

I wanted to include another enlarged chart of Hilton because the set-up illustrates an ideal reversal so clearly. Although the stock exceeded the potential reversal zone, it never broke above the initial point at X. In fact, on the week Hilton hit this area, the stock possessed two warning signs, an extreme price range and a tail close. With such a strong move up on this week, it would have been prudent to wait at least one price bar - a week - for a clear reversal sign, especially since it looked like the stock was going to blowout this harmonic area. However, on the following week the stock topped out, as evidenced by the obvious reversal bar.

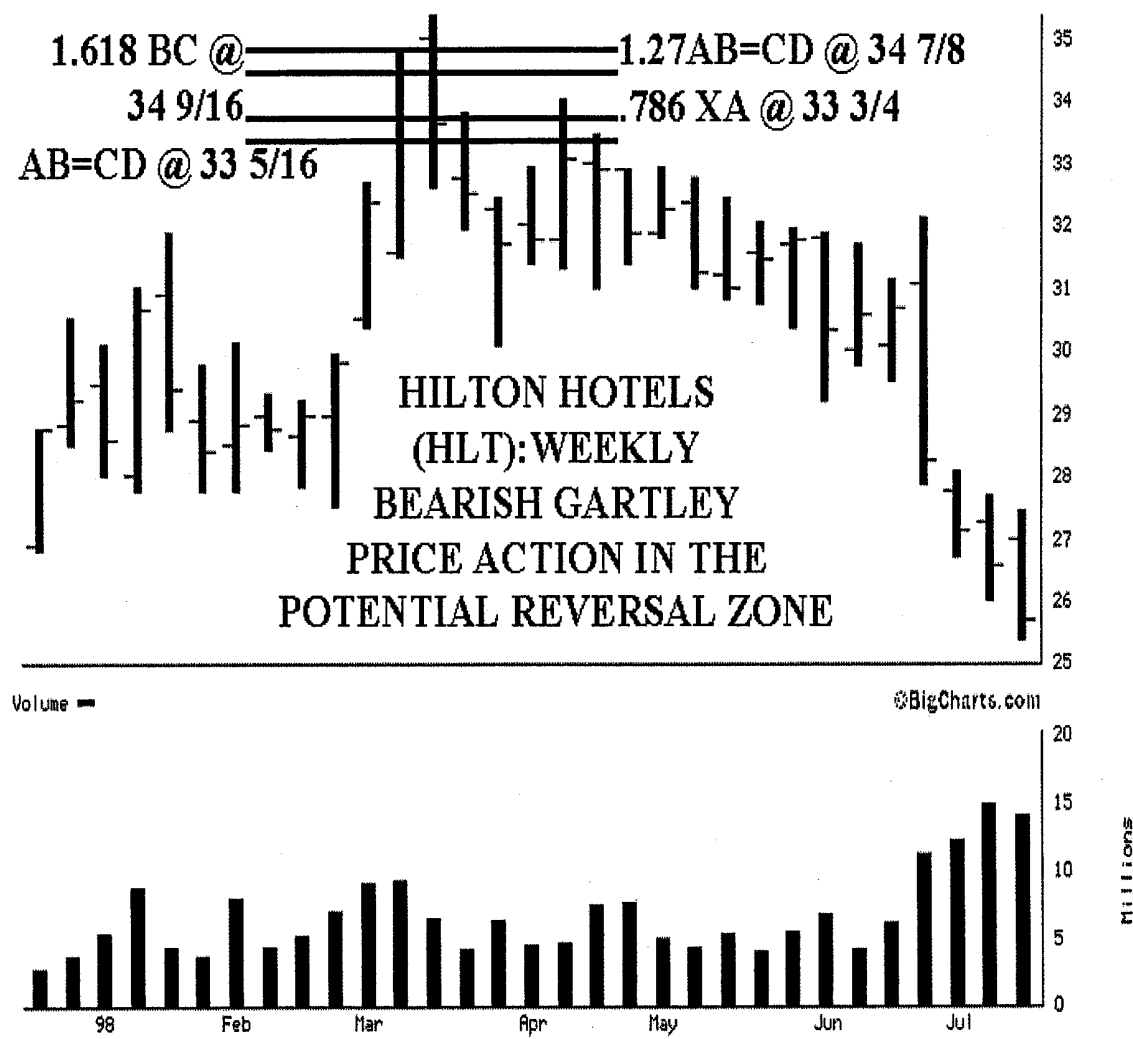

The other interesting aspect of this chart was the price action after Hilton reversed. As you can see on this chart, the stock clearly broke down, as it began to make lower lows and form bearish price bars in the weeks following the top.

I strongly recommend that you "go to school" on this chart example. The pattern was very clear and the reversal was very ideal. These opportunities will occur in the future. If you look hard enough, I guarantee that there is a set-up as clear as this one in the stock market right now. Furthermore, by studying this example, you will know what to look for in a valid reversal and put yourself on the right side of a very profitable opportunity.

The next chart example shows a nice bearish Gartley. Fannie Mae reversed on the day that it hit the potential reversal zone. The stock reversed after exceeding the .786 of XA by less than a point.

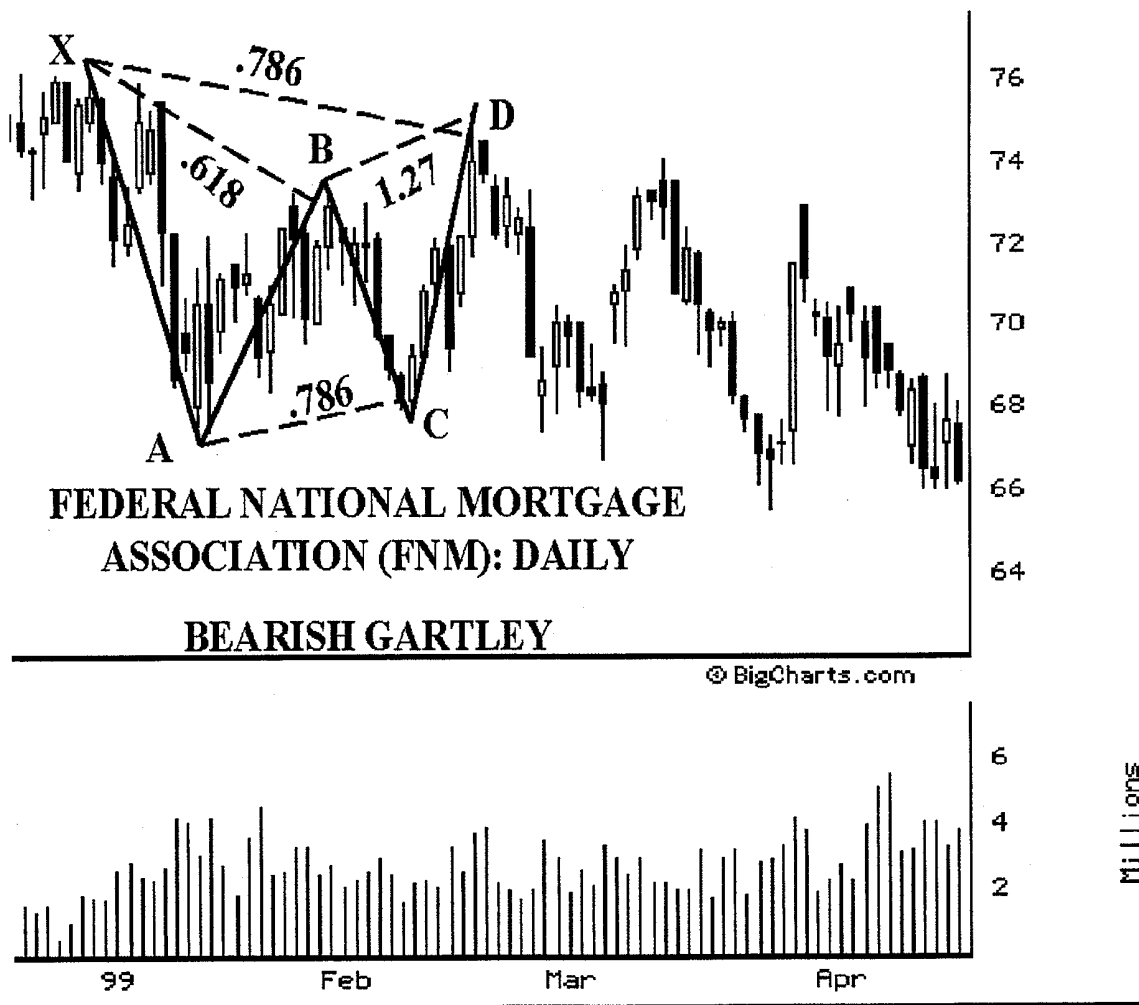

The potential reversal zone possessed three harmonic calculations. The .786 of XA was projected at $74 \frac{1}{4}$. The 1.27 projection of BC was calculated at $74 \frac{15}{16}$. The exact $AB=CD$ completion point was projected at $73 \frac{7}{8}$. So, the potential reversal zone was between $73 \frac{7}{8}$ and $74 \frac{15}{16}$.

Fannie Mae exceeded this area very slightly by only $3/16$ of a point, as the stock reversed at $75 \frac{1}{8}$. Your stop loss in this set-up would be just above point X – maybe around $76 \frac{1}{2}$.

The action was fairly strong on the day it hit the potential reversal zone, especially since the stock was up approximately three points. So, you probably should have waited one day. The next day signaled a potential reversal at hand, as the stock failed to continue its rally and formed a bearish candlestick. Within a few days, Fannie Mae started to break down, since it started to make lower lows. This pattern was a valid bearish signal, as the stock lost 10 points within the next few weeks.

Another example of a bearish Gartley is illustrated in the following chart of 3M Corp. The stock formed an ideal bearish Gartley that reversed almost exactly off the $.786$ of the XA leg. The $.786$ was projected at $84 \frac{15}{16}$, and the stock reversed after hitting $85 \frac{1}{16}$. This area was complemented by the 1.27 BC projection, which was calculated at $83 \frac{7}{8}$. 3M sold off rapidly, as it lost nearly 15 points within the following month.

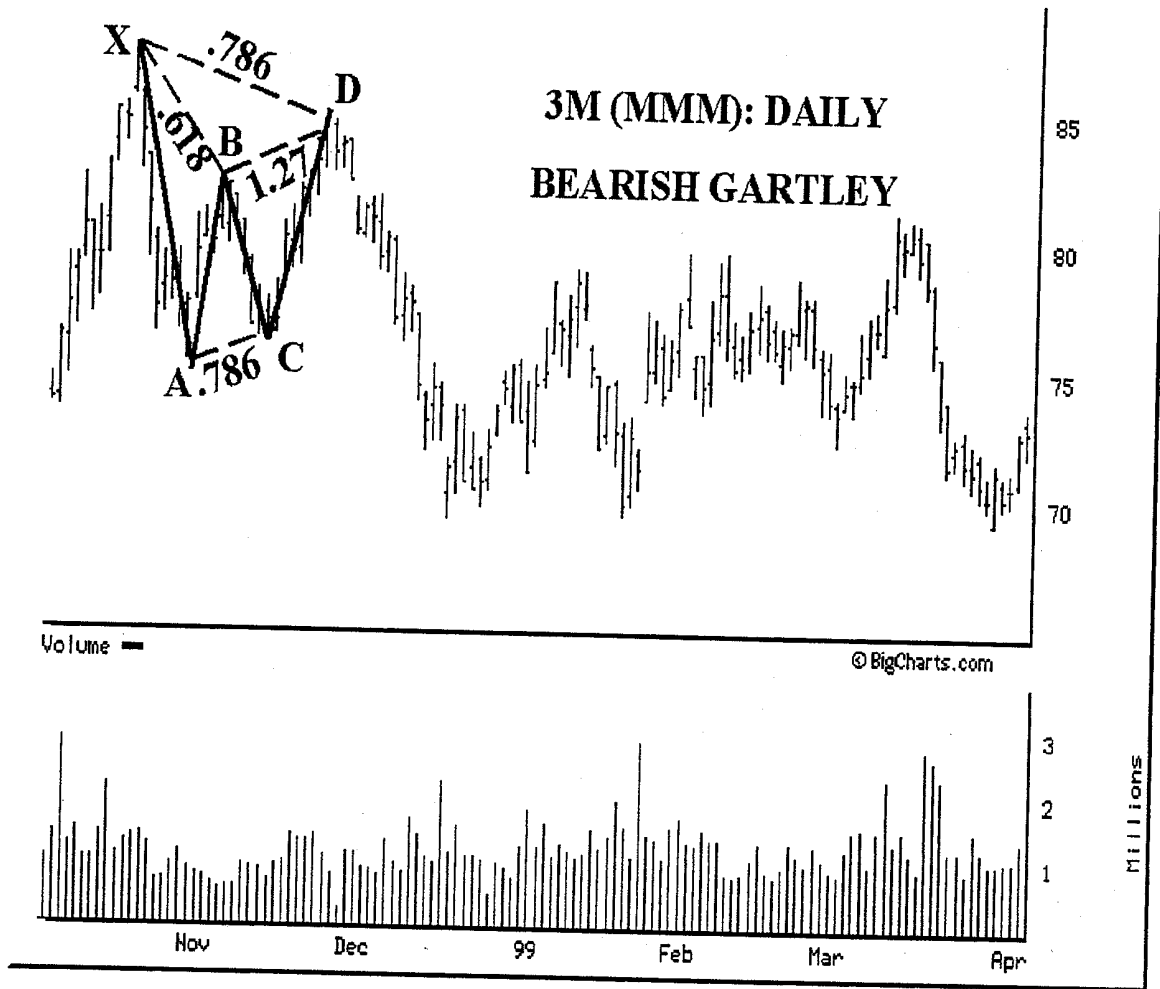

Another very harmonic element of this chart is that the stock reversed exactly off the 1.27 alternate projection of the AB=CD. Although I would have preferred an equivalent AB=CD, the alternate projection was calculated at 85 1/16 - the exact reversal point! When price action reverses off harmonic numbers exactly, the following move can be very powerful.

This is a very nice example of a bearish Gartley because the price action reversed off two of the most important numbers – the .618 and .786 retracement of XA by the AB leg and CD leg, respectively. The .618 retracement was slightly shy of the projected number but the .786 reversed almost exactly off this number. When these set-ups yield a reversal, the following price action can be quite strong.

I have enclosed an enlarged chart of the potential reversal zone that clearly shows the stock reversing off the XA projections. This is a good chart to study because it was a very nice pattern that reversed nicely off the potential reversal zone.

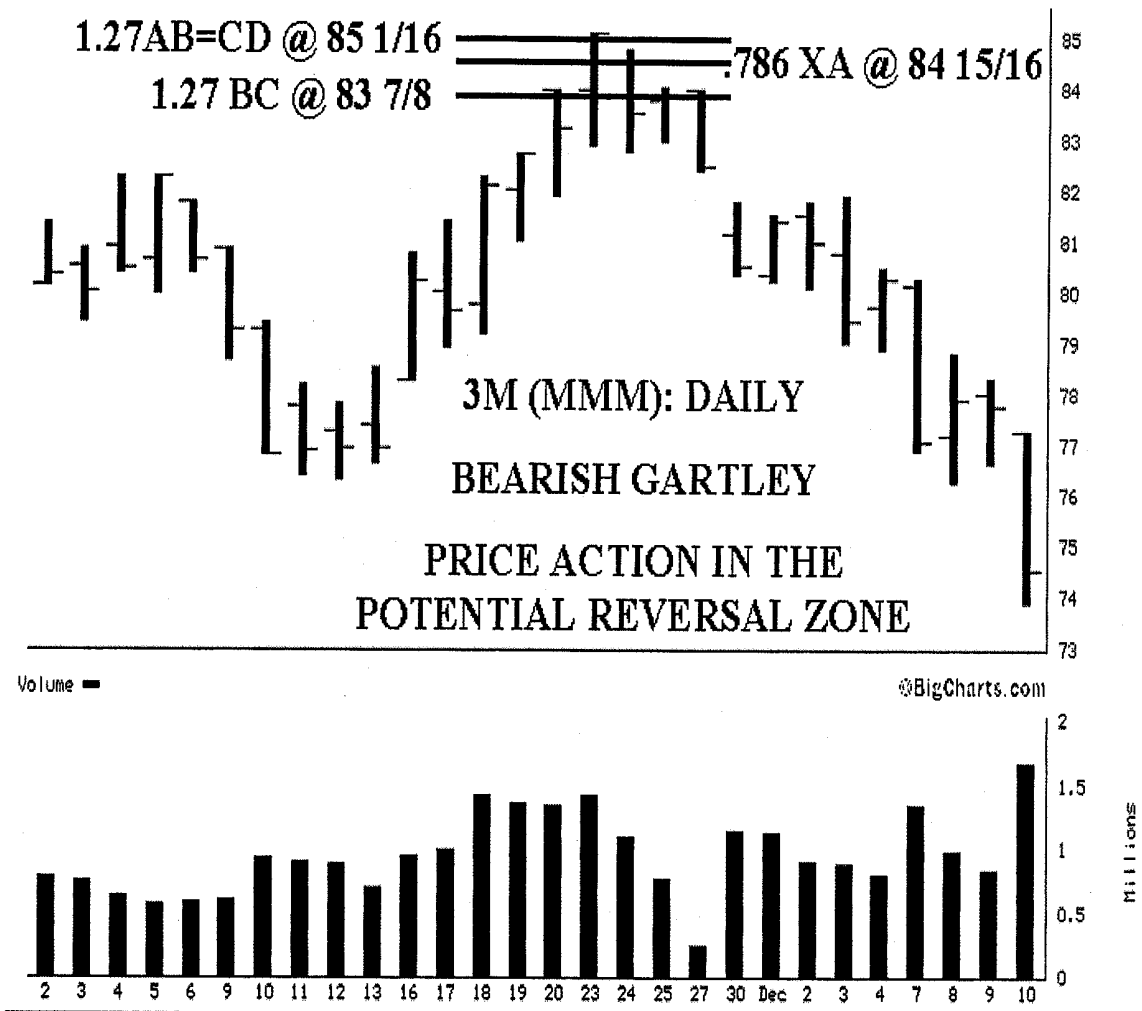

It is important to notice the bearish price bars that developed after the stock hit the potential reversal zone. The stock started to make new lows and failed to close above any of the prior days high. The price action was clearly indicating a reversal was at hand. Even if you waited a few days for reversal confirmation, you still would have been selling very close to a significant high in the stock.

The next chart of Intel formed a very nice geometric pattern that yielded quite a reversal. The stock reversed a point beyond a potential reversal zone that included three harmonic calculations. The most important number, the .786 of XA was projected at 65 3/4. This converged very close to the 1.618 of the BC leg at 65 1/2.

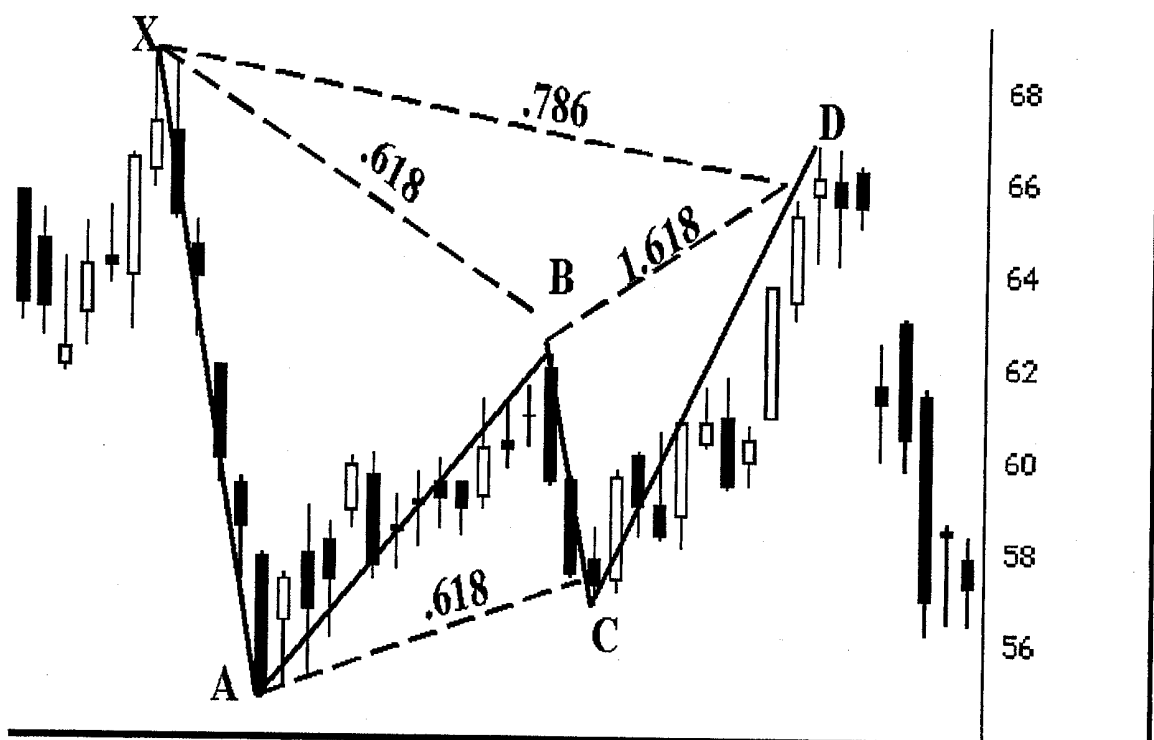

© BigCharts.com

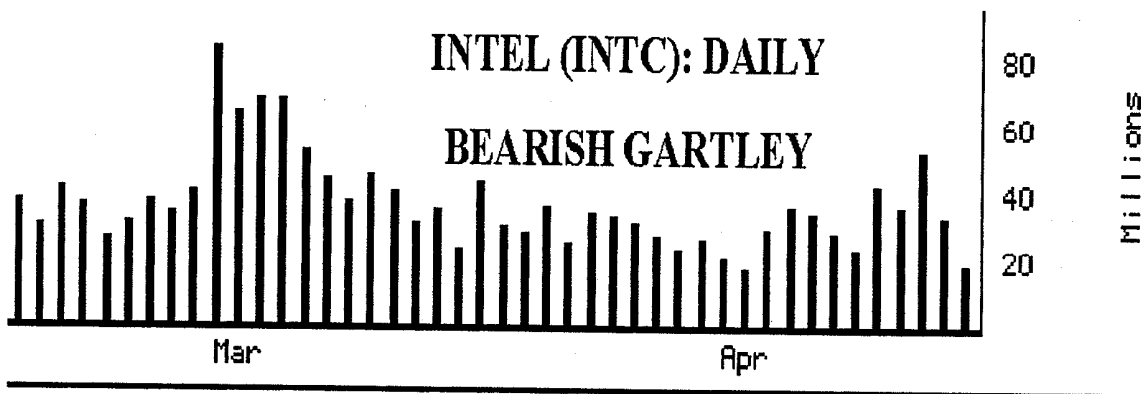

The AB=CD pattern was not exact but still harmonic. The AB leg was $7 \frac{7}{16}$ points. Unfortunately, projecting this exact length from point C at $56 \frac{7}{8}$ yielded a harmonic number that is about $1 \frac{1}{2}$ points below the .786. However, the 1.27 alternate calculation of the AB=CD pattern yielded a number that complements the .786 much better. This projection is slightly more than a $\frac{1}{2}$ point above the .786 at $66 \frac{5}{16}$. So, these three numbers defined an area between $65 \frac{1}{2}$ and $66 \frac{5}{16}$ for a possible trade execution. The stock reversed at $66 \frac{3}{4}$, which was a point above the .786 and less than a $\frac{1}{2}$ point above the 1.27 alternate calculation of the AB=CD.

Another interesting aspect of this set-up was the candlestick that formed in the potential reversal zone. On the day Intel hit this area, the stock formed a bullish hammer. The next day was even more significant, as the stock another bearish candlestick, and it could not continue its rally.

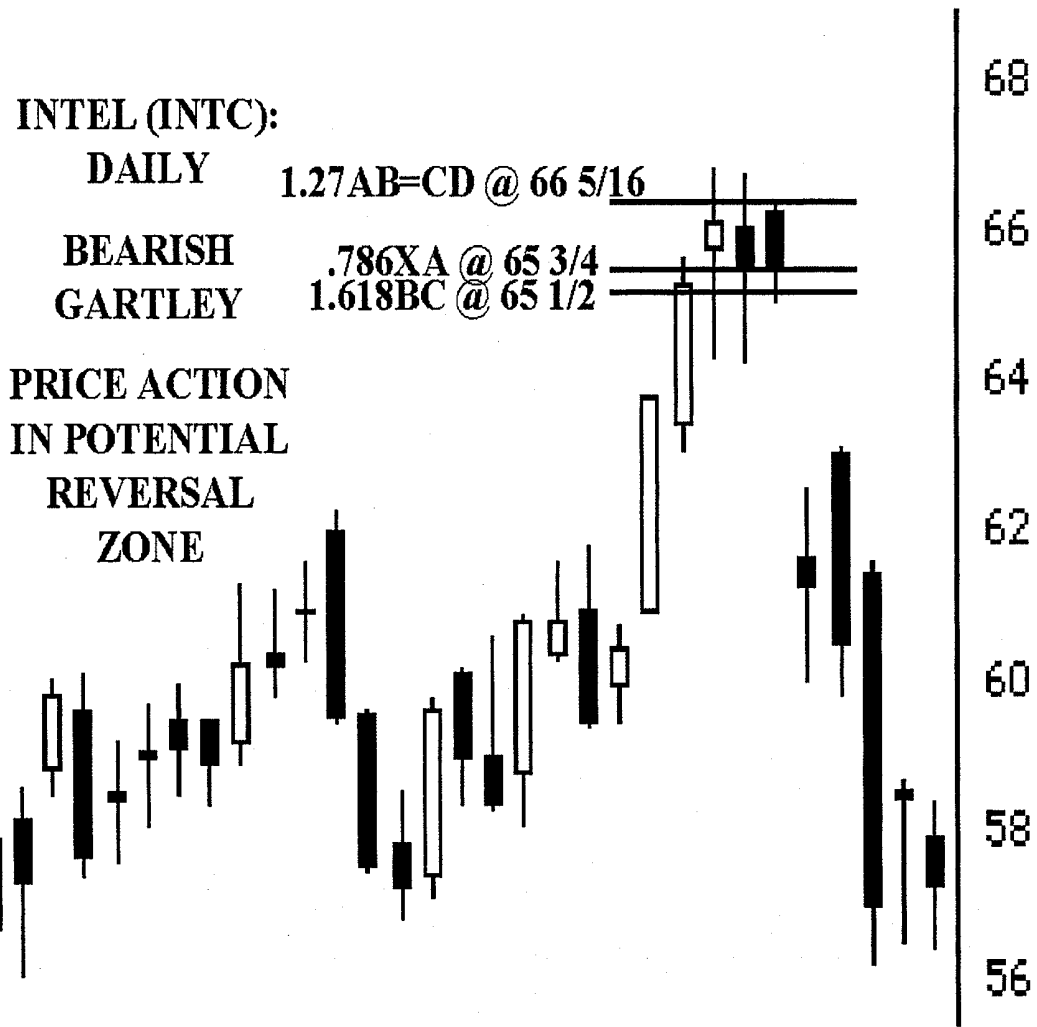

These price bar formations are the signals to look for to determine the validity of a reversal. Although the price action was quite strong the day it hit the potential reversal zone, the following two days indicated the reversal at hand.

In this situation, your stop loss was very limited. You probably would have closed out the trade if the stock exceeded the initial point (X) at 68 3/4. Depending on your perception of this set-up – which, I believe, was very harmonic – you probably would have placed your stop loss above 69. The stock did not test this level, and it reversed sharply within a few days after hitting the potential reversal zone.

In the next example, I included a chart of Warner-Lambert because the pattern was very clear but the execution was somewhat tricky. The .786 of XA was projected at 72 1/8, while the AB=CD was calculated at 72 3/4.

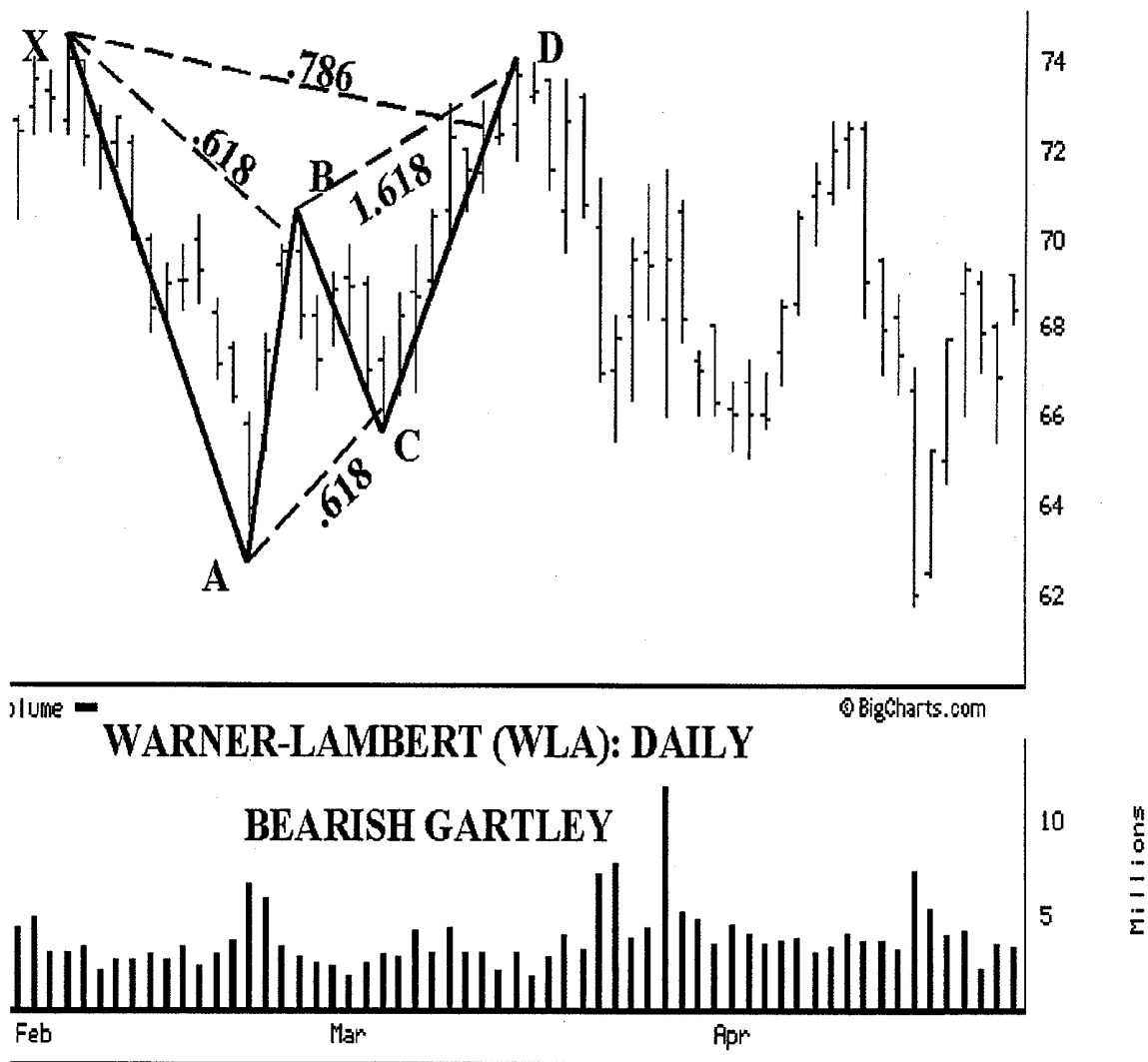

Since these two numbers were very close, you might assume that this would have been a good area to execute a trade. However, the price action was quite strong on this day. So, you might have waited an extra day to execute the trade.

The following day lacked any kind of bullish continuation, since the stock failed to make new highs. So, you short the stock on this day. The stock begins to rally and it seemed as if the trade is not going to work out. However, the stock failed to head much higher and it did not break above the initial point at X.

This situation underscores the importance of setting your stop loss before you execute the trade. In this case, the stop loss should have been just above point X – around 75. If you did not establish your stop loss above X, you might have covered your short at a small loss since the stock was rallying. But, the stock did not exceed this point. Although it took a little longer than usual for the stock to reverse, your trade would still have been profitable. Warner-Lambert reversed sharply and declined 8 points within the next two weeks.

In the ideal Gartley, the congregation of numbers and the $AB=CD$ pattern completion signifies a very harmonic set-up. When the price action hits the potential reversal zone, the individual price bars will indicate the nature of the move. If the reversal zone is not valid, the price action will show some warning signs, such as gaps, tail closes and/or wide price ranges. In the case of a reversal, the price bars should show some type of reversal, and the stock should reverse quickly after hitting this area. Moreover, a close that is past the .786 usually will signify that a reversal probably will not occur. Thus, the harmonic area is not a good trade opportunity.

Gartley after a Strong Price Move

This pattern is even more significant, if it is preceded by a major price move. Often, after a major price move, the Gartley will begin with a strong counter move, which becomes the X to A leg. The stock will appear to be consolidating, attempting to stabilize before making another strong move. If a Gartley forms after such price action, it has been my experience that this pattern will prove to be a substantial opportunity. In addition, the stop loss limit required in the trade will be relatively small relative to the potential reversal. The primary reason for this powerful opportunity is that a successful reversal will resume the longer-term trend that was established by the initial price move. Let's look at the diagrams.

Bullish Gartley after a Strong Sell-Off

The bullish Gartley after a strong sell-off is a difficult opportunity to perceive. When a stock forms this pattern, it might seem as if the stock is making lower highs, especially since point C is below point A after the initial bounce. However, the pattern is indicating a potential buy at the potential reversal zone.

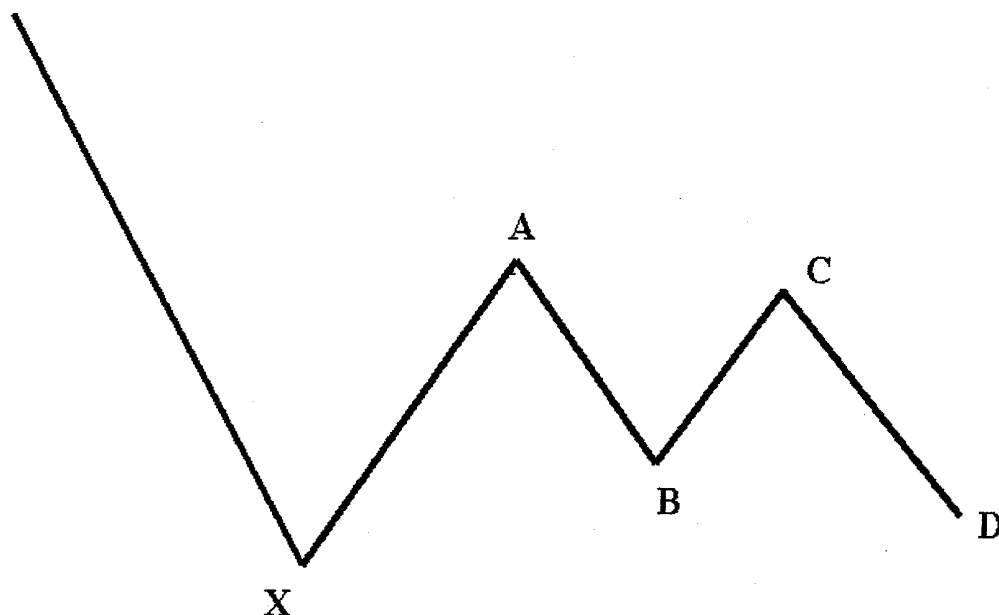

**BULLISH GARTLEY
AFTER A STRONG SELL-OFF
AB = CD
BUY AT POINT D!**

The beauty of this set-up is that it requires a very small amount of risk to see if the trade will work out. Since this is an unusually good set-up, the potential profit is very large in comparison to the amount risked. The stop loss should be placed just below X. The following examples will illustrate the effectiveness of this special Gartley situation.

This chart of America Online is an excellent example of a perfect Gartley after a severe decline. AOL sold off nearly 55 points preceding this pattern. In the following few weeks, the stock stabilized and then reversed sharply after completing a Gartley, as AOL rallied 40 points within the next month.

The potential reversal zone possessed three harmonic calculations that defined the set-up. The .786 of the XA leg was calculated at 57, which was the exact projection for the completion of the AB=CD pattern. In addition to these numbers, the 1.27 of BC was calculated at 56. So, the potential reversal zone was between 56 and 57. The stock reversed in this area at 56 3/8, and it rallied almost ten points the within the following two weeks.

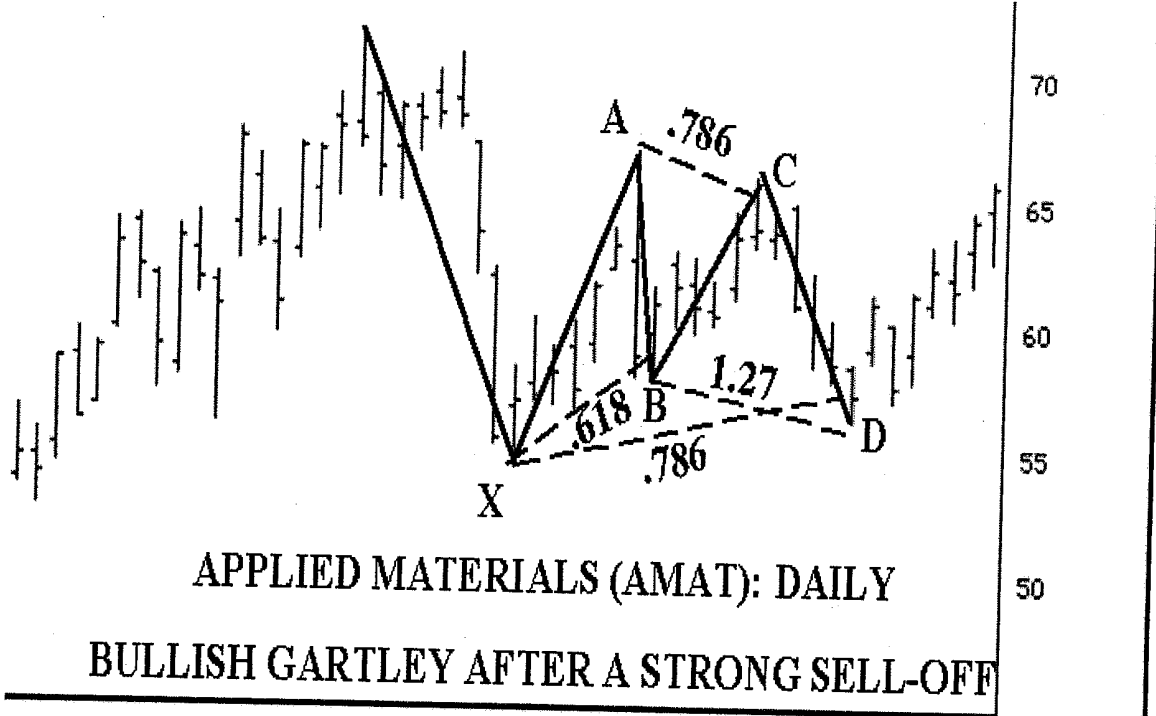

© BigCharts.com

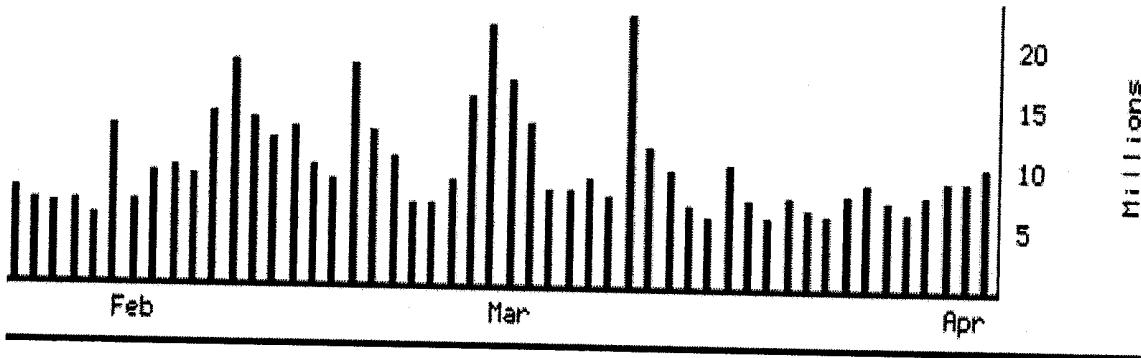

It is important to note that the stop loss in this trade was very small. The stop limit should have been placed just below point X around 54. Since the initial point at X was the low from the previous sharp decline, it represented significant support. If the stock broke past this point, it would be likely to assume that Applied Materials was breaking down and going lower. But, the stock held above this point and yielded a nice reversal.

The potential reversal zone possessed three harmonic calculations that defined the set-up. The .786 of the XA leg was calculated at 57, which was the exact projection for the completion of the AB=CD pattern. In addition to these numbers, the 1.27 of BC was calculated at 56. So, the potential reversal zone was between 56 and 57. The stock reversed in this area at 56 3/8, and it rallied almost ten points the within the following two weeks.

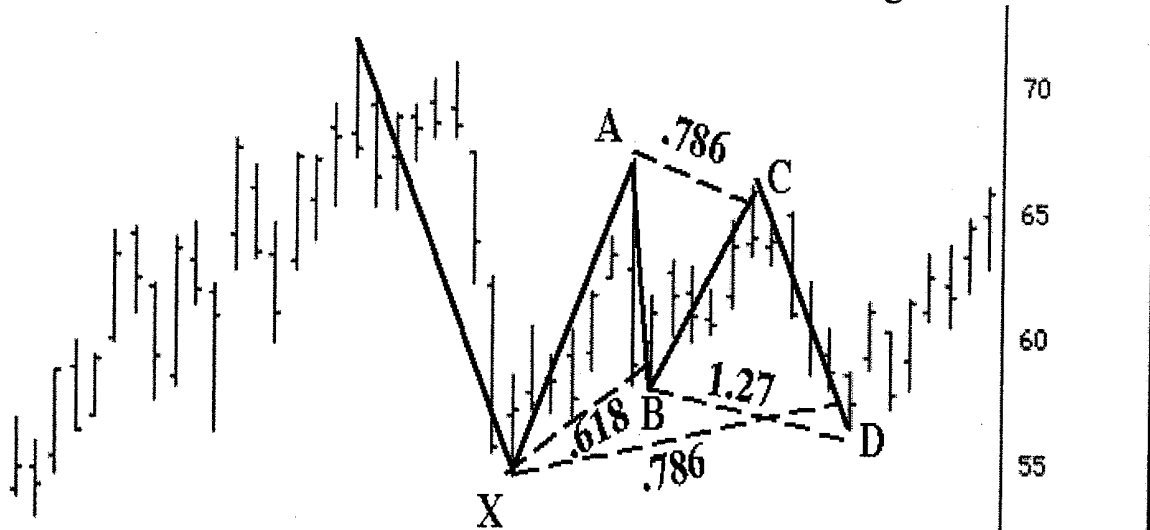

APPLIED MATERIALS (AMAT): DAILY

BULLISH GARTLEY AFTER A STRONG SELL-OFF

© BigCharts.com

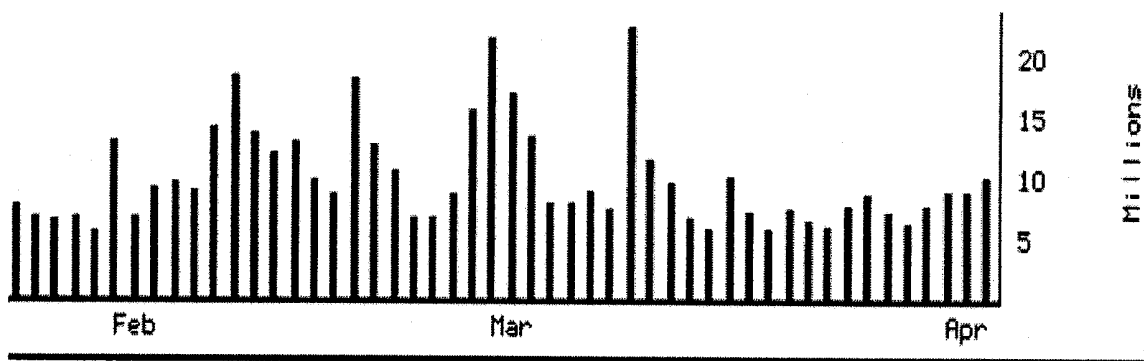

It is important to note that the stop loss in this trade was very small. The stop limit should have been placed just below point X around 54. Since the initial point at X was the low from the previous sharp decline, it represented significant support. If the stock broke past this point, it would be likely to assume that Applied Materials was breaking down and going lower. But, the stock held above this point and yielded a nice reversal.

Bearish Gartley after a Strong Rally

A bearish Gartley after a strong rally is a very powerful reversal signal, as well. In my opinion, this pattern is especially significant. Essentially, a stock that can't rally to new highs after a considerable move usually indicates serious weakness. Let's look at the illustration.

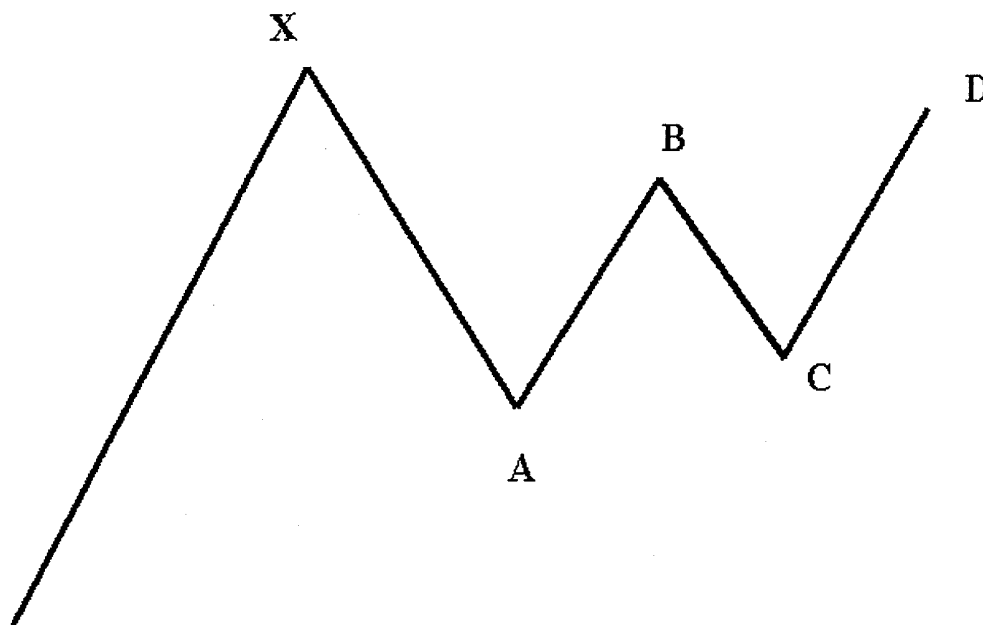

**BEARISH GARTLEY
AFTER STRONG RALLY
AB = CD
SELL AT POINT D!**

The pattern forms after a strong rally. In this set-up, point X is usually an important high for the stock. The pattern should complete in an area where several harmonic projections converge. Let's look at some examples.

IBM formed a beautiful Gartley after an amazing rally. In fact, the stock rallied nearly 75% in two months. After topping out at \$140 a share, the stock formed a beautiful pattern. The stock reversed after failing to break through the .786 of XA.

The potential reversal zone possessed three numbers within a precise area. The most important number, the .786XA was calculated at 134 9/16. The exact AB=CD at 132 7/8 did not converge near this number and the

stock rallied strongly through this area. But, the alternate $1.27 AB=CD$ calculation was much closer at $136 \frac{1}{4}$. Also, the $1.618BC$ was close to this area – calculated at $135 \frac{1}{32}$. The stock topped out at $137 \frac{11}{16}$.

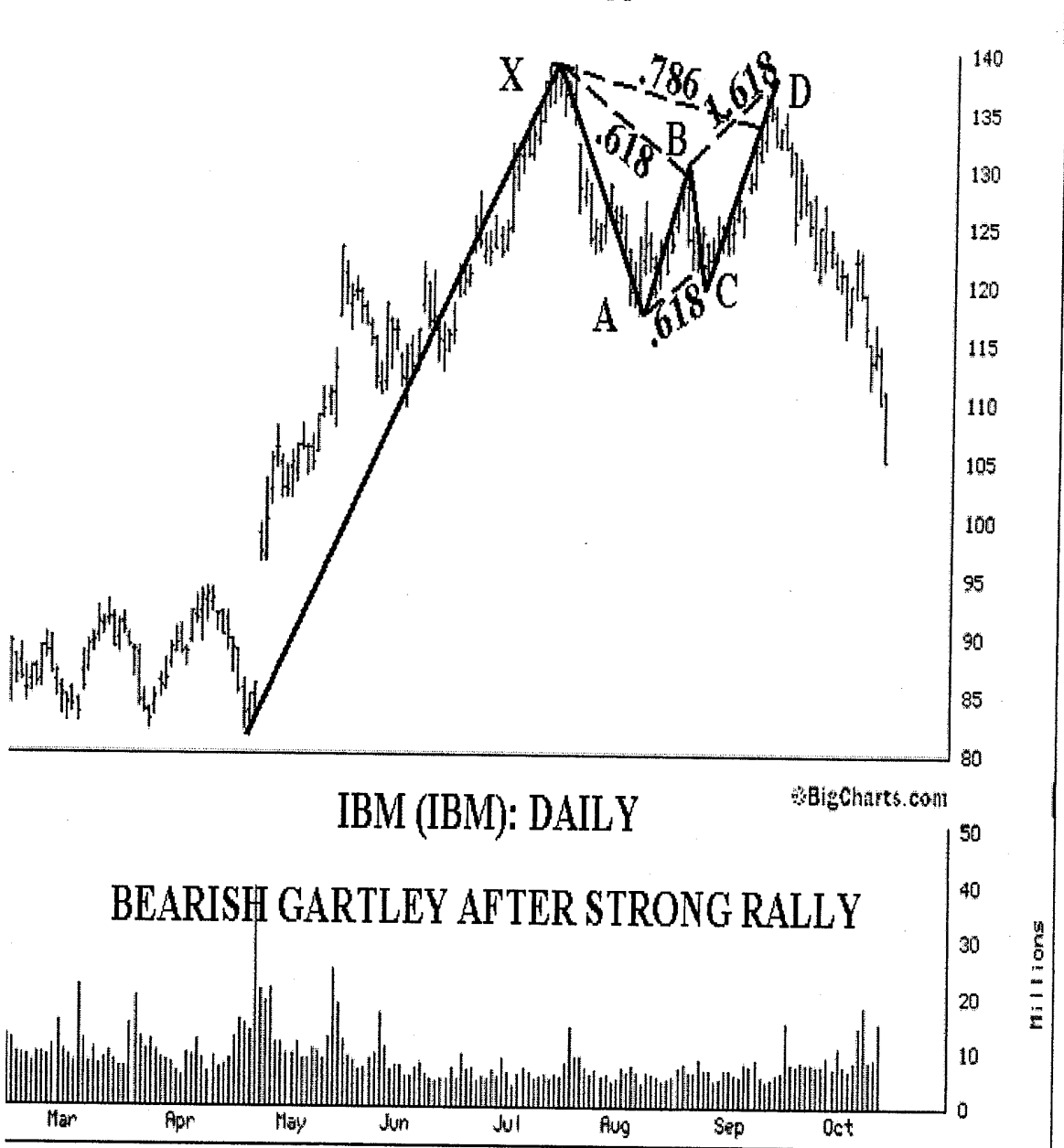

Although the potential reversal did not possess an exact $AB=CD$ pattern and the stock exceeded the $.786$ of XA , the pattern was very clear. This situation underscores the importance of setting your stop loss, which should have been placed just above the previous high. Due to the strong price action, IBM seemed as if it was going to rally into new highs. But, it didn't.

This enlarged chart shows the price action in the potential reversal zone. Clearly, the stock could not rally through this area and broke down sharply within days after completing the reversal.

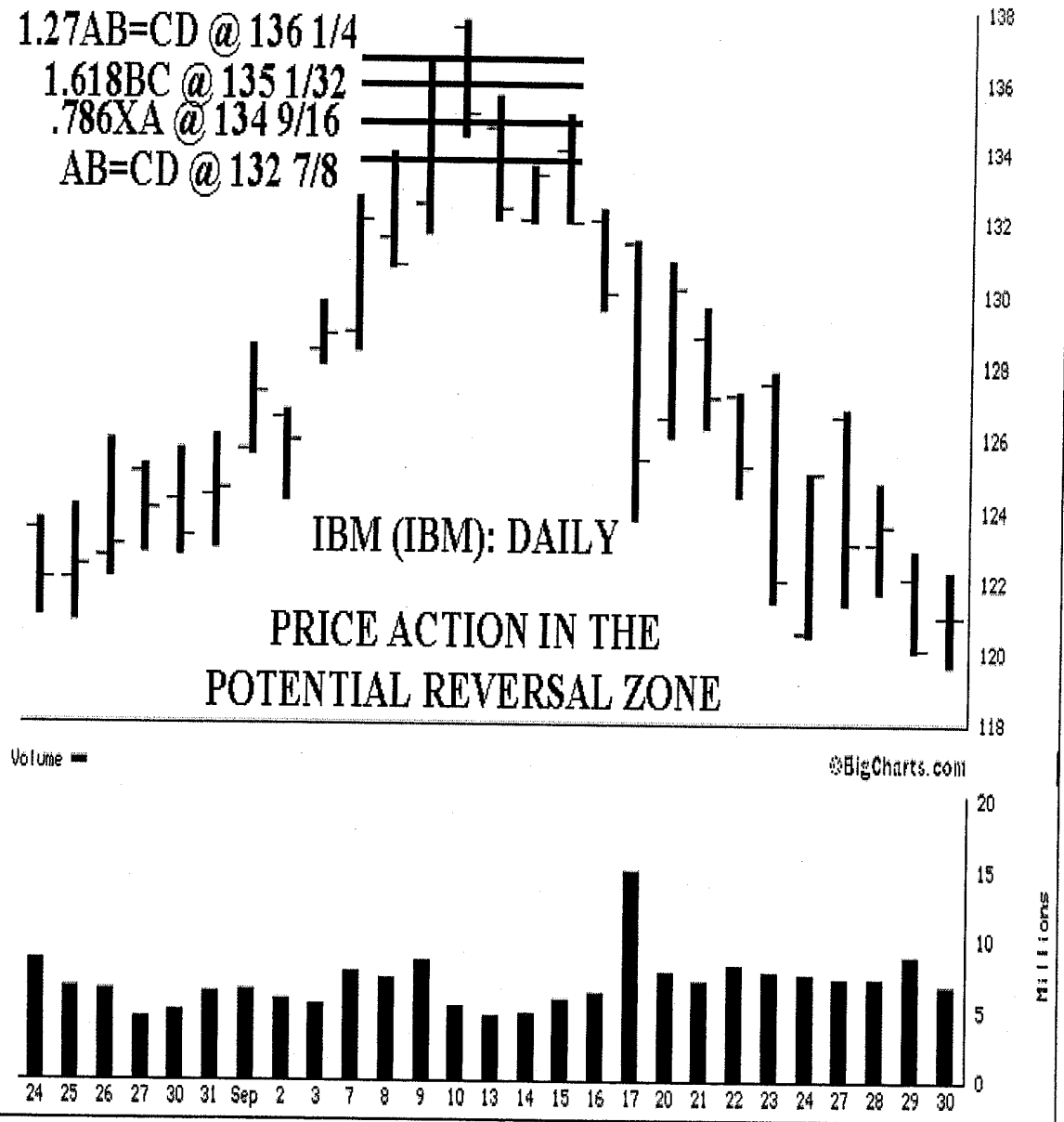

When such a clear pattern develops after an amazing rally like this one, you must realize that a significant opportunity exists. The Gartley could not have been any clearer. Even if you waited for the reversal to be confirmed, the set-up identified a great area to either take profits or get short.

The following daily chart of BMC Software shows a nice example of a bearish Gartley after a strong rally. The stock doubled in the year before the reversal and then topped out at $60 \frac{1}{4}$. After initially reversing and declining to a "panic" low at $34 \frac{7}{8}$, the stock tried to rally. It completed the bearish Gartley and reversed on the day it hit the .786 retracement of XA at $54 \frac{13}{16}$. BMCS reversed at $56 \frac{7}{16}$ and sold off sharply during the following several months.

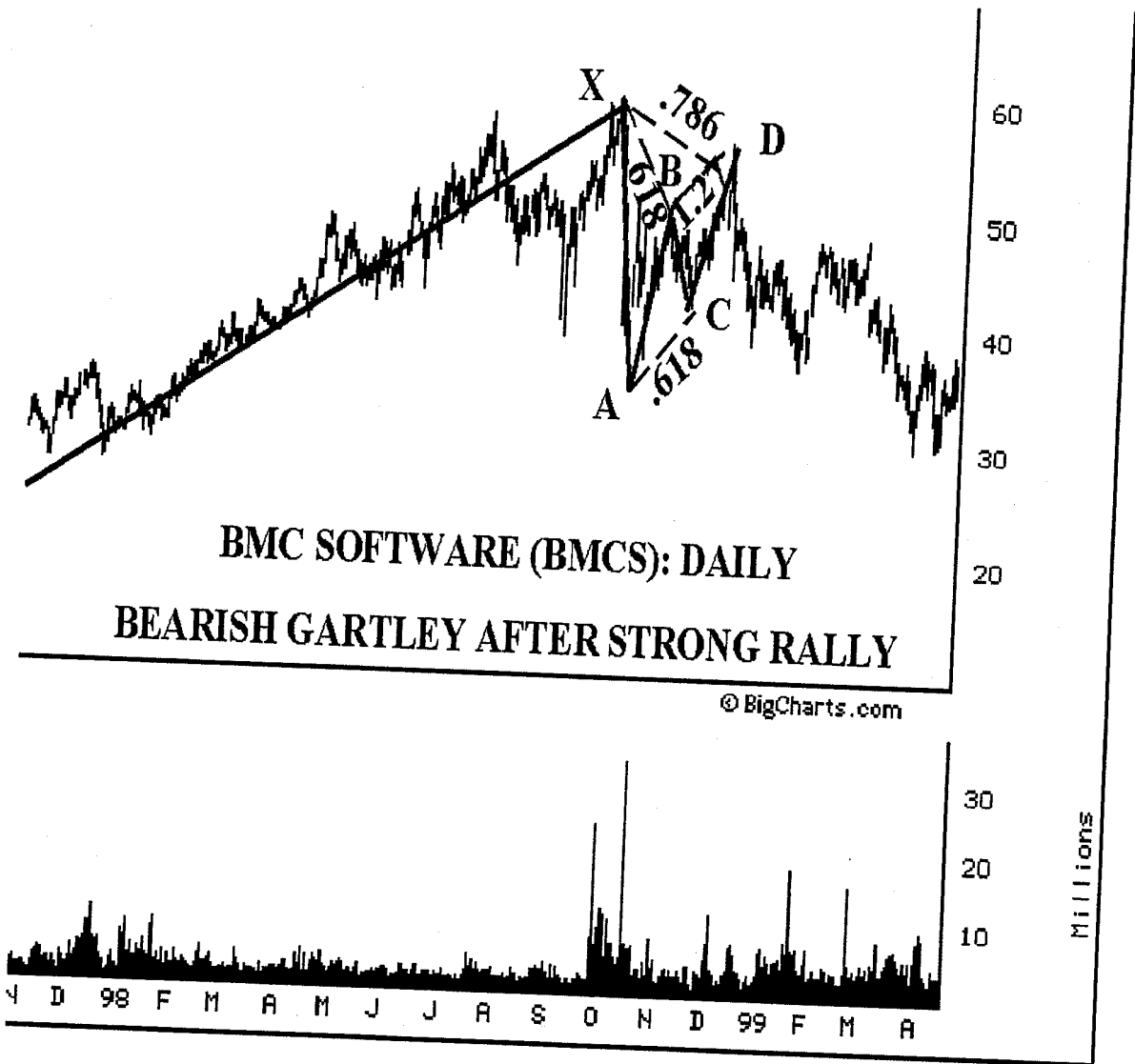

Many of these Gartley set-ups will appear during extreme market moves. It is very common for these set-ups to be defined very clearly with nice $AB=CD$ patterns. Therefore, when these set-ups materialize after a major price move, it is important to realize that these are highly probable set-ups.

Gartley Summary

The Gartley 222 is a fantastic pattern that occurs very frequently. In fact, it is probably the most prevalent of all of the patterns. The .618 retracement of the XA leg is the most important price leg of the pattern for several reasons. When point B reverses at the .618 of XA, the eventual BC projection will converge with the other key calculations, comprising the potential reversal zone. Specifically, the .786 of XA and the AB=CD will complete in this area.

The key in determining a valid pattern is gauging the price action at the convergence of the .786 of XA and the completion of the AB=CD. It is important to respect any warning signs that materialize in the potential reversal zone and closely examine the following price action after the stock hits this area.

In my opinion, I have observed bullish patterns yielding more significant reversals than bearish patterns. This may be due to the fact that the entire stock market has had a predominantly bullish bias for the past two decades. But, bearish Gartley patterns are significant reversal indicators that must be respected. I suggest that you study the examples presented in this chapter and research the pattern in other stocks. Valid reversals that result from this pattern do provide excellent opportunities for profit.

15

Butterfly

The Butterfly pattern is potentially a very strong reversal signal. The pattern was discovered by Bryce Gilmore and Larry Pesavento. According to Larry in his book, Fibonacci Ratios with Pattern Recognition, the pattern is nearly 80% accurate. Therefore, stocks that reverse following this set-up usually experience strong price moves. In fact, it is probably the most powerful of all the patterns.

There are several important elements that comprise an ideal Butterfly pattern. One of the most important conditions to identify an ideal Butterfly pattern is that it usually occurs near price extremes – either all-time highs or lows. This is important because reversals in these extreme areas are often reactions to a strong prior trend that has dominated the previous price action.

Although all-time price extremes are ideal set-ups, valid patterns often develop within established trading ranges. Another condition for a Butterfly to exist is that the completion point of the AB=CD can be frequently extended. In a Butterfly, the final leg will be the strongest and the longest. Although an equivalent AB=CD is a harmonic element of an ideal Butterfly, the alternate projections of either 1.27 or 1.618 can exist in the potential reversal zone. Therefore, it is important to be aware of these alternate calculations to more clearly define the potential reversal zone.

The Butterfly pattern incorporates several Fibonacci numbers that define the execution point. The reversal zone for a Butterfly may have as many as five harmonic numbers congregated within a very precise price zone. Such a harmonic set-up is very significant because, when a reversal occurs at the completion of this pattern, the following price action can be very strong.

In my opinion, the Butterfly pattern yields more significant reversals than any other pattern. Also, it is a very strong indicator for a potential reversal because there are usually at least three numbers in this harmonic area. Sometimes, the reversal zone possesses four or more harmonic projections.

It is important to note that the potential reversal zone for the Butterfly is not as precise as the other patterns. In fact, it can be larger than three points. Also, the pattern might require a greater stop loss limit. Therefore, when you trade these set-ups, you might want to permit a larger price zone for an execution.

Since the reversal zone is usually larger in this pattern, you might wait one price bar or for a clear reversal sign before executing a trade. Your patience will be rewarded because the pattern is a very harmonic set-up that often yields very significant reversals.

Bullish Butterfly

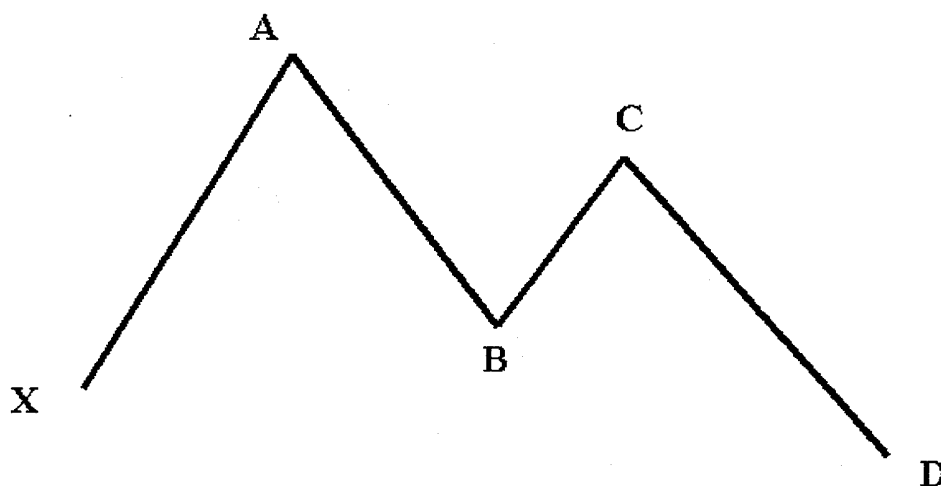

BULLISH BUTTERFLY

$AB < CD$

BUY AT D!

In a bullish Butterfly, the pattern requires that the points be located in specific areas. It is important to memorize this pattern because it can often resemble a Gartley. The pattern begins at point X with an initial move up to

point A, the highest point in the pattern. The $AB=CD$ starts from this point. An important consideration is that point C must not exceed point A. The most critical aspect of a bullish Butterfly is the completion point at D. This point will be the lowest – below all the other points in the pattern. This is one of the most distinguishing elements of a Butterfly versus a Gartley. Remember, in a bullish Gartley, the completion point completes above the initial point at X.

The $AB=CD$ pattern will usually require an alternate calculation - usually a 1.27 of the AB leg. At a minimum, I prefer to see an exact $AB=CD$ pattern within the Butterfly before executing a trade. The $AB=CD$ pattern - exact or alternate - will converge with other harmonic numbers and define an excellent buying opportunity.

Bullish Butterfly Stop Loss

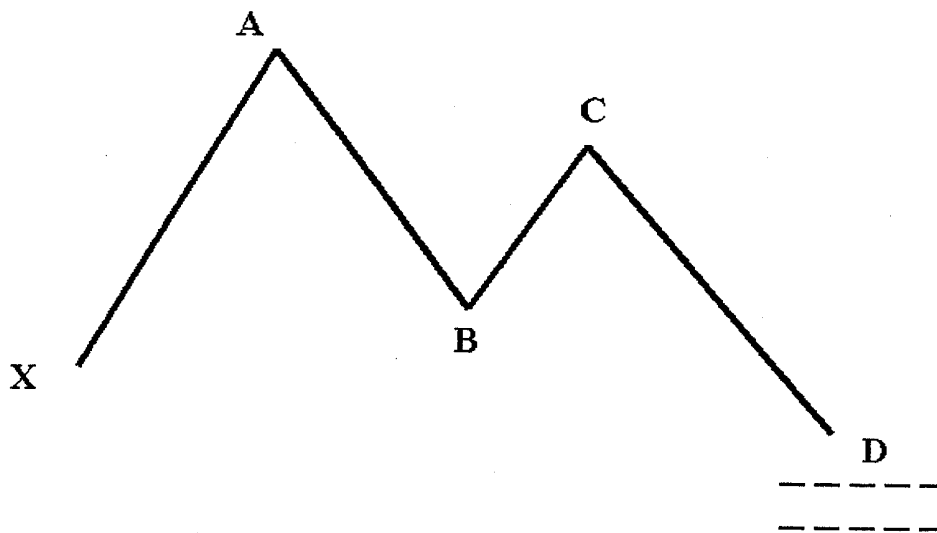

BULLISH BUTTERFLY WITH STOP LOSS

$AB=<CD$

STOP LIMIT BELOW D!

The stop loss in a Butterfly is more difficult to determine than the other patterns. Unlike the Gartley, which has a critical price point at X to gauge the validity of the pattern, the Butterfly lacks such a relative measure. Since a Butterfly pattern usually occurs at price extremes, there is no prior price action to define support or resistance. So, the stop loss limit in a

Butterfly depends more on the current price action within the potential reversal zone.

In general, the stop loss for a Butterfly should be larger than the other patterns. Sometimes, depending on the set-up, the stop loss in a bullish pattern can be more than two points below the potential reversal zone. The key in defining the stop loss limit is really a personal question and is usually different for everyone.

Essentially, it is the amount a person is willing to risk to see if the trade set up is going to work. One person might be willing to risk more than another based upon their perception of the opportunity. In this set-up, the CD leg can become extended and sell off past the harmonic projections. Therefore, it is important place the stop loss below the potential reversal zone in the bullish Butterfly.

Ideal Bullish Butterfly

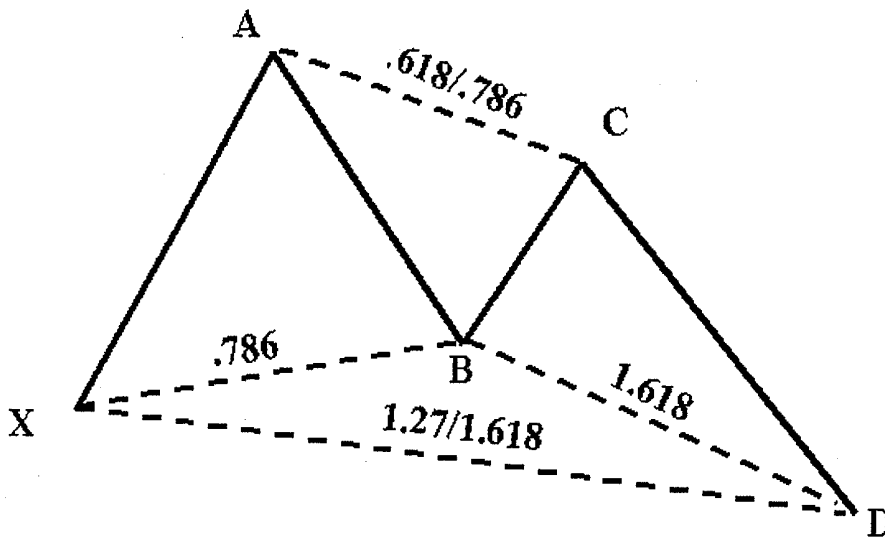

BULLISH BUTTERFLY

AB=<CD

BUY AT D!

The ideal bullish Butterfly occurs frequently in stocks that are making important bottoms. In an ideal set-up, a bullish Butterfly will be found in an

all-time low area. I have seen this pattern in many stocks that seem to be extremely weak but reverse significantly.

When a stock does reverse in an all-time low price area, the following rally is often incredibly strong. As I have previously stated, this is probably the most powerful of all of the patterns. The following examples will illustrate the effectiveness of this pattern in defining important reversal points.

The following weekly chart of Novellus clearly illustrates a very harmonic bullish Butterfly. The potential reversal zone included several harmonic calculations, including a major alternate $.786AB=CD$.

The most important number in this set-up, the 1.27 of the xa leg, was projected at 22 9/16. The 1.618 of the BC leg complemented this harmonic projection at 20 1/16. The smaller $ab=cd$ within the Butterfly coincided very close with the 1.27, which was projected to complete at 23 1/2. As Novellus declined into this area, you should have prepared to buy the stock.

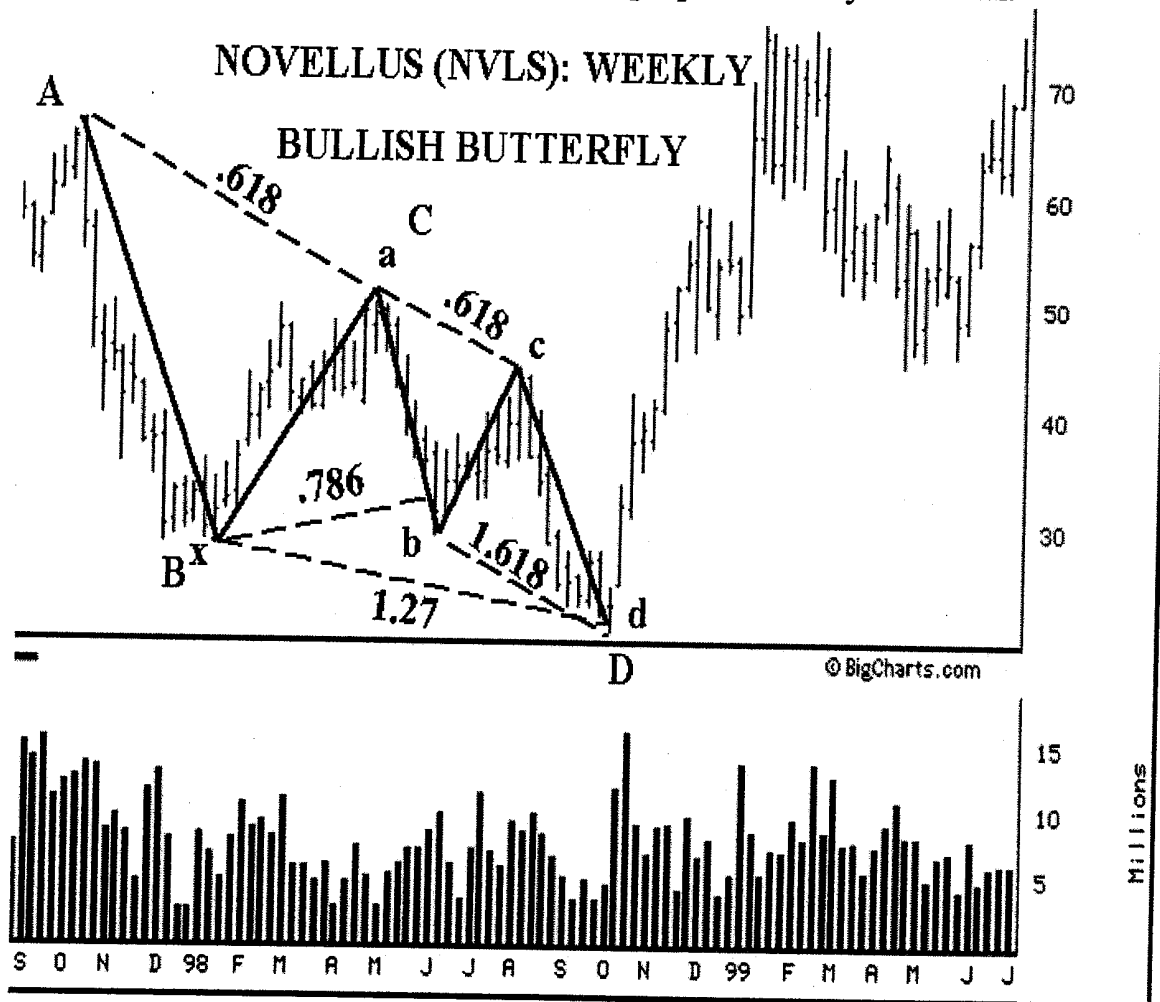

Interestingly enough, there was a larger $AB=CD$ alternate projection that was in this area, as well. The $.786$ of the AB leg resulted in a completion of the CD leg at $20 \frac{5}{8}$. Although this number is not as significant as the 1.27 of XA , it does provide further evidence of a harmonic set-up just above 20 .

Another indicator of the reversal was the price action as the stock entered into the potential reversal zone. After declining quite sharply for several weeks, Novellus started to stabilize. On the next enlarged candlestick chart, the weekly price action revealed that a reversal was at hand.

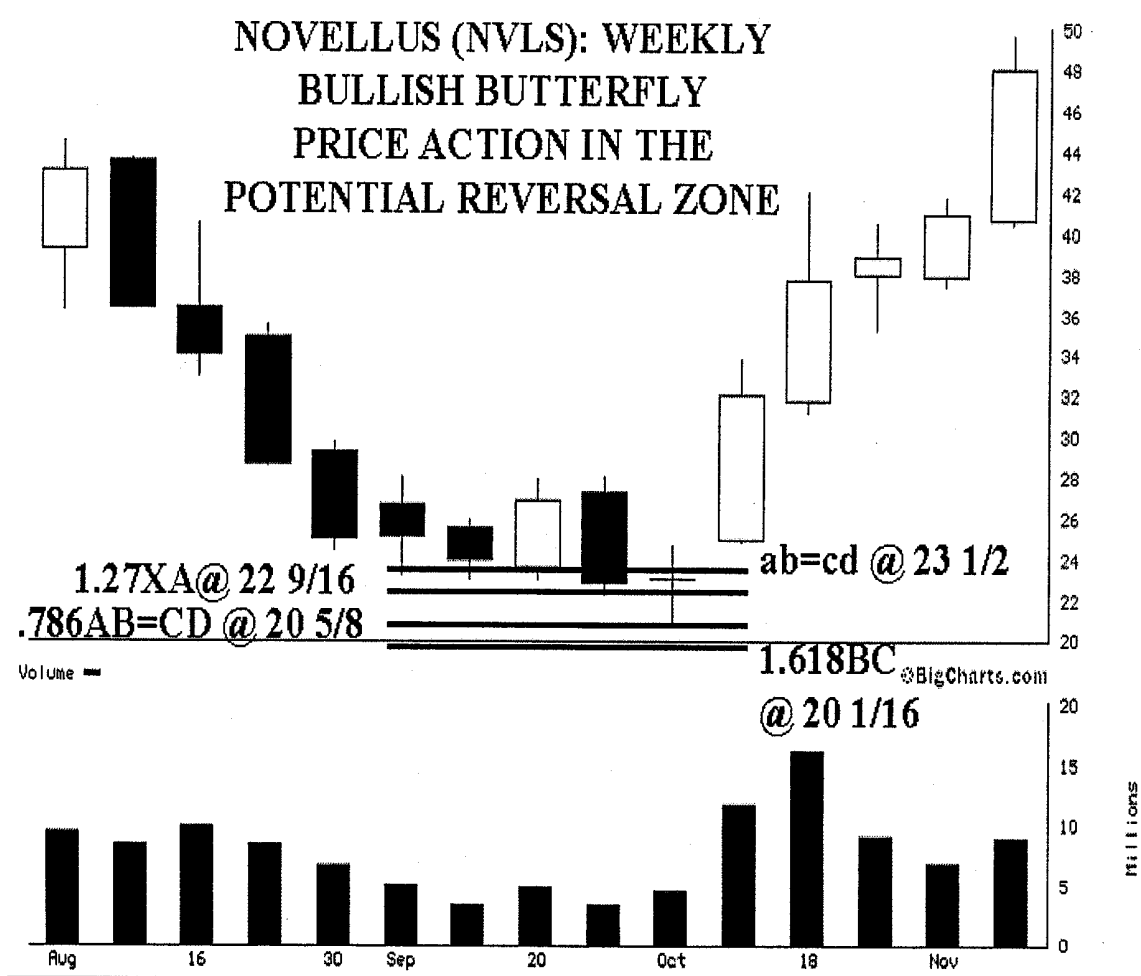

A significant aspect of this reversal was the doji that formed the week before the stock broke out. A doji price bar occurs when a stock opens and closes at the same price. In a potential reversal zone, it is an excellent indicator of a change in trend.

It is important to note that this pattern developed during most of 1998. When such a lengthy pattern materializes, a valid reversal will often yield a significant move. This is a very nice set-up because there were four harmonic calculations converging in the low 20s. Clearly, Novellus reversed quite nicely off this area. Even if you waited a week or two for a clear reversal price bar, the potential reversal zone identified a significant bottom that yielded a fantastic move over the following six months.

The next chart illustrates the pattern well, as Egghead.com completed an ideal bullish Butterfly that possessed several harmonic numbers in a very specific area.

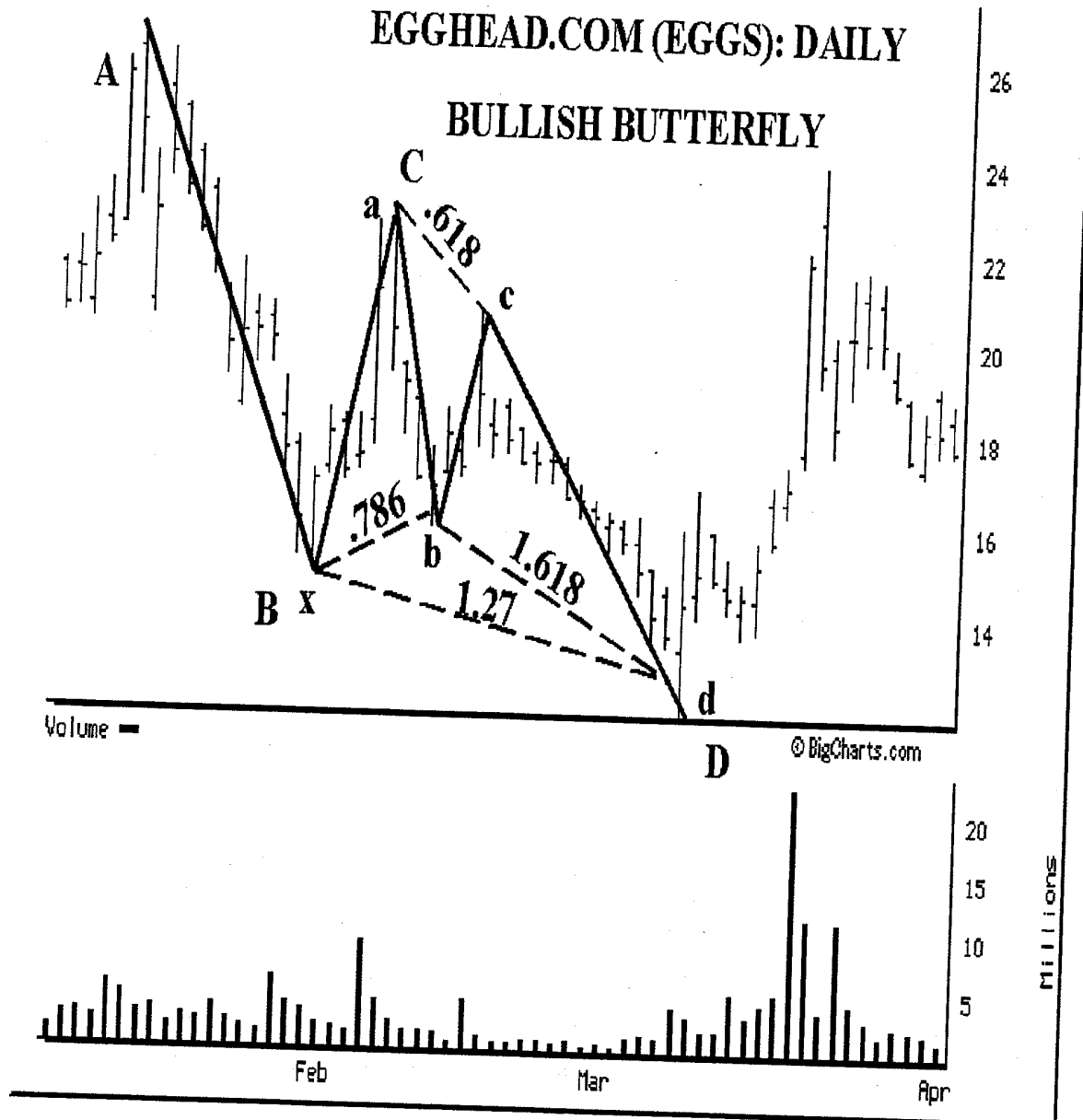

The potential reversal zone for this pattern was projected between 11 3/16 and 13 1/8. The most important number, the 1.27 of the XA leg was projected at 12 15/16, while the 1.618 of the BC leg was calculated at 13 1/8. Another important harmonic calculation was a major AB=CD pattern that was projected to complete at 11 3/16. In fact, this major AB=CD contained a smaller ab=cd.

Although the smaller ab=cd required an alternate 1.27 calculation, it was still within a point of the larger AB=CD. The 1.27 of the ab leg resulted in the projected completion at 12 1/8. So, these four numbers defined a potential reversal area that was within 1 15/16 points. The stock hit 12 and reversed sharply. This enlarged chart clearly shows the bullish price action in the potential reversal zone that started the new uptrend.

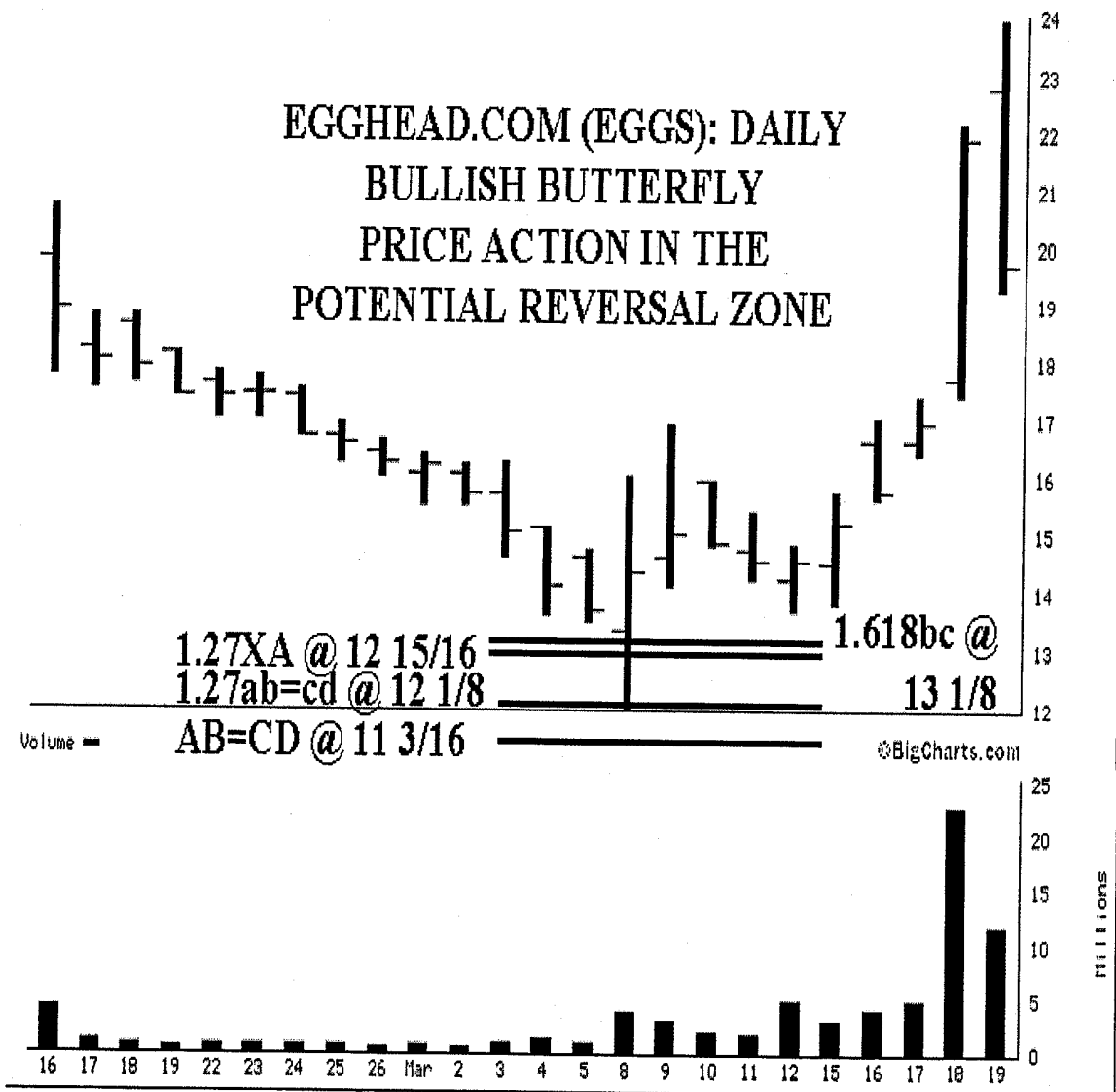

It is important to note that the stock hit every number in the potential reversal zone, except the completion point of the major AB=CD, all in the same day. Another interesting aspect of this set-up is that the stock clearly reversed on this day. When a stock reverses with such a bullish close - above the open and the prior day's close, you must realize that this price action is significant. It should indicate that the stock has bounced and completed a valid reversal.

The stop loss in this situation was not that difficult to determine because there were so many harmonic numbers converging in a specific area. I believe that the major AB=CD served as a key area to determine the validity of the trade and essentially defined the stop loss limit.

Since the Butterfly pattern indicated a potential buying opportunity between approximately 12 and 13, the stock should have reversed in this area. However, the addition of the major AB=CD suggests that the stock could reverse somewhat lower. Therefore, your stop loss probably should have been placed below the completion of the major AB=CD - maybe around 10 1/2.

The stop loss could have been even lower due to the volatility of the price action. I think if the stock declined past 10, the set-up would have been invalidated. However, the stock never tested this area and bounced sharply, as EGGS doubled within a month after reversing.

When you observe the combination of two patterns converging near each other like this, you must assume a high probability for a reversal. Although you probably had to risk a greater loss limit, the potential reversal in these situations can be quite significant. It is important to recognize these opportunities as more harmonic than usual, and can be potentially a more profitable set-up.

The next chart of Broadvision clearly illustrates the significance of the pattern. The stock completed an ideal bullish Butterfly in October 1998 and rallied 700% in the following six months. Incredible! Butterfly patterns are very strong reversal signals. When they do work out, Butterfly patterns can be very profitable opportunities!

This pattern developed near an extreme price level (all-time low) and the set-up possessed all of the elements of an ideal Butterfly. This pattern was a very ideal set-up because the potential reversal zone included several numbers just below 11. The 1.27 of XA was projected to complete at 10 3/4. This number was complemented by the 1.618 of BC at 10 15/16 and the 1.27 alternate AB=CD at 10 7/8.

The most important number, the 1.27 projection of the XA leg, was probably the best point to buy. But, this was a tricky execution because the day the stock hit the potential reversal zone the price action was quite extreme. So, in this case, you probably should have waited a day for a clear reversal bar to enter the trade. The stock declined slightly past this point, as Broadvision did not reverse until it hit 9 1/4 a few days later.

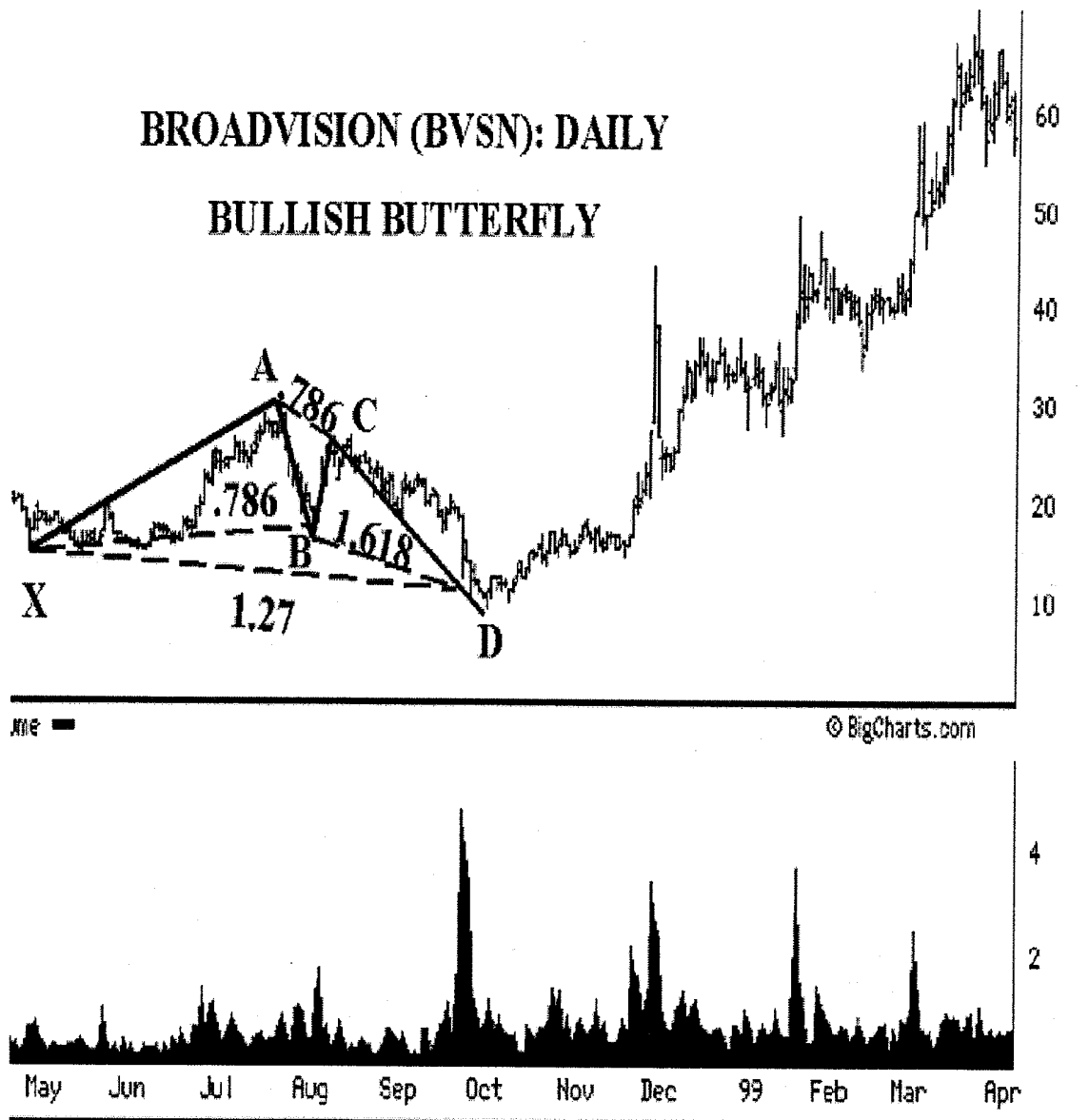

I included a close-up of the price action. It is important to study this example because it was such an ideal pattern. Despite the fact that the stock exceeded slightly the potential reversal zone, it still was a very harmonic set-up.

This close-up of Broadvision shows that the stock could not decline past the potential reversal zone. Although the day the price action hit the zone was extreme, the stock lacked a bearish continuation. Broadvision found support just below the projected harmonic area, and reversed within the following few days.

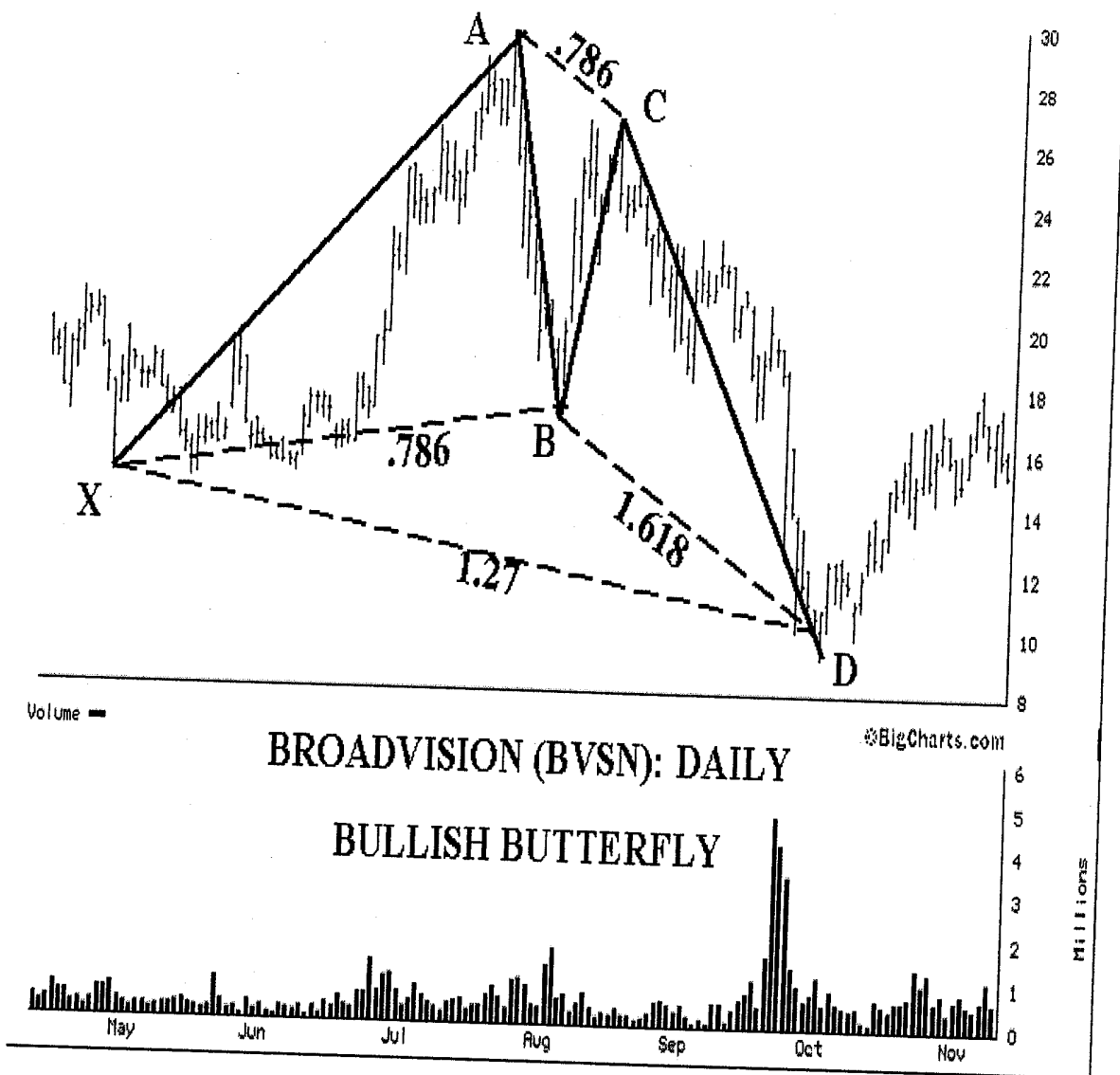

This example demonstrates the importance of respecting the warning signs of price gaps, tail closes or extreme price ranges. Since Broadvision sold off sharply the day it hit the reversal zone, possessing a warning sign in the form of an extreme price range, you probably should have waited until a bullish price bar established a clear reversal.

Bearish Butterfly

In a bearish Butterfly, the points must be aligned properly to define a valid pattern. Again, the most important point is the completion point at D. This must be above all of the other points in the pattern.

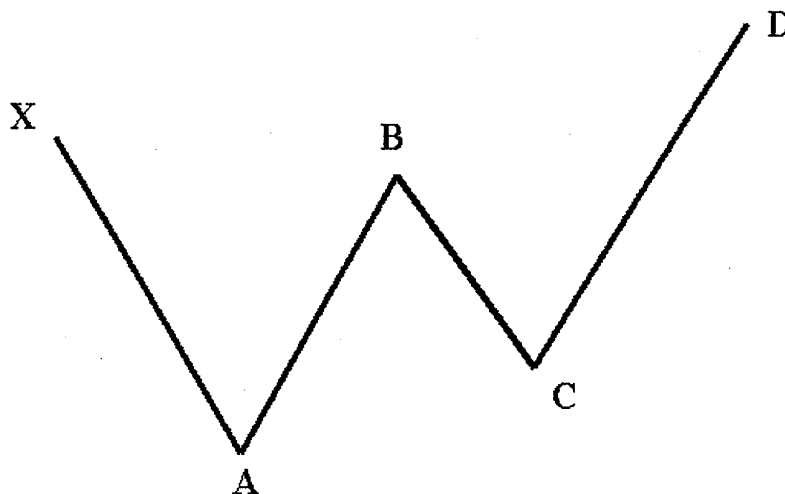

BEARISH BUTTERFLY

$$AB = < CD$$

SELL AT D!

As the illustration demonstrates, the X to A leg will establish the main range for the following price action. Similar to the Gartley, point A should not be exceeded by point C. Also, as the diagram illustrates, point D must exceed both points, X and B.

Similar to the bullish pattern, the $AB=CD$ usually will require an alternate calculation. Since ideal Butterfly patterns occur at extreme price ranges (all-time highs or lows), the CD leg usually will experience an extreme price move and can become over-extended. I do wait for the completion of the exact $AB=CD$ at a minimum before executing a trade. For now, I suggest that you memorize the basic geometric pattern. This basic framework appears frequently in many stocks that are establishing critical reversals.

Bearish Butterfly Stop Loss

In the bearish Butterfly, a stock will often rally through the potential reversal zone and become extended. Although this may happen, if the pattern is valid, the reversal should occur quickly. So, it is important to allow a large enough stop loss limit to allow the stock to indicate whether or not it will reverse. Again, although you might risk more than other patterns in this set-up, a valid reversal will usually be quite significant. Let's look at the diagram.

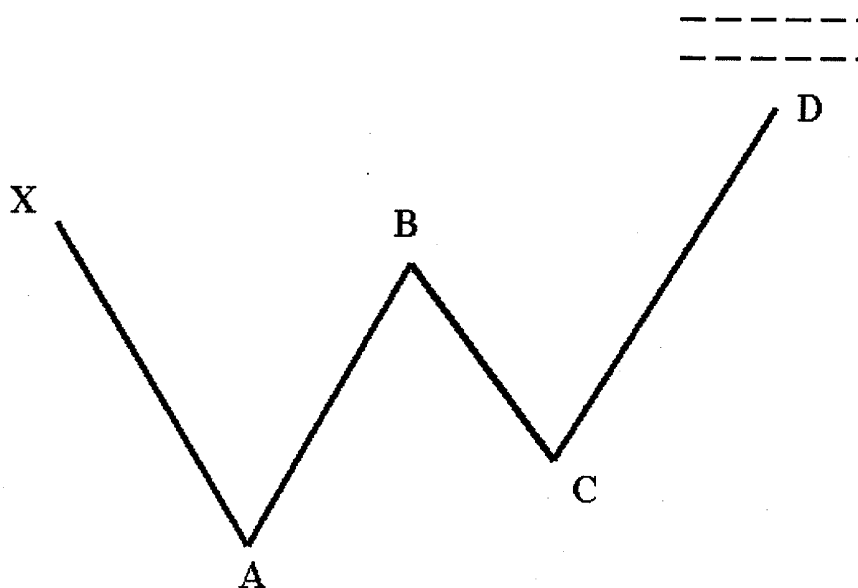

BEARISH BUTTERFLY WITH STOP LOSS

AB=<CD

STOP LIMIT ABOVE D!

Although larger stop losses are advantageous in certain trade set-ups, I can't emphasize enough that the actual stop loss limit must be defined clearly before executing the trade. Whether you place an actual stop with the initial trade or maintain the limit mentally, your loss must be quantified. If you don't quantify your loss, you do not know how much you are willing to risk. If your risk is not defined, you are prone to experience more loss than is necessary because, when you do cover a losing position, your actions will more likely be based upon emotion – usually fear.

Ideal Bearish Butterfly

The ideal bearish Butterfly is a significant pattern, especially when it completes in an all-time high area. Bearish Butterfly patterns will define a specific selling area – usually within three points.

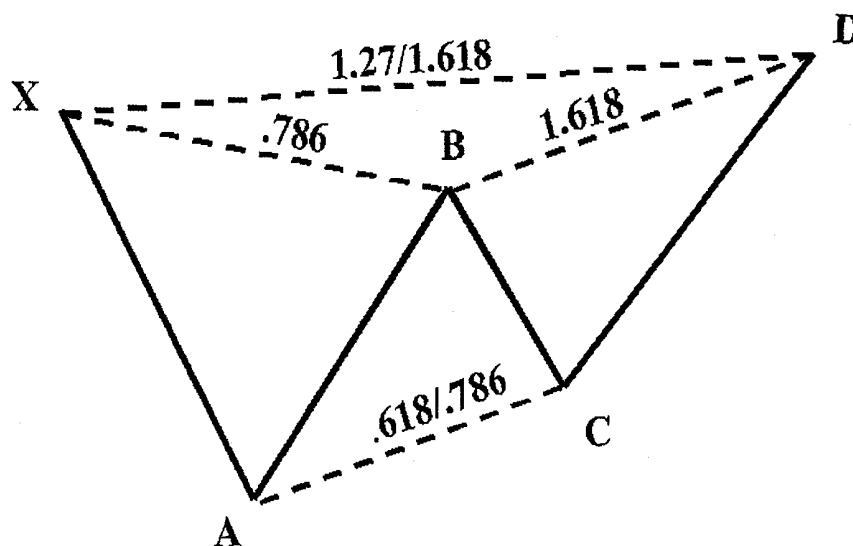

BEARISH BUTTERFLY

$$AB = < CD$$

SELL AT D!

It is important to wait for a stock to hit the 1.27 projection of the XA leg at a minimum before entering a trade. Sometimes, a stock will reverse slightly shy of the 1.27. So, as the stock is approaching the 1.27, it is important to watch the price action closely. The most important aspect is to study the potential reversal zone. If several harmonic projections exist within a few points, a reversal is very likely. Also, the $AB = CD$ will often require an alternate calculation when the pattern is not exact. Let's look at some examples.

This chart of US Airways illustrates the ideal bearish Butterfly very clearly. In this set-up, the potential reversal zone was in a very specific area. The 1.27 of XA was projected at 62 1/4, which closely coincided with the 1.27 alternate calculation of the AB=CD at 61 15/16. The 1.618 projection of the BC leg was calculated at 63 7/8. So, the potential reversal zone was approximately 2 points between 61 15/16 and 63 7/8. The stock exceeded this area by an 1/8 of a point, as it reversed at 64.

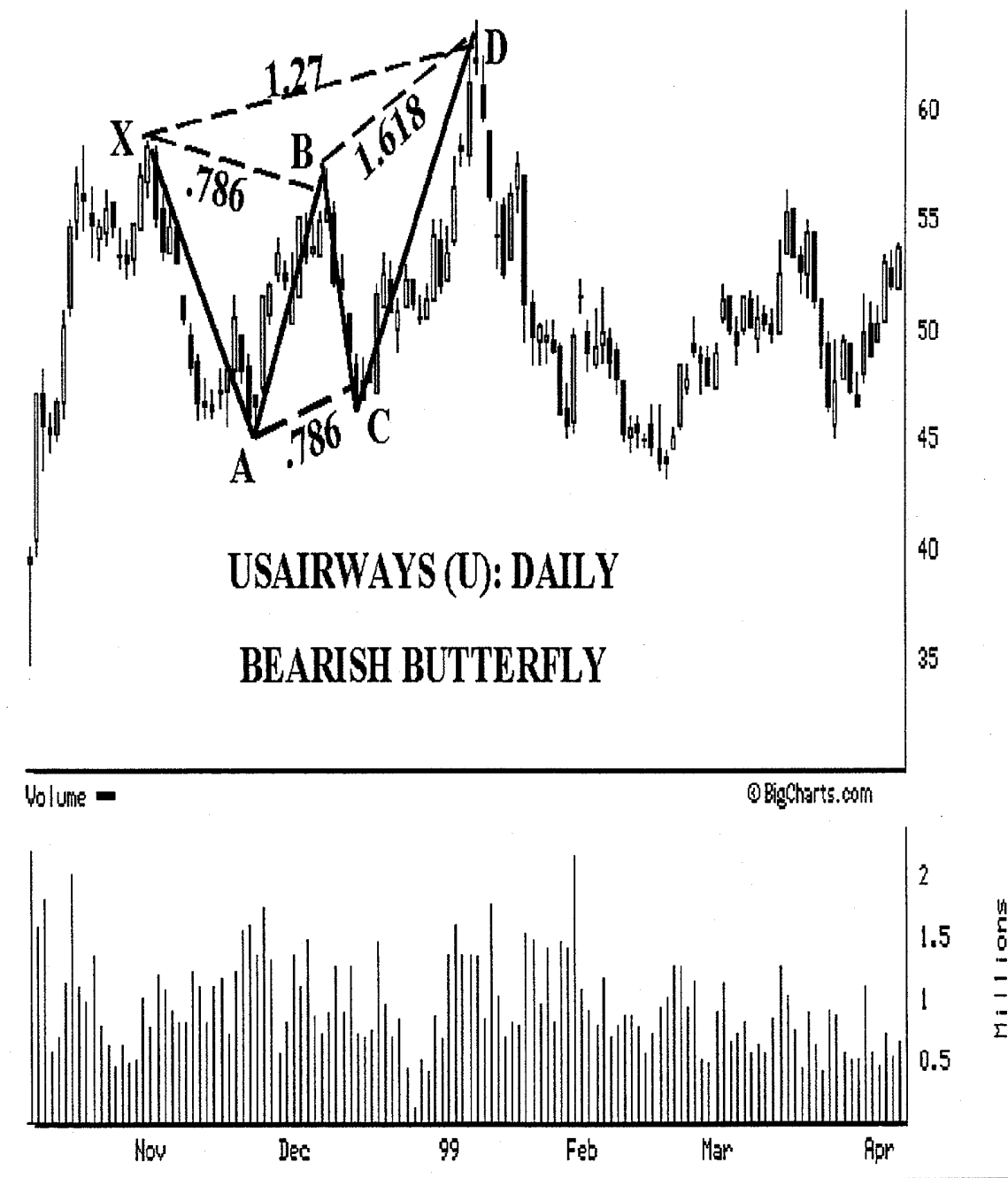

It is important to note that the stock hit the 1.27 projection of XA the day before it reversed. The stock experienced a warning sign in the form of an extreme price range. In fact, the stock was up nearly 4 points at the high of this day. Therefore, you probably should have waited an extra day before executing the trade.

I have included the following enlarged chart of the price action in the potential reversal zone. On the first day the stock hit the potential reversal zone, the price action was quite strong, as US Airways was up several points.

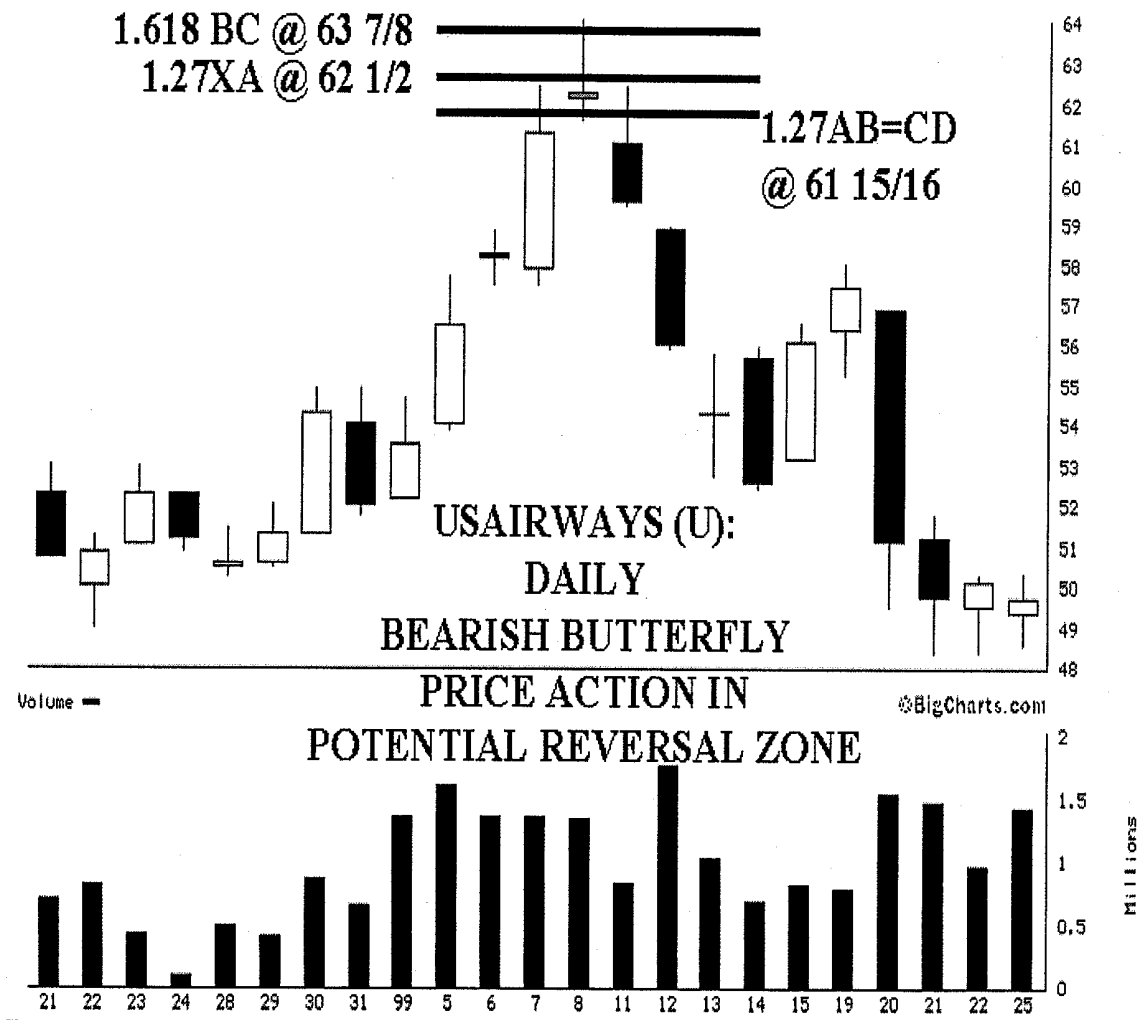

Despite this extreme price action, the next day tested the upper range of the potential reversal zone and began to decline. Also, the formation of the bearish candlestick - an inverse hammer - in this area indicated that the stock was having trouble continuing its rally. This is particularly significant

since the prior day was so bullish. When the price action does not continue higher – especially close higher than the day’s open – in a harmonic area, this should indicate that a reversal is at hand. The third day confirmed the reversal, as the stock gapped down on the open and sold off sharply.

The next chart shows that Apple Computer completed a clear bearish Butterfly in February 1999. There were several numbers that converged in the potential reversal zone. The 1.27 of the XA leg was projected at $47 \frac{7}{8}$, and the stock reversed approximately a $\frac{1}{2}$ point shy of the 1.27 projection of XA, topping out at $47 \frac{5}{16}$.

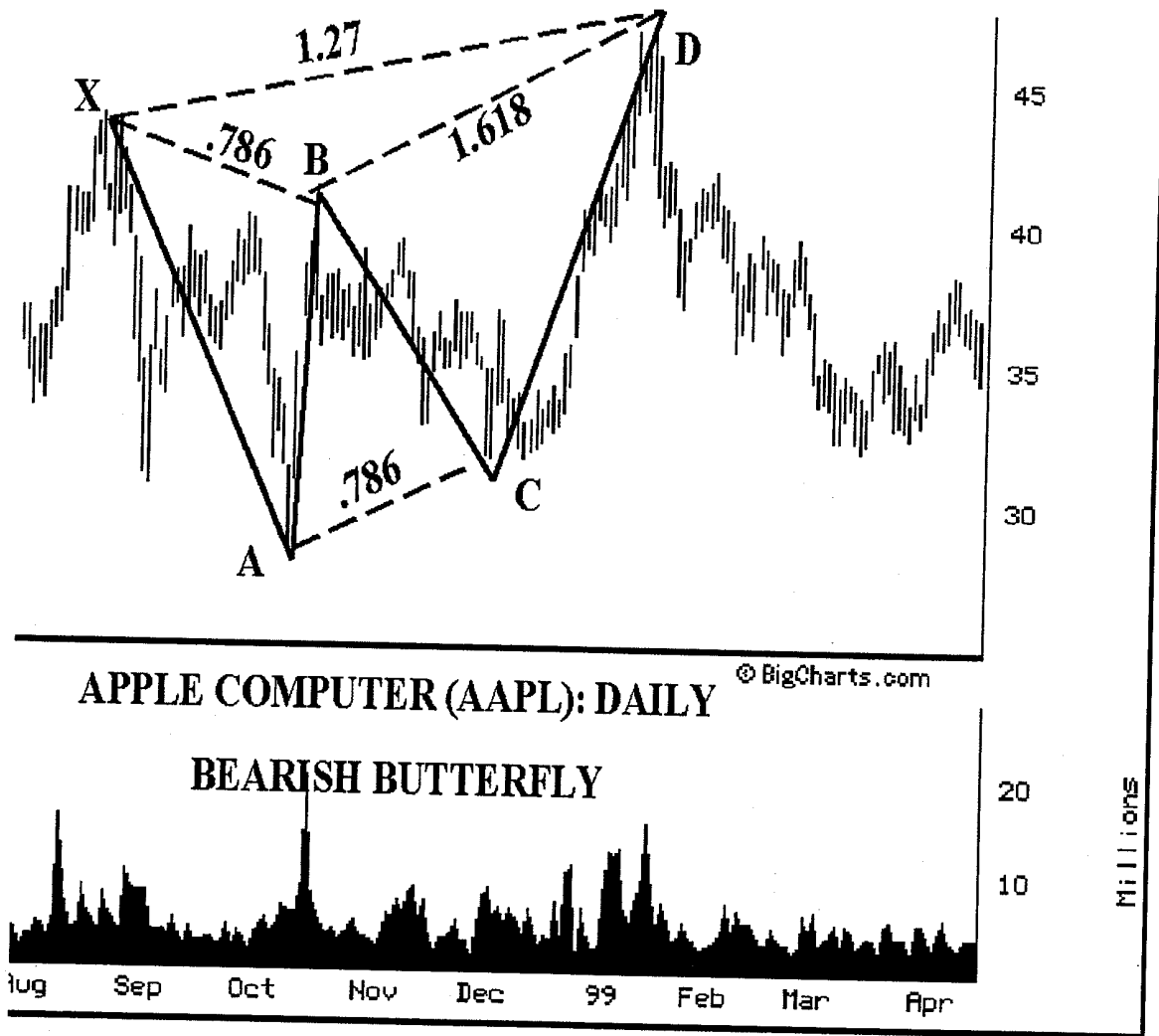

There were two other harmonic numbers that converged in this area that defined the potential reversal zone. The 1.618 projection of BC was calculated at $47 \frac{11}{16}$. The 1.27 alternate projection of the $AB=CD$ was calculated at $47 \frac{1}{4}$, which was $\frac{1}{16}$ of a point below the actual reversal.

This execution was a bit tricky, since the stock reversed a 1/2 point below the 1.27 projection of the XA leg. Although the stock reversed at the low end of the range, it did hit the potential reversal zone. I would have preferred to see the stock hit the 1.27 before executing a trade. But, this reversal was very close.

In this situation, if a stock seems to be reversing shy of a critical projection, you must wait for a clear reversal. Apple began to breakdown, as in the days following the reversal the stock started to make lower lows. Although this would have been a difficult execution, the pattern was so clear that it was a valid set-up.

This chart of Haliburton shows a clear bearish Butterfly pattern. The stock possessed three numbers in a tight potential reversal zone that yielded quite a reversal.

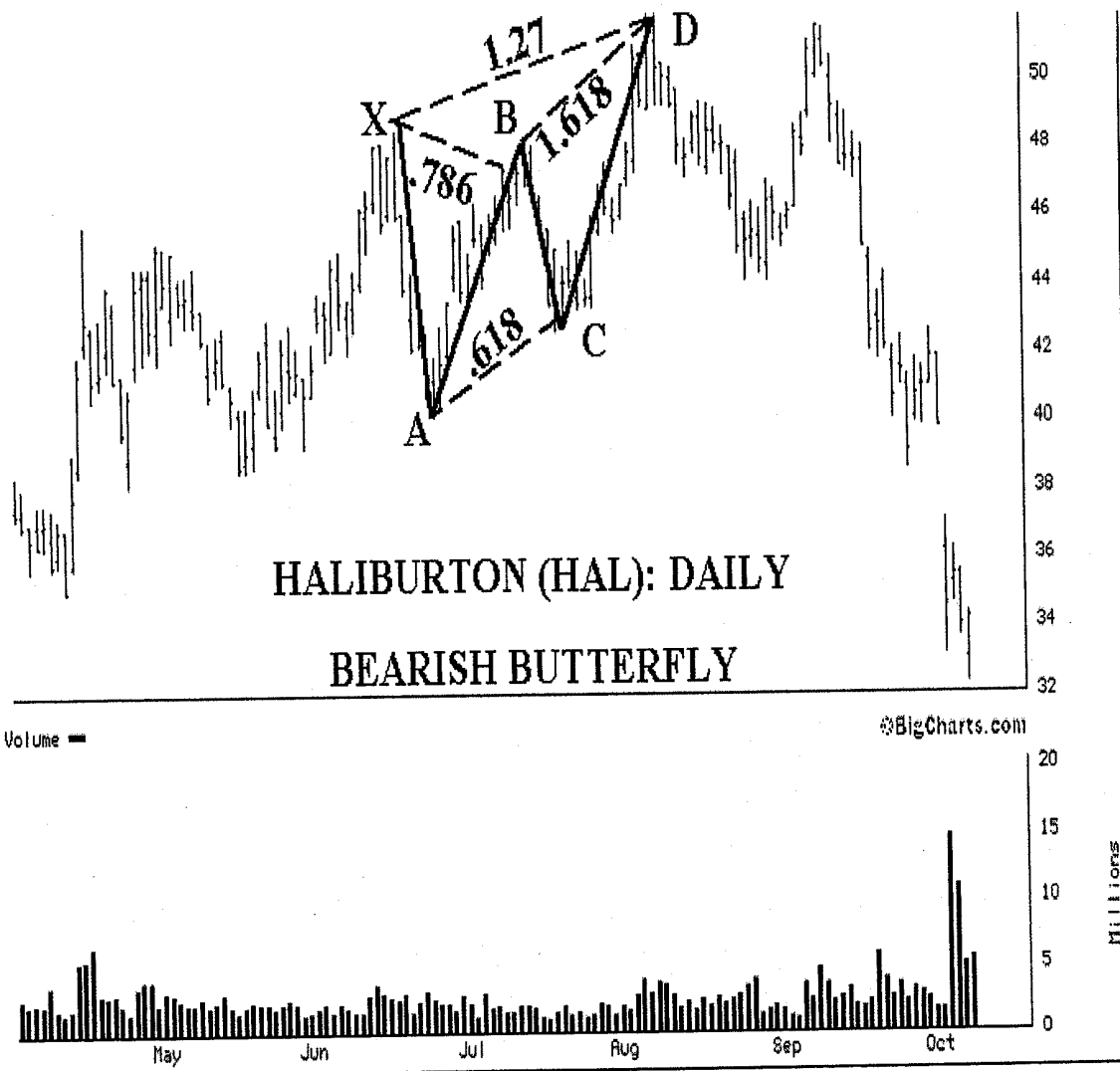

Haliburton formed a clear bearish Butterfly pattern that reversed ideally after hitting the potential reversal zone. This area possessed three numbers within less than a point of each other. The 1.27 of XA converged exactly at the same point as the equivalent $AB=CD$, which was calculated at $50 \frac{5}{8}$. The 1.618BC projection converged nicely with this area at $51 \frac{9}{16}$. The stock hit this tight range and reversed at $51 \frac{3}{4}$! This enlarged chart clearly shows the price action in the potential reversal zone.

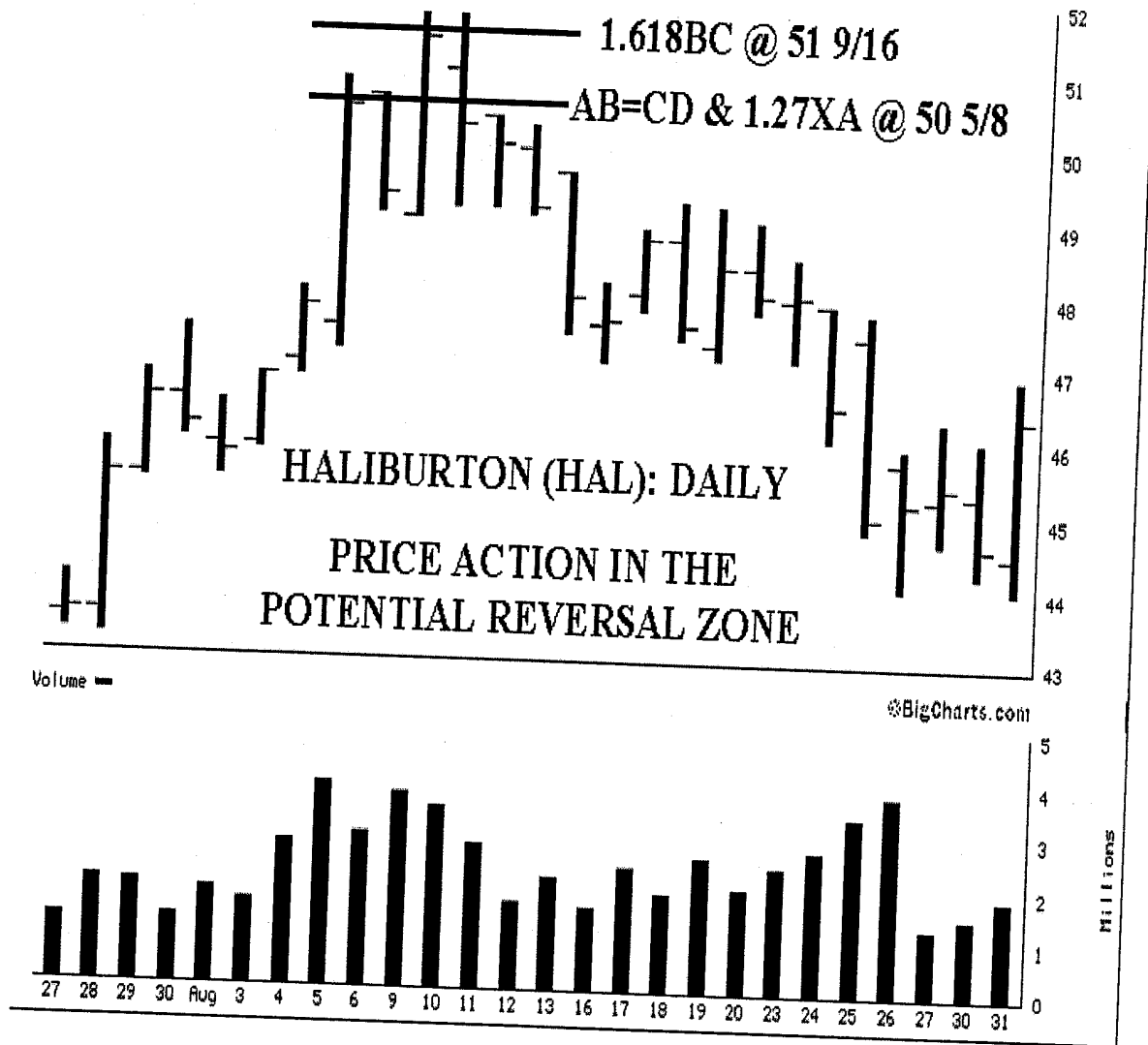

On the first day the stock hit the lower range of the potential reversal zone, the stock possessed a warning sign – an extreme price range. But, Haliburton could not blow out this area, as the stock reversed a few days later. So, even if you waited for a reversal to be confirmed, the set-up indicated an excellent area to be shorting the stock or taking profits.

Butterfly with a 1.618 Projection of XA

Since the Butterfly is a very powerful pattern, the predominant trend often exceeds the initial harmonic target at the 1.27. Although the 1.27 might be exceeded, it does not mean that the trade opportunity is to be avoided. When there is a clear pattern existing with other Fibonacci numbers existing beyond the 1.27, the 1.618 of the XA leg should be considered as the next potential target for a trade execution.

I have included a special section on the 1.618 Butterfly because it contains several elements that are different than the pattern with the 1.27 projection of XA. A 1.618 calculation of the XA leg will require the use of secondary numbers to project the BC leg. Also, the 1.618 Butterfly very frequently will require an alternate calculation of the AB=CD leg.

Bullish 1.618 Butterfly

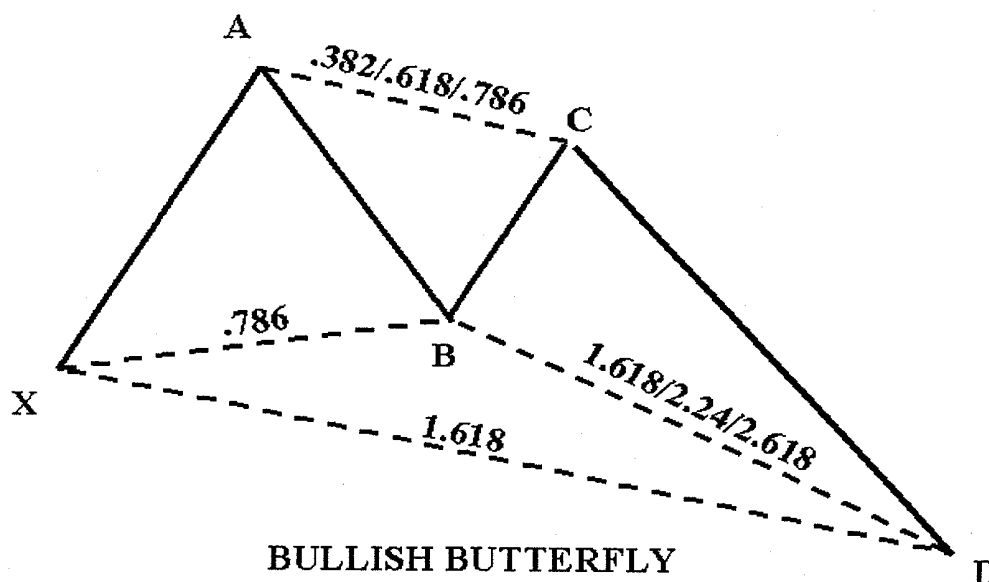

BULLISH BUTTERFLY

AB < CD

AD = 1.618XA

BUY AT D!

The bullish Butterfly pattern with a 1.618 projection is a very excellent trade set-up. Although this pattern frequently requires the use of secondary Fibonacci calculations, it still is a very harmonic pattern since several numbers converge in a specific area at point D.

The key in gauging this set-up is to observe the price action within the reversal zone. If the price action appears strong, as indicated by the warning signs such as tail closes, price gaps and extreme price ranges, the potential set-up is probably not a good trade opportunity. But, these signs will help to gauge the action around the reversal zone.

Sometimes, the price action will exceed the 1.27 decidedly, yet it will fail to hit the 1.618. In these instances, it is important to let the trade go. Such trades are difficult to gauge and they take a great deal of experience to possess the required "touch" to successfully execute. Let's look at some examples.

Mirage Resorts completed a nice bullish 1.618 Butterfly pattern in early 1999. The stock made a significant reversal around 13, in an area where several numbers converged. This potential reversal zone clearly supported the stock.

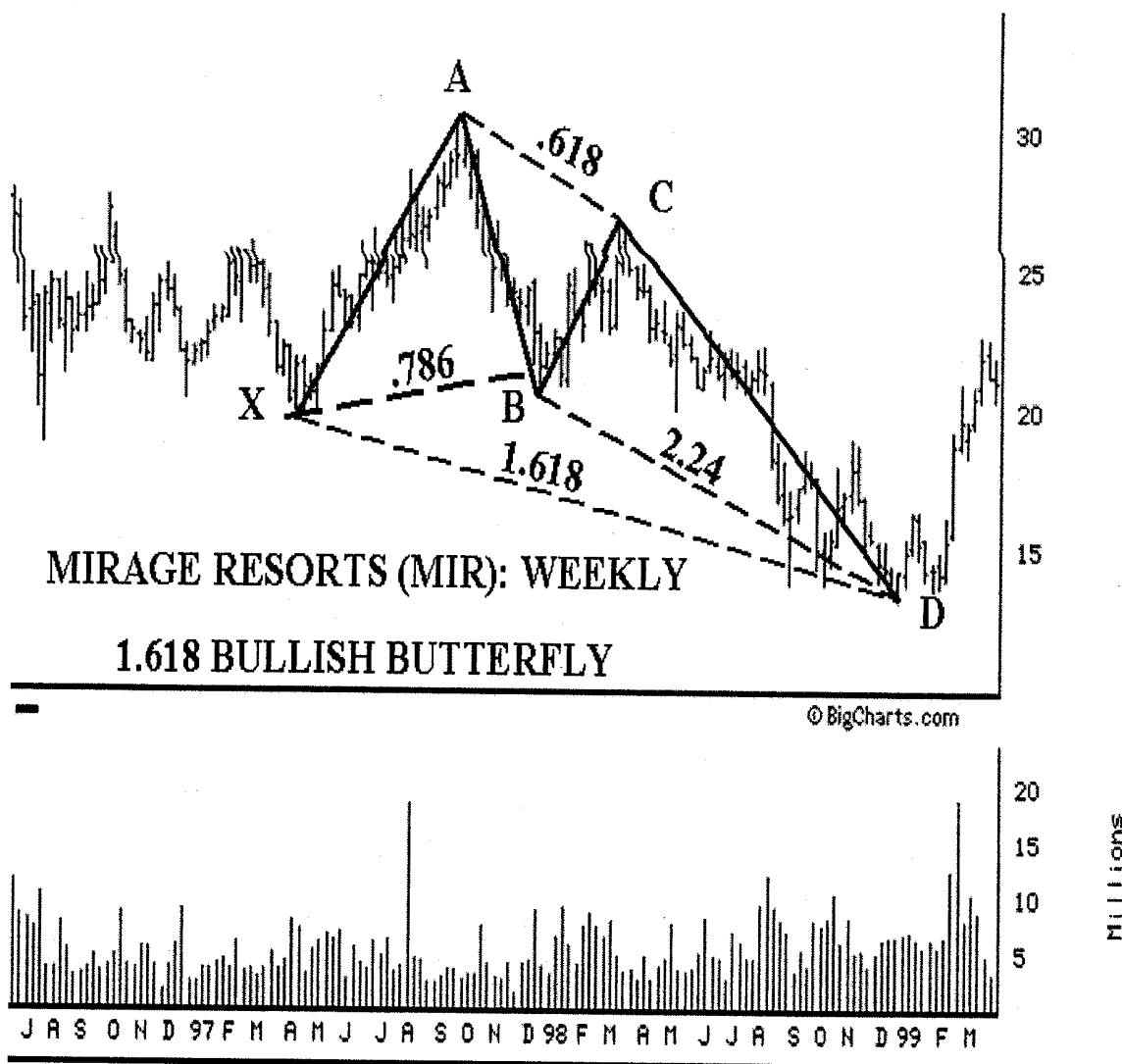

In fact, the stock reversed almost exactly off the 1.618. There were actually three important harmonic projections occurring right in this area. They were: 1. The 1.618 projection of the XA leg at 13 7/16; 2. The completion of the 1.27 alternative AB=CD pattern at 14 3/8; 3. The 2.24 projection of the BC leg at 12 3/4. The stock reversed at 13 3/16.

I've included an enlarged chart of the price action in the potential reversal zone. An interesting aspect of this reversal was the clear support that the stock experienced in this area. The stock stabilized just below 14 after selling off quite steadily for the prior year.

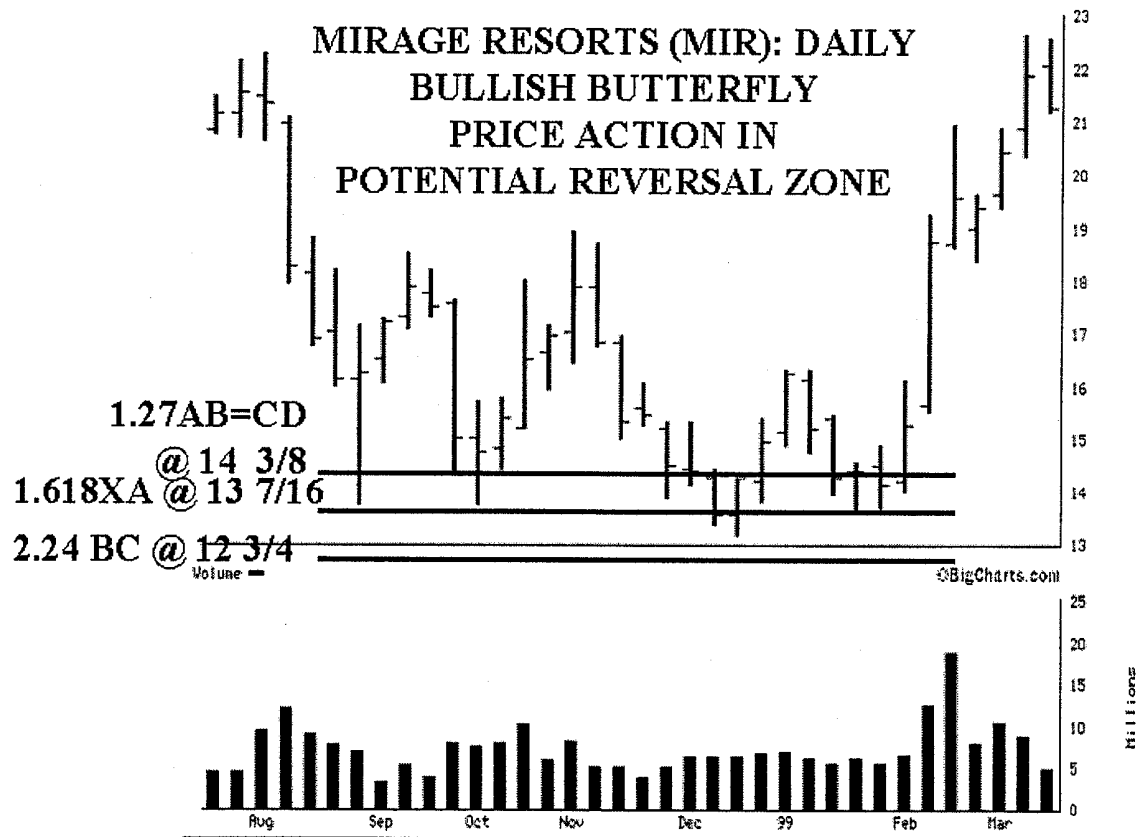

Another interesting aspect of this chart was that the stock started a new uptrend the day after hitting the most important calculation, the 1.618 of XA. Even if you waited for a clear reversal, you would have been still buying very close to the bottom.

A set-up that has all of these numbers converging in one area has a good chance of generating some degree of a reversal. Remember, the Butterfly pattern is a very strong signal. A reversal from such a pattern

usually results in a substantial move in the other direction. In this case, Mirage nearly doubled a few months after completing the pattern.

One other note about this set-up, you might be wondering: "How do you know whether to execute a Butterfly at the 1.27 or 1.618 of XA. My answer to this is: "read the signs." At the 1.27 around 17, Mirage was selling off very sharply, as indicated by the extreme price bar on the day that it hit this area. In fact, the day the stock hit the 1.27 projection of XA, it gapped down on the open.

These warning signs will frequently appear when a stock hits a potential set-up area. When they do appear, you must respect these signs. After letting the trade go at the 1.27, you could wait for another chance to buy at the 1.618, which was just below 14. The reversal zone proved to be a good buying opportunity, as the stock bounced on the day it hit the 1.618.

The next chart is a great example of the 1.618 Butterfly. Pepsi formed a fantastic pattern that yielded quite a reversal. The stock bounced exactly off the 1.618 projection of XA, which was calculated at 27 9/16. The 2.618 of the BC leg was also close to this number, as it was projected at 27 3/4.

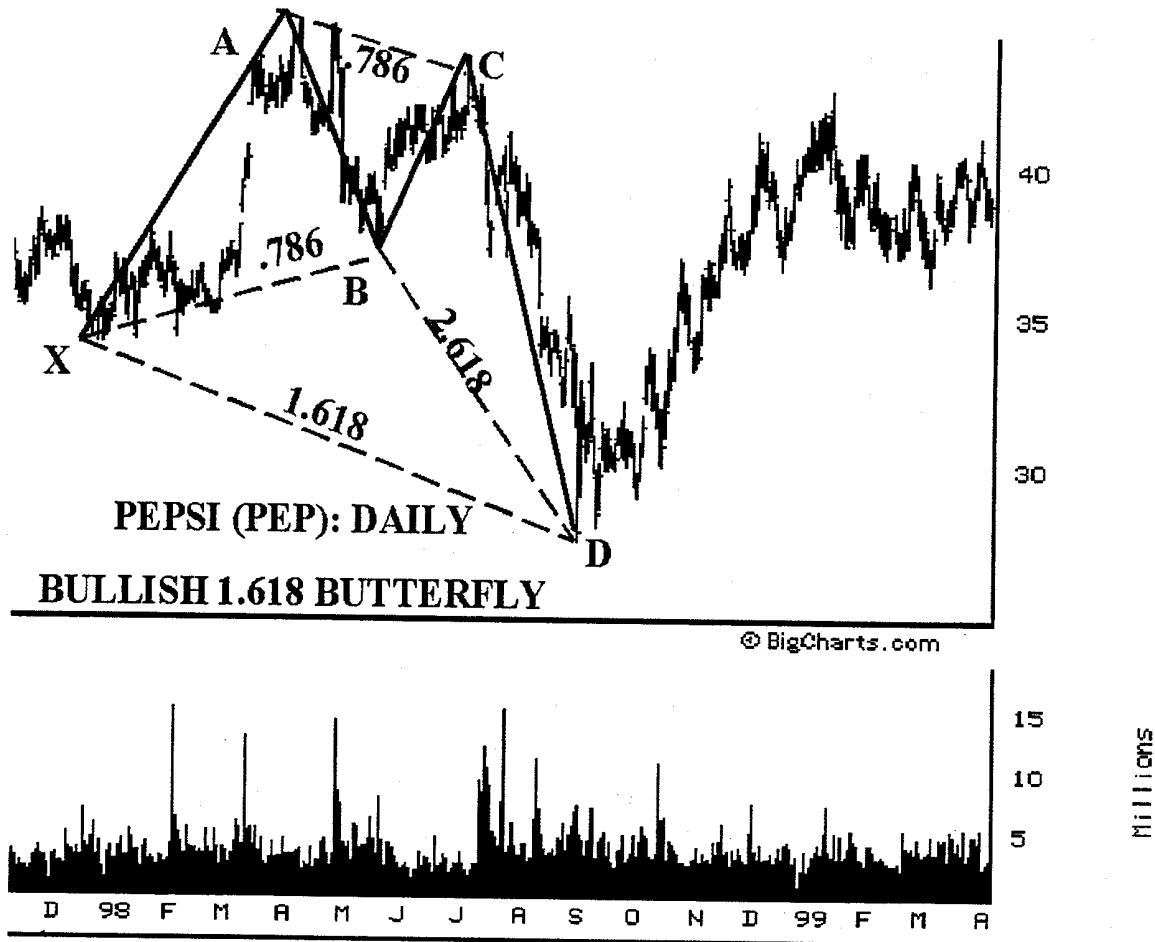

Although the price action was extreme on this day, the stock did clearly reverse. If you waited a day, the stock confirmed the reversal with a few days after the stock bottomed. Pepsi climbed higher in the following weeks and never broke the low point established on the reversal day.

Bearish 1.618 Butterfly

The bearish 1.618 Butterfly is a powerful pattern. Since the final leg can be extended, I recommend waiting for the 1.618XA leg to be reached at a minimum before executing the trade. When the price action is volatile, it is prudent to wait for a clear reversal price bar.

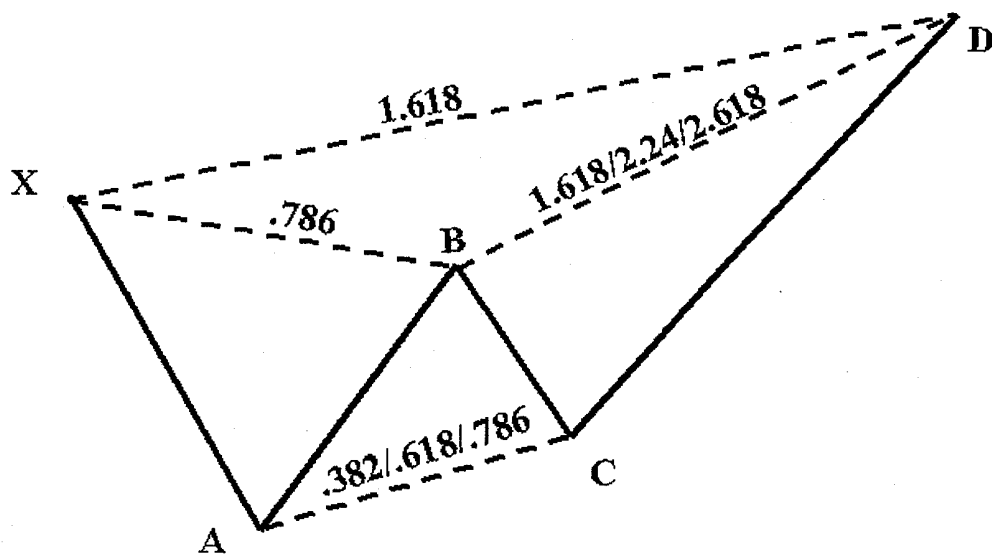

BEARISH BUTTERFLY

$$AB < CD$$

$$AD = 1.618XA$$

SELL AT D!

The 1.618 bearish Butterfly is a great set-up when a clear geometric pattern exists. Like the bullish 1.618 pattern, the bearish Butterfly will require that you calculate some projections with the secondary numbers. Usually, the BC leg requires at least a 2.24 calculation. Also, the alternate projection for the AB=CD pattern – either a 1.27 or 1.618 of the AB leg - occurs most of the time. Let's look at an example.

The following weekly chart of Dupont illustrates the significance of the 1.618 bearish Butterfly as a powerful reversal signal. Dupont rallied sharply throughout most of 1998. The stock completed a clear bearish Butterfly in May 1998 and lost 40% of its value over the following nine months.

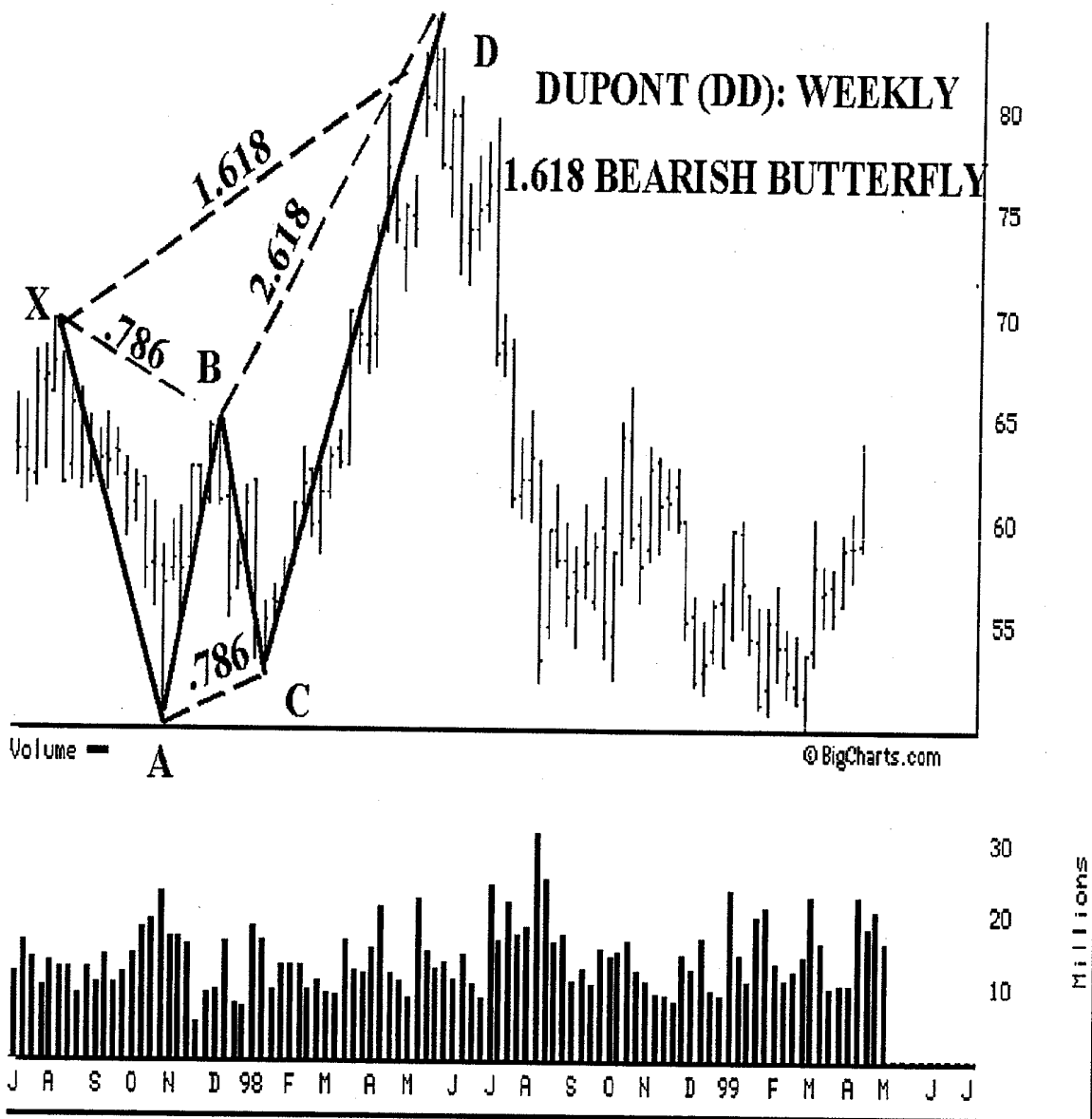

The stock formed a nice Butterfly pattern and reversed after hitting the 1.618 projection of the XA leg. In this area, there were two harmonic projections that defined the potential reversal zone. The 1.618 was at 81 13/16, while the 2.618 projection of BC was at 84.8125. The stock reversed in this area at 84 7/16.

When an obvious pattern like this develops, you must be prepared to sell. At the first opportunity to sell at the 1.27 projection of XA around 75, the stock experienced a strong rally, as evidenced by the extreme price ranges. Although the stock did sell off a few points after hitting the 1.27 projection, the 1.618 between 82 and 83 provided a better selling opportunity.

The following enlarged chart clearly illustrates the reversal in the potential reversal zone. Although the price action formed a bearish price bar on the first week it hit this area, the stock was extremely strong due to the gap up on the week. So, you probably should have waited for a clear reversal sign.

Two weeks later, Dupont started to reverse. Within the next several weeks the stock clearly broke down, especially since it made new weekly lows. This reversal was very significant because the pattern was so clear, and the stock lost over 30 points during the next several weeks.

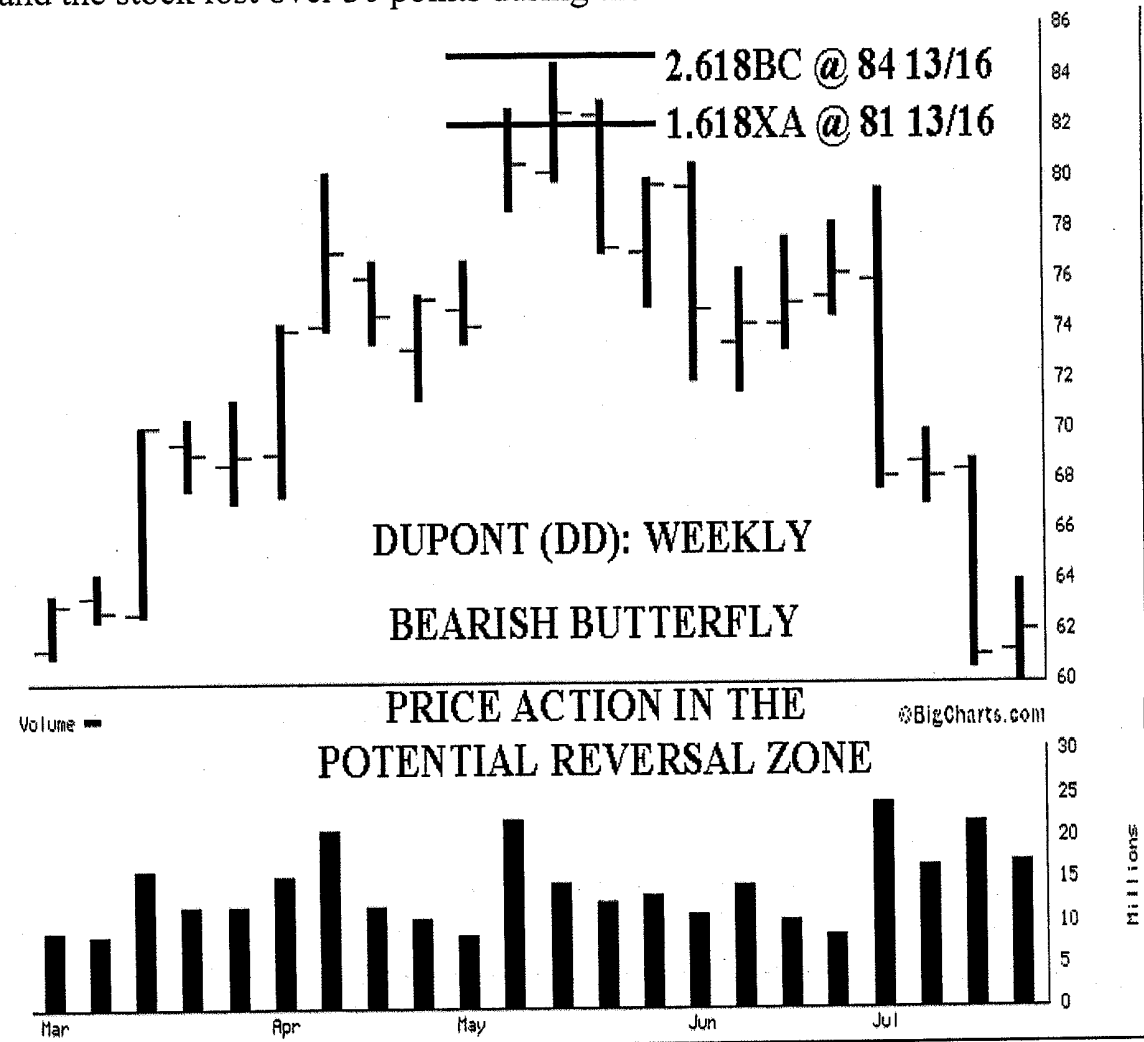

The next weekly chart of Nike is an excellent example of a 1.618 bearish Butterfly. The stock formed a clear pattern that reversed almost exactly off the projection of the 1.618 XA leg.

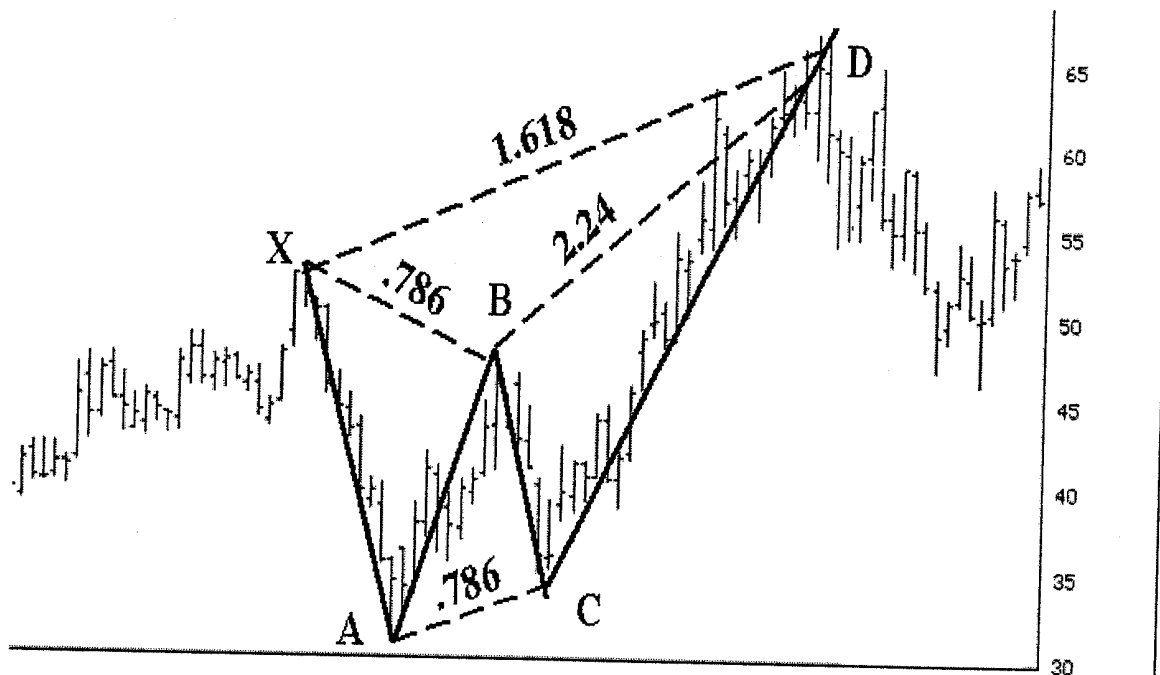

NIKE (NKE): WEEKLY

©BigCharts.com

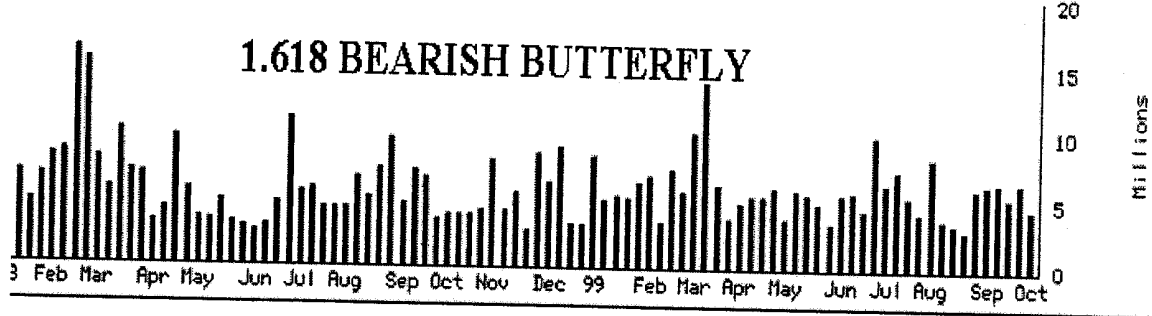

The potential reversal zone possessed two numbers between $63 \frac{5}{8}$ and $66 \frac{1}{8}$ for an excellent opportunity to take profits or enter a short position. The 1.618XA projection was calculated at $66 \frac{1}{8}$, while the 2.24 of the BC leg complemented this area at $63 \frac{5}{8}$. The stock hit this area and reversed ideally. Nike topped at $66 \frac{15}{16}$ and started to break down in the weeks following the reversal.

As the previous examples demonstrate, the 1.618 projection of the XA leg is the most critical number in this set-up. But, it is not uncommon for the price action to hit the other harmonic calculations. Therefore, it is imperative to focus on the entire area to determine the validity of the trade.

Butterfly Summary

Similar to the Gartley, the Butterfly is a pattern that occurs frequently. However, there are several key differences that clearly define the pattern. The most important difference is the completion point of D beyond the initial starting point X. Again, the 1.27 of XA signifies a key reversal area for the completion of the pattern at point D. I consider the XA projection to be the most important number within the potential reversal zone. In addition, I recommend waiting for the price action to hit the 1.27 of the XA leg before executing a trade. If the pattern does not hit the 1.27, I will let it go and look to the next area at the 1.618 projection.

Another distinguishing element is the reversal point of B. Remember, in a Butterfly the retracement of the XA leg should be .786, as compared with a Gartley where the reversal at point B is a .618 retracement. When the AB leg reverses off the .786 retracement of XA, I know that a potential Butterfly is "in the works." The .786 is extremely useful in identifying and validating an ideal Butterfly pattern.

The 1.618 of the BC leg is useful in defining the completion of the Butterfly. An ideal set-up will include a 1.618 price move from the BC leg that converges with a 1.27 price move from the XA leg. In a 1.618 Butterfly, it is important to use the extreme projections of 2.24 or 2.618 for the BC leg to further clarify the potential reversal zone. Remember, the 1.618 signals a state of extreme price action. When this occurs, I will wait for this price point to be exceeded before executing a trade. However, when the price action exceeds the 1.618 point, I know that I am close to executing the trade.

Another calculation that defines the potential reversal zone is the completion point of $AB=CD$. As I mentioned before, the Butterfly pattern often will contain a CD leg that usually becomes over-extended. Therefore, it is very important to calculate the 1.27 and 1.618 alternate projections of the $AB=CD$ pattern. These calculations should be utilized to gauge the price action and serve to complement the more critical harmonic numbers. I do not use these alternate projections as execution points unless other significant calculations are present.

The Butterfly is a very powerful pattern. The price action can be very volatile, especially in 1.618 Butterfly patterns. So, it can be advantageous to wait for reversal confirmation. Although this will delay a trade execution, valid reversals off the pattern will put you in stocks at critical turning points that can yield substantial profits.

16

Three-Drives

Although the Three Drives pattern is not as complex as the other patterns, it is as significant in determining key reversal zones. One of the most important elements of a Three Drives pattern is the symmetrical price thrusts. The Three Drives pattern should be easy to identify, as it should literally stick out at you. The creation of the first two drives should be unique to prior price action and be very distinct. After the initial two thrusts have been identified, the potential reversal zone can be easily calculated.

The drives should occur at symmetrical time sequences. For example, if the time period between the first two drives is five price bars, the third drive should complete at the next fifth bar. The time periods do not have to be exact for a valid reversal signal.

Although the symmetry of the price thrusts is the key to this pattern, the price action does not always reverse exactly at the Fibonacci projections. Once a stock has entered into the potential reversal zone, it is important to closely examine the price action and respect any warning signs. The Fibonacci projections will indicate the general area for the trade execution. I believe that valid reversals usually bounce shortly after hitting the Fibonacci projection at the third drive. In general, as the stock is completing third drive, the price action can be quite extreme. So, it is wise to exercise caution before executing a trade. Sometimes, it is better to wait a few price bars for signs of a clear reversal confirmation.

The Three Drives pattern occurs less frequently than the other patterns. But, it is probably one of the easiest to identify. The trade execution is the most difficult aspect, since the price action can be volatile. But, it is a significant signal because reversals that occur following the completion of the pattern are usually quite strong.

Bullish Three Drives

A bullish Three Drives pattern is one of the easiest patterns to identify. As a stock is selling off, the price action usually will form two distinct thrusts, which should indicate the potential for a reversal at the next thrust. Let's look at the illustration.

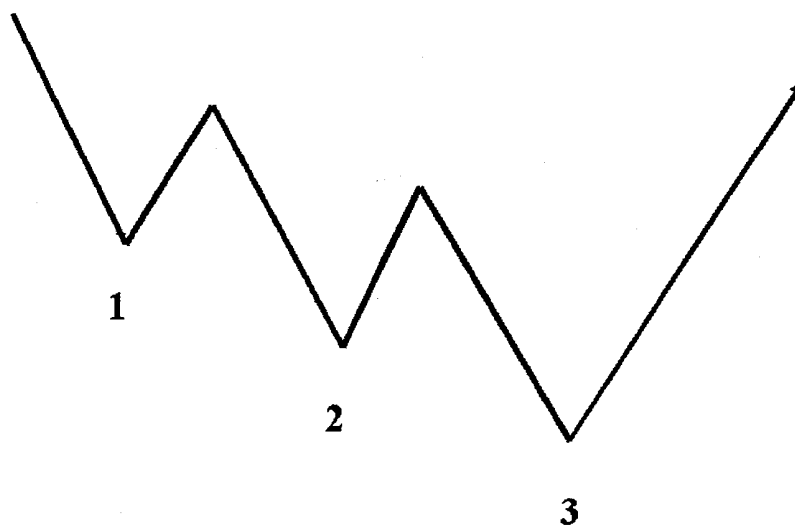

BULLISH THREE DRIVES: BUY AT 3!

The pattern should form the same framework as the illustration demonstrates. The bullish Three Drives should possess distinct thrusts that provide a clear buying opportunity at the third drive. Although this set-up seems simplistic, this pattern frequently yields significant reversals.

Bullish Three Drives Stop Loss

The stop loss limit for a Three Drives pattern is similar to a Butterfly. Since it usually occurs in price extremes, there is no prior price to gauge the stop loss. So, it is important to focus on the individual price bars at the potential completion point.

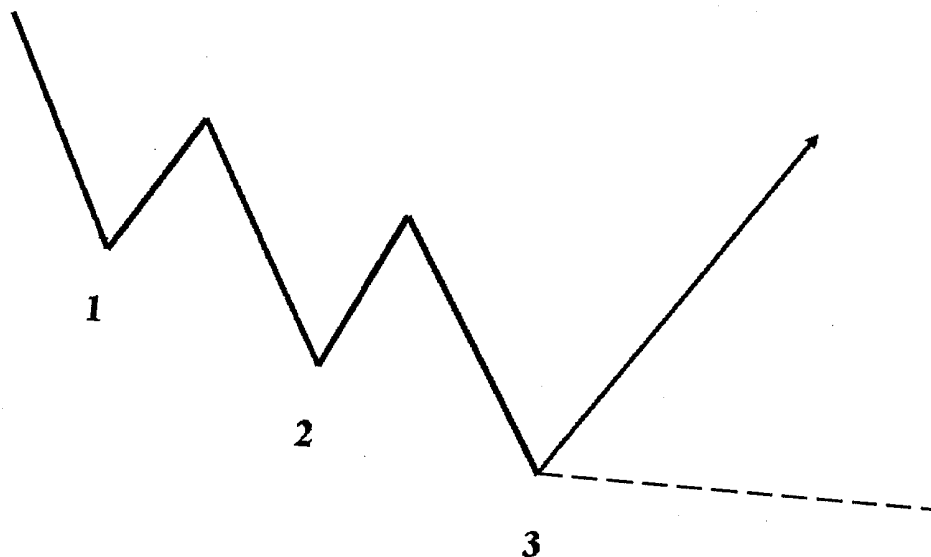

BULLISH THREE DRIVES WITH STOP LOSS: COVER BELOW 3!

The stop loss for the Three Drives pattern is fairly simple. Usually, the stop loss should be placed just beyond the third drive. Since the pattern is a very clear set-up, the completion of the third drive should stick out at you in the same manner as the other two drives. If the pattern and reversal are valid, the ultimate point of the third drive should not be violated, once it is established. It is important to note that a close beyond the Three Drives pattern is very significant event. In my opinion, a close below a Three Drives set-up invalidates the pattern.

Ideal Bullish Three Drives

The ideal bullish Three Drives pattern should possess Fibonacci retracements and projections at each thrust. However, these numbers will usually not be exact. If they are within a point or two, I consider the pattern to be valid. Again, the important aspect of this chart is the general symmetry.

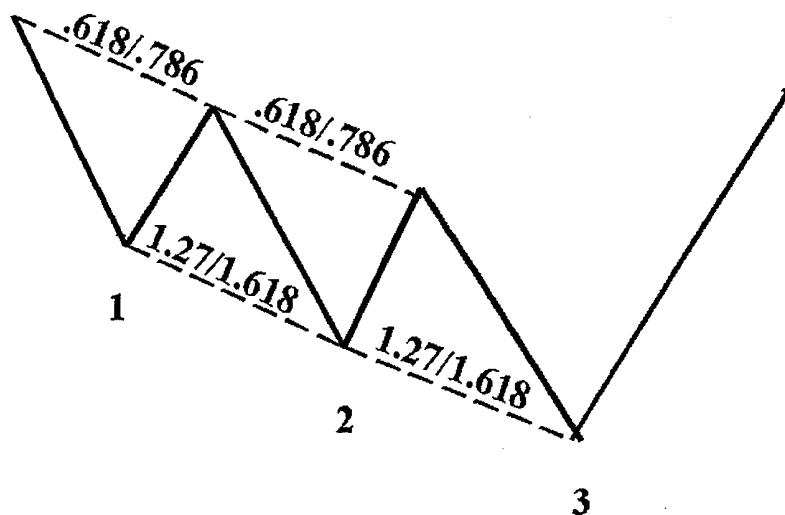

BULLISH THREE DRIVES: BUY AT 3!

Sometimes, the third thrust will fail to hit the projected number exactly. In these situations, it is important to wait for a clear reversal signal. Waiting for clear confirmation can be effective because it can help validate reversals off this pattern and prevent a flawed execution.

The first example shows how Home Depot completed a very clear bullish Three Drives pattern. The three drives were very symmetrical in price and time. Each thrust completed at approximately the 1.27 of the prior drive. Also, each drive developed over approximately one month, although the third thrust was bit extended. Despite the extension of the third drive, this pattern does stick out at you.

HOME DEPOT (HD): DAILY

BULLISH THREE DRIVES

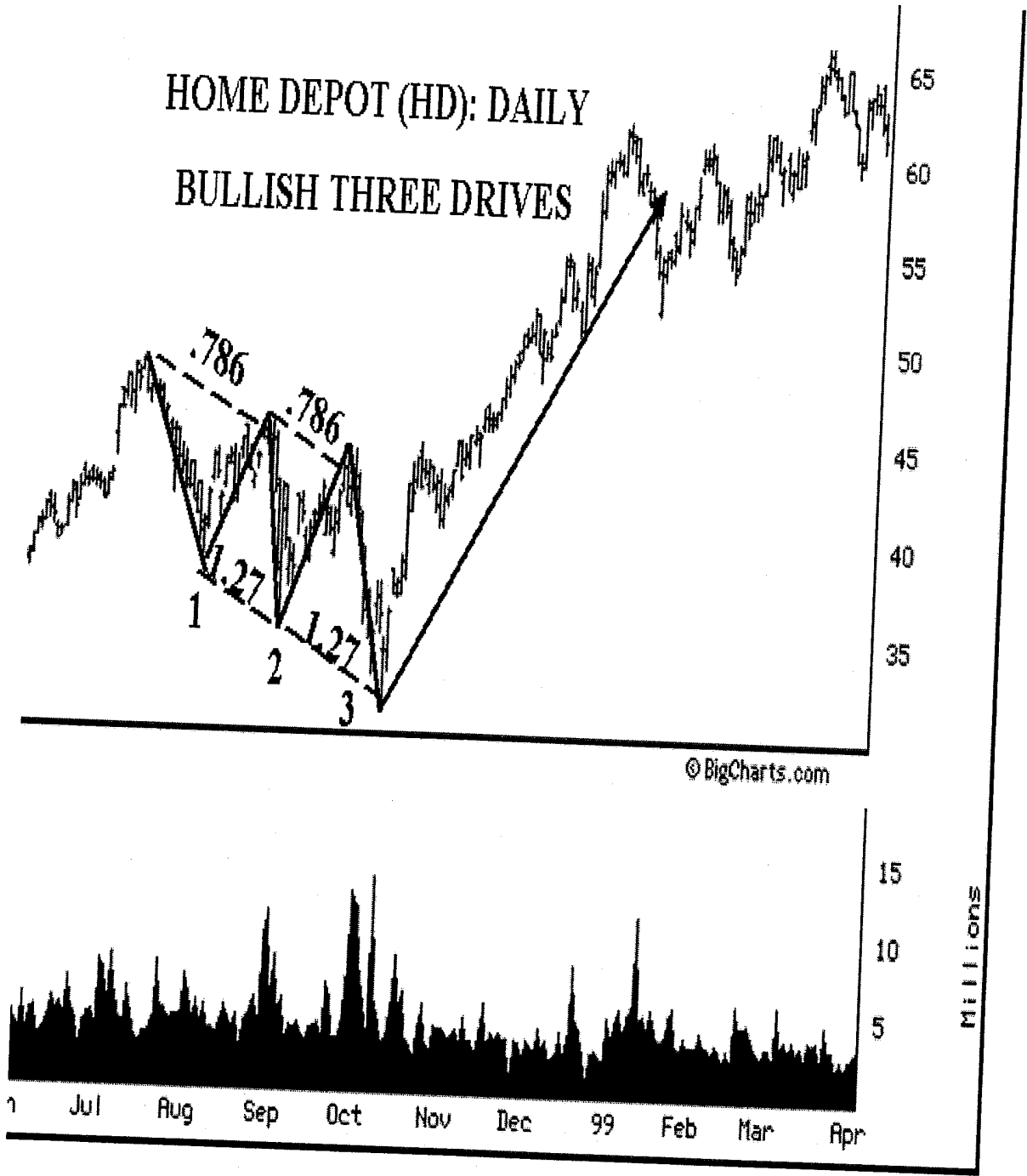

This is a very ideal set-up for a bullish Three Drives pattern. The price thrusts formed quite symmetrically. Also, each down thrust reversed at the 1.27 projection. The third drive exceeded the 1.27 projection slightly. It was calculated at $32 \frac{11}{16}$ and the Home Depot reversed at $31 \frac{5}{8}$.

It is important to note that the stock reversed on the same day it hit the 1.27 projection. Although the price action was somewhat extreme on this day, the stock did indicate that the harmonic area was yielding a valid reversal. I've included the following enlarged candlestick chart of the pattern that clearly shows the stock reversing off the 1.27 projection.

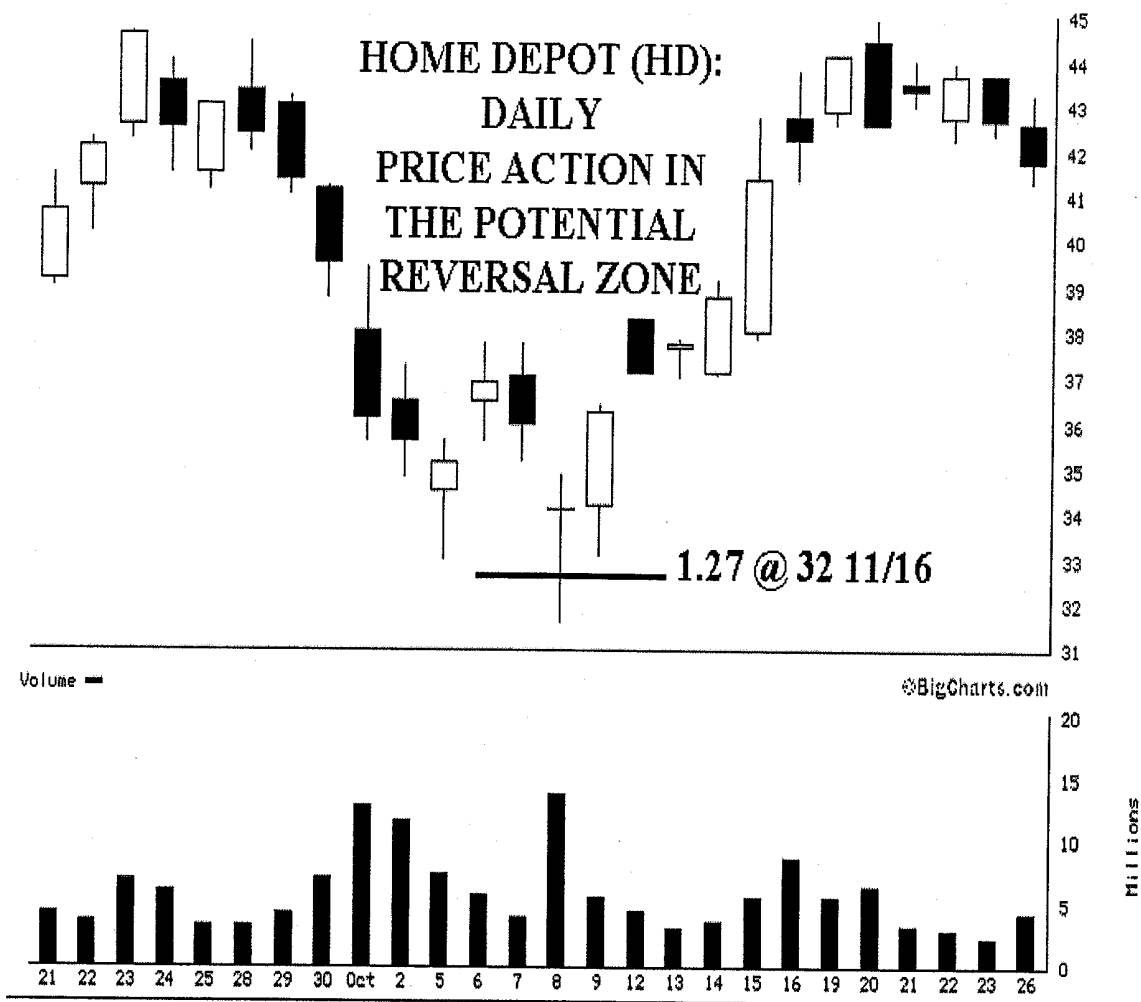

As you can see, the stock experienced two warning signs on the day it hit the potential reversal zone. On this day, it gapped down on the open and possessed an extreme price range. Due to these warning signs, you might have waited a day to enter the trade. The next day the stock clearly was heading higher, as the stock closed above the previous day's high and closed near the high of the day. Although waiting an extra day would have put you into Home Depot a few points above the low, the pattern still accurately indicated a significant bottom.

Despite these signals, the stock bounced back quite nicely, as it ended the day unchanged and formed a doji price bar. The doji candlestick is an excellent reversal sign after the completion of the Three Drives pattern. In this case, the stock formed doji and possessed a nice bullish continuation, as Home Depot rallied for several days without breaking the prior day's low. All of these indications validated the reversal. Therefore, when a Three Drives pattern is observed, you should prepare for a significant reversal. This pattern in Home Depot resulted in a 100% move in the following six months.

The next chart of Gateway Computer shows a very nice geometric pattern. This is another good chart to study because it exemplifies the symmetry of an ideal pattern, as each thrust was almost exactly a month.

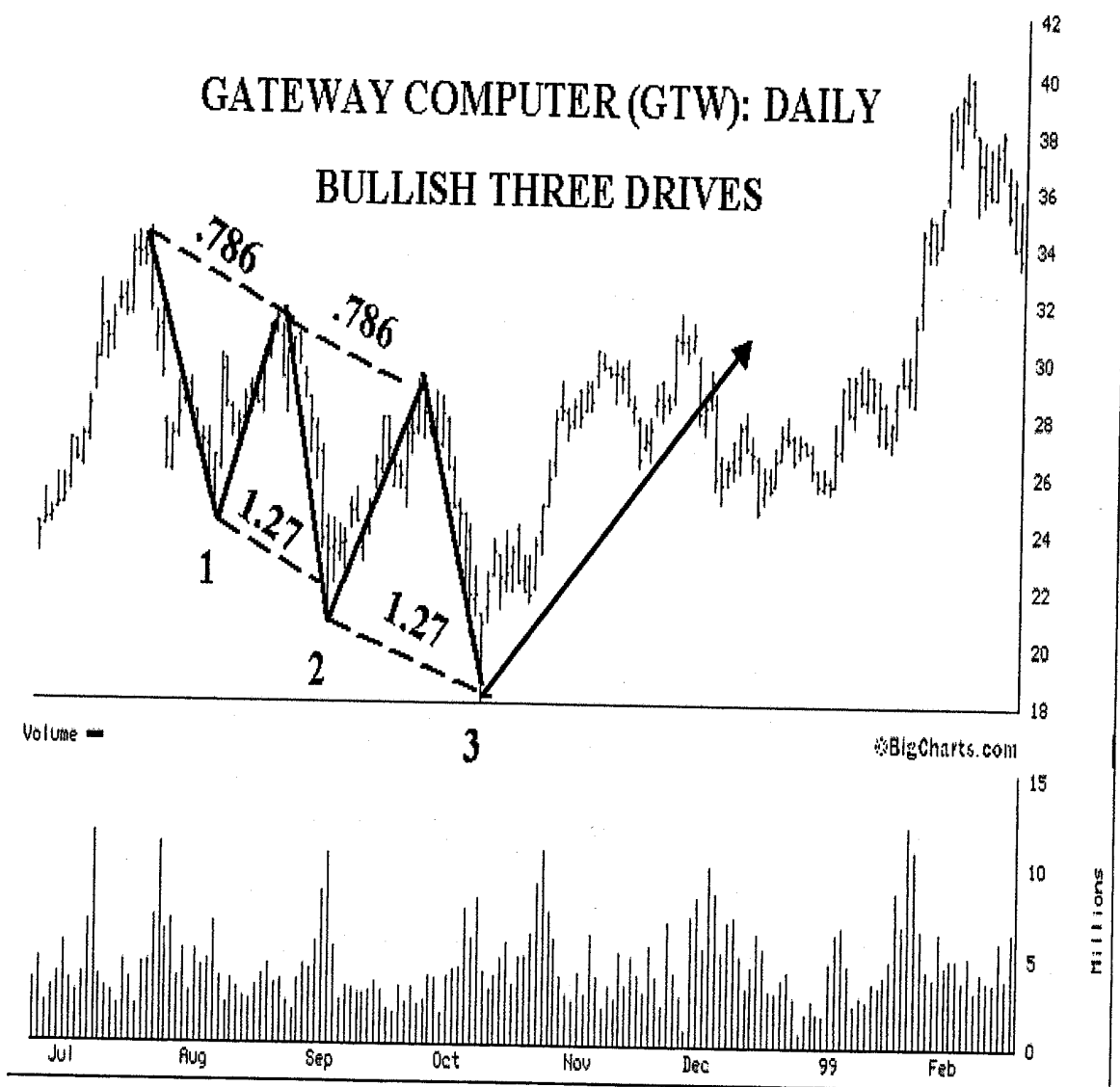

Gateway formed a great bullish Three Drives that reversed at the 1.27 projection. The third drive was projected to complete at 18 7/8. The stock hit 18 1/16 and bounced. Although the stock exceeded the 1.27 slightly, the stock did reverse on the same day it hit this projection.

This is a great example to study because the three drives were very symmetrical. Each drive made its low approximately at the beginning of their respective month. Also, each drive reversed on the same day it hit the 1.27 projection. On the third drive, the stock experienced two warning signs, a price gap and an extreme price range, the day it hit the 1.27 projection. Due to the warning signs, you might have waited to execute your trade. But, the stock formed a very nice hammer after hitting the projection. Furthermore, the following day confirmed the reversal, as the stock finished well above the prior day's action. I have included this enlarged candlestick chart that clearly shows the third drive reversing off the 1.27 projection.

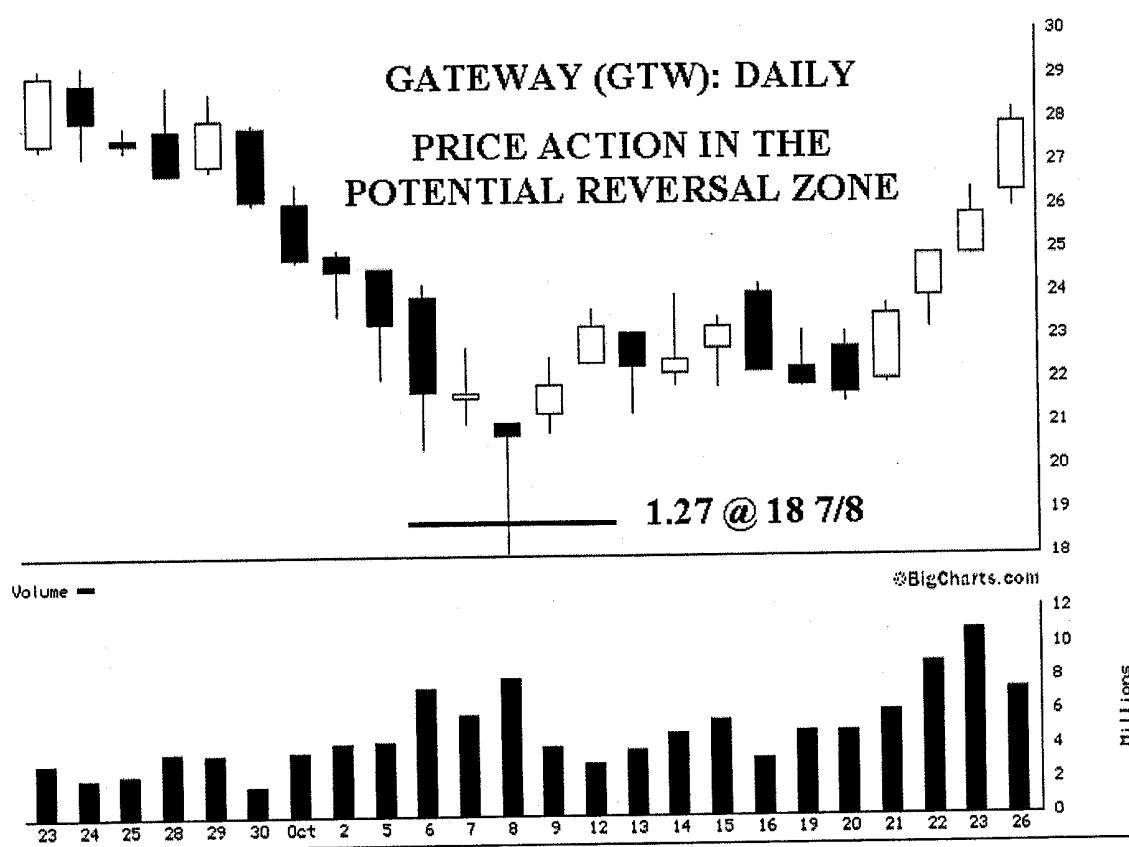

Candlestick charts can illustrate reversals in a Three Drives pattern very clearly. In Gateway's case, the hammer at the 1.27 projection of the third drive provided significant evidence of a valid reversal, despite the warning sign. After completing the pattern, the stock bounced sharply and

started a clear uptrend. Gateway repeatedly closed higher and within a few weeks the stock rallied substantially.

The bullish Three Drives frequently indicates where potential reversals can develop. The pattern should be clear, as these examples have demonstrated. The pattern should also possess a nice symmetry in both time and distance. It is important to not force the pattern. If the pattern is not obvious, it is probably not a valid signal. However, clear patterns like these prior examples do materialize frequently, and they will really stick out on a price chart. Therefore, it is important to study these previous examples, as ideal set-ups for future opportunities.

Bearish Three Drives

In the same manner as the bullish pattern, the bearish Three Drives is a very clear pattern. When a stock forms three distinct price thrusts, especially after an extended rally, this pattern will indicate a potential reversal at hand. Let's look at the illustration.

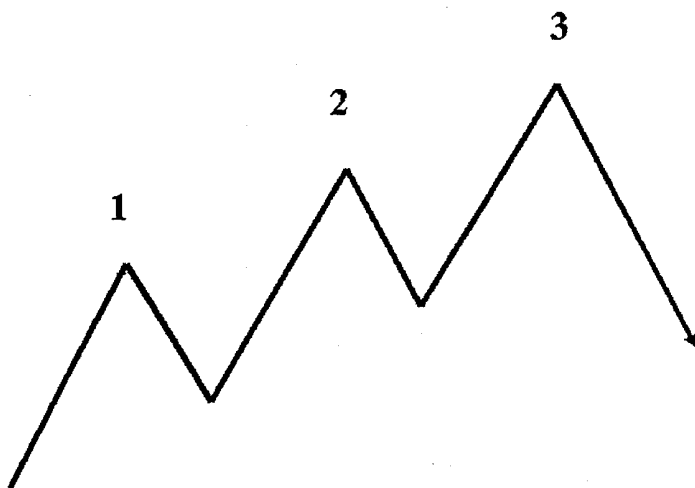

BEARISH THREE DRIVES: SELL AT 3!

This seems like a very simple pattern. However, stocks frequently form this pattern that signals an important reversal. The pattern should stick out at you in the same manner as the diagram illustrates.

Bearish Three Drives Stop Loss

The bearish stop loss is a very subjective limit. Since the Three Drives is such a clear pattern, any substantial breakout above the third drive would negate the pattern.

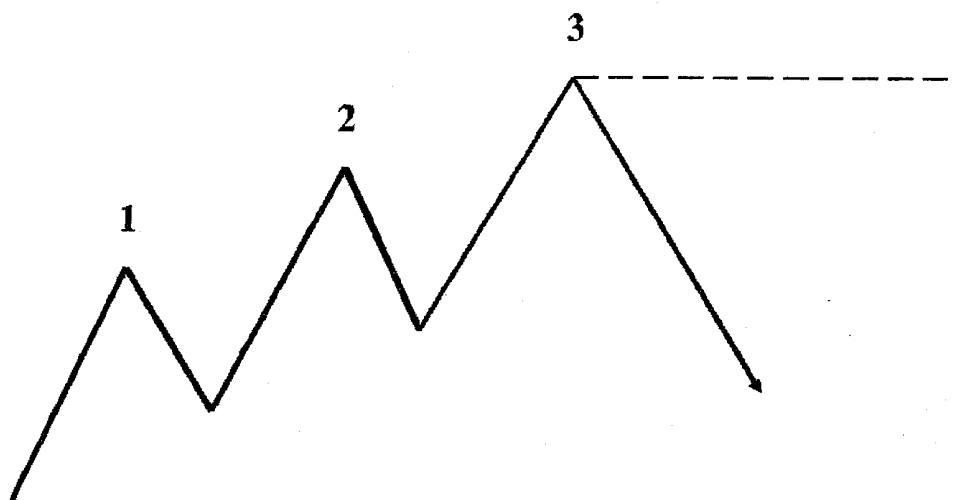

BEARISH THREE DRIVES WITH STOP LOSS:

COVER ABOVE 3!

As with most reversals, if the pattern is valid, the reversal should occur relatively quickly. Once the three drives are identified, the potential reversal zone should stop the prevalent trend and the price action should not exceed this area.

Ideal Bearish Three Drives

Similar to the bullish pattern, the bearish Three Drives will be a very clear pattern. In fact, I believe that bearish set-ups occur more frequently and are often more symmetrical. Let's look at the following illustration.

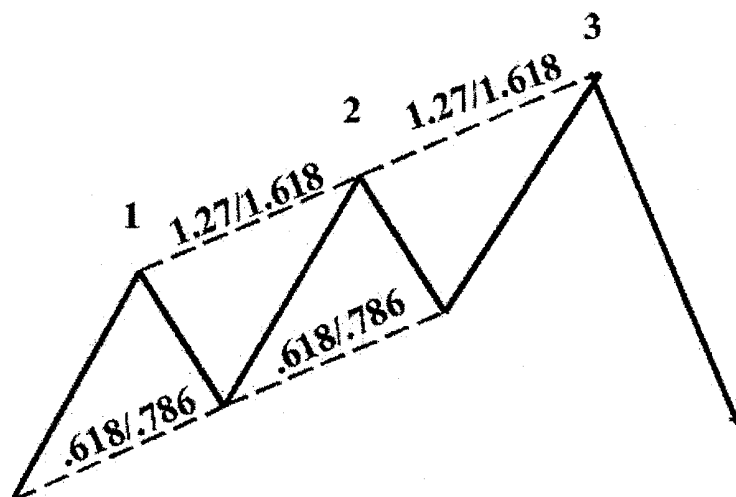

BEARISH THREE DRIVES: SELL AT 3!

In my opinion, a bearish Three Drives seems to stick out even more than a bullish pattern. Perhaps, a stock that is rallying strongly is more appealing than one that is selling off? Whatever the reason, the bearish pattern should be very clear. The first two thrusts will form on a price chart and then you will calculate the completion of the third thrust. Let's look at an example.

The following chart of Rambus Software shows an ideal Three Drives pattern that was very symmetrical. Each thrust completed at the 1.27 projection. In fact, the third drive reversed after exceeding the 1.27 projection by less than a point. The potential reversal zone for this set-up was at the 1.27 projection of the prior drive calculated at 109 1/4. If you were looking to short this stock, when it reached 109 you should have been preparing to sell.

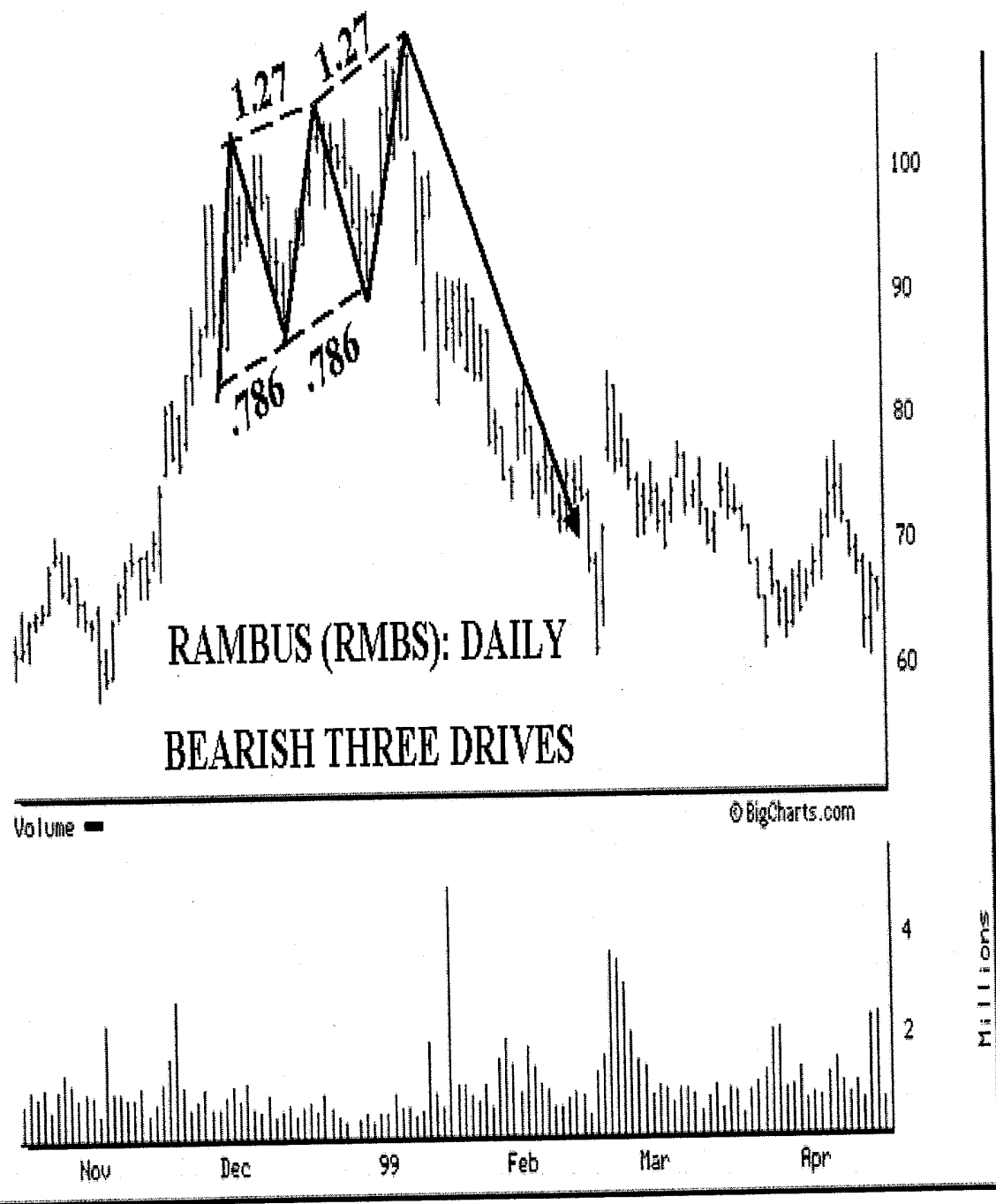

In this situation, I would not have been surprised to see the stock rally through the 1.27 projection and top slightly above 110. Sometimes, stocks will reverse off nice, round numbers such as 100, 110, etc. Rambus did almost hit 110 exactly, as the stock topped out at 109 15/16. The stock sold

off sharply in the following few days, confirming a new downtrend. Within the following few months, the stock was almost cut in half!

The stock did show clear reversal signs at the 1.27 projection, as is illustrated in the following enlarged chart. After the pattern was complete, the price bars turned very bearish. Also, the stock gapped down in the next several days after completing the reversal.

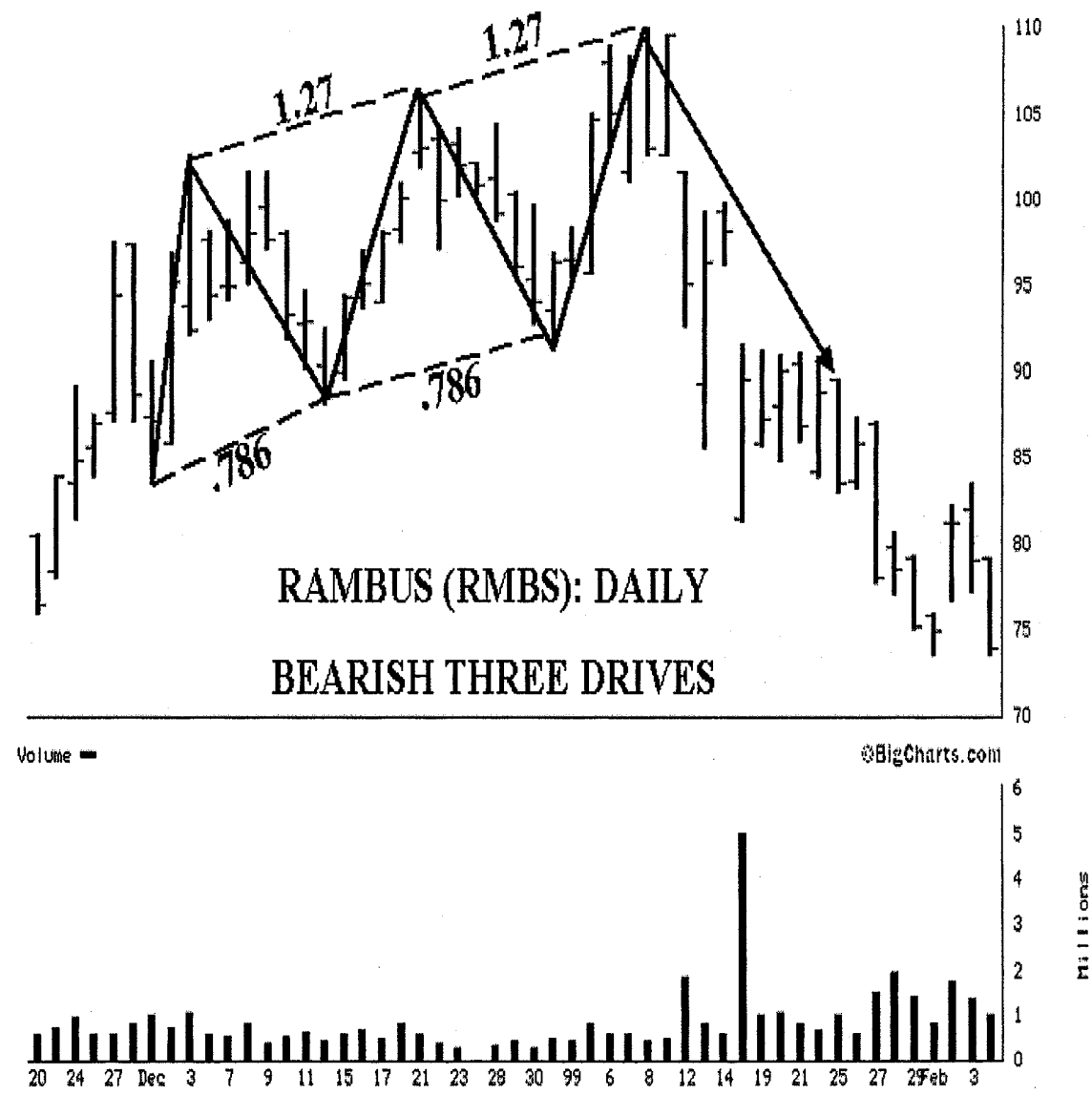

Such bearish price patterns following a powerful signal like the bearish Three Drives indicate that a serious reversal is at hand. It is important to study this example because it really demonstrates the dynamics of the pattern.

The next chart is a good example of an obvious pattern. Internet America formed a clear Three Drives pattern on this hourly chart. I included this chart because it represents the character of the pattern. The three price thrusts clearly stick out.

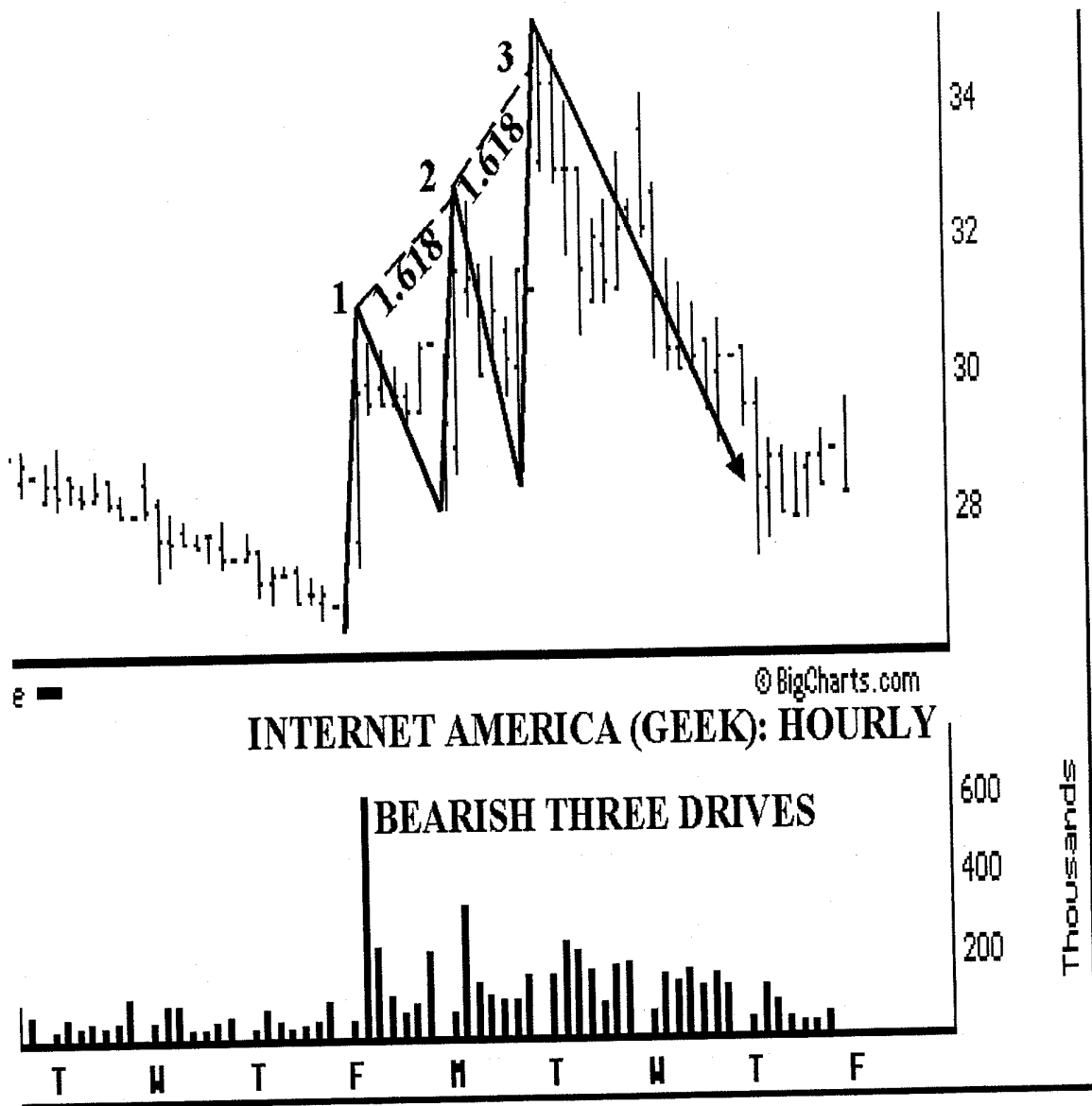

Although the third drive was a bit extended past the 1.618 projection and the price bar exhibited a warning sign of a price gap, this example clearly illustrates the basic symmetry that the pattern should possess. It is important to note that if you waited one price bar, the price action was indicating a reversal, especially since the following price bar showed a bearish formation after the pattern was complete.

This next chart of CNET formed a very nice Three Drives pattern that yielded quite a reversal. Although the thrusts exceeded the 1.618, the pattern was very symmetrical in price and time.

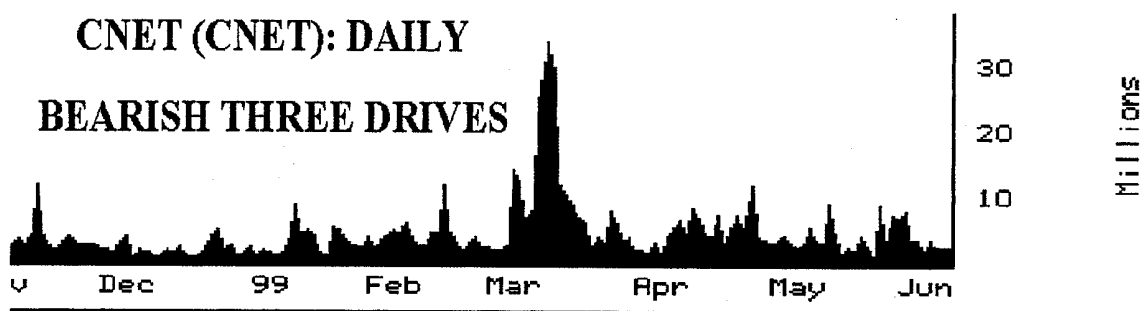
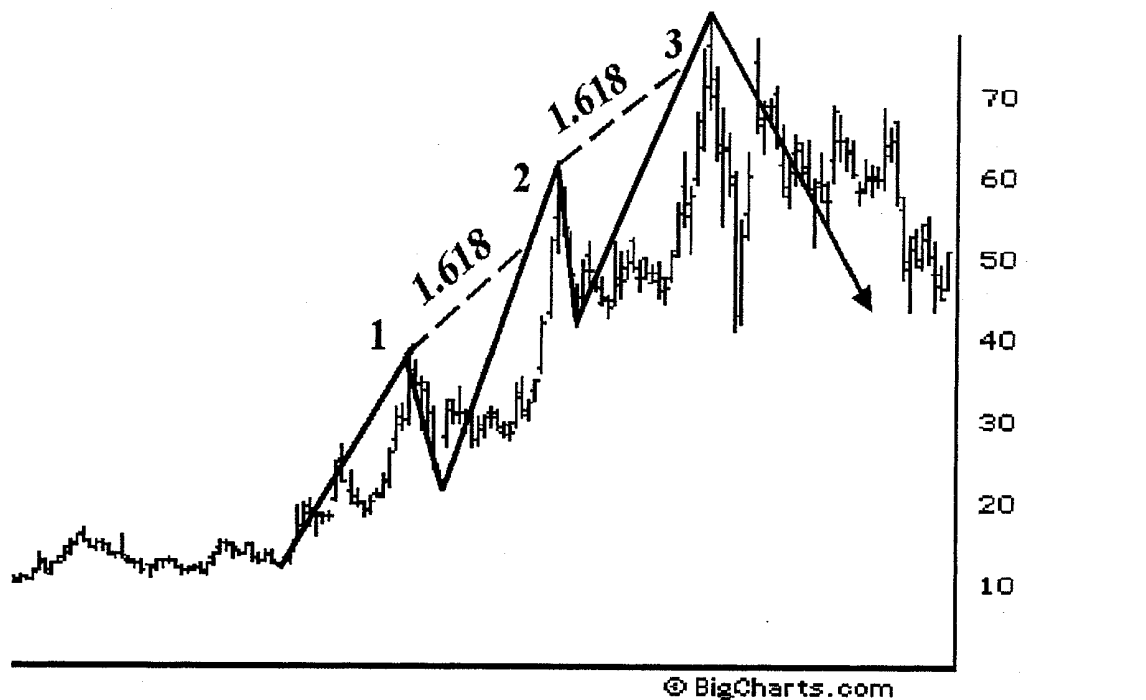

When you see such a clear pattern developing, you must think: "sell!" CNET formed a beautiful Three Drives that developed over a three-month period. In fact, each thrust was almost exactly one month in time, topping out at the beginning of each month. Although the 1.618 of each drive was exceeded, the pattern clearly indicated a top somewhere around 75. The 1.618 projection of the third drive was calculated at $73 \frac{7}{16}$, and CNET reversed at $79 \frac{3}{4}$.

The stock was up sharply the day that it hit this projection. However, the following day possessed an extremely bearish price bar. Such lack of continuation should signal a potential reversal at hand. The stock plummeted within days after the reversal.

Remember, in this pattern, the drives should occur at symmetrical time sequences. Although these time parameters might not be exact, if the thrusts are generally symmetrical the pattern is still valid. The symmetry of this pattern will indicate the completion of the third price move, and the trade set-up can be easily calculated.

Three Drives at a Major Fibonacci Projection

When a Three Drives pattern develops at or near price extremes – either an all-time low or high, it is very common to observe a major Fibonacci projection that converges in the same area of the third drive. These larger projections are very significant because they clarify the potential reversal zone.

Bullish Three Drives

At a Major Fibonacci Projection

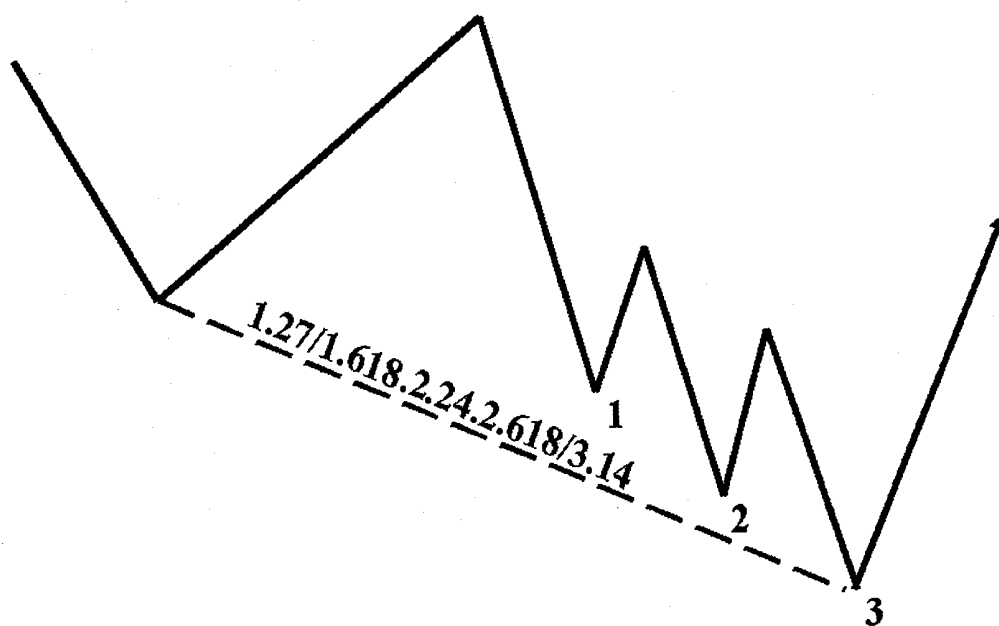

BULLISH THREE DRIVES

AT A MAJOR FIBONACCI PROJECTION:

BUY AT 3!

When a bullish Three Drives pattern develops with a major Fibonacci projection, the potential reversal zone is more clearly defined. Since the third drive only possesses one projection, another harmonic calculation serves to provide greater evidence of the harmonic area.

After suffering a severe decline, Cendant completed a Three Drives pattern around 7. The three drives should be fairly clear and they do stick out at you. Also, each drive completes at the 1.618 of the previous price move. Although the time sequence between each drive is not exactly symmetrical, I believe that these thrusts are geometrically clear enough for this pattern to be valid.

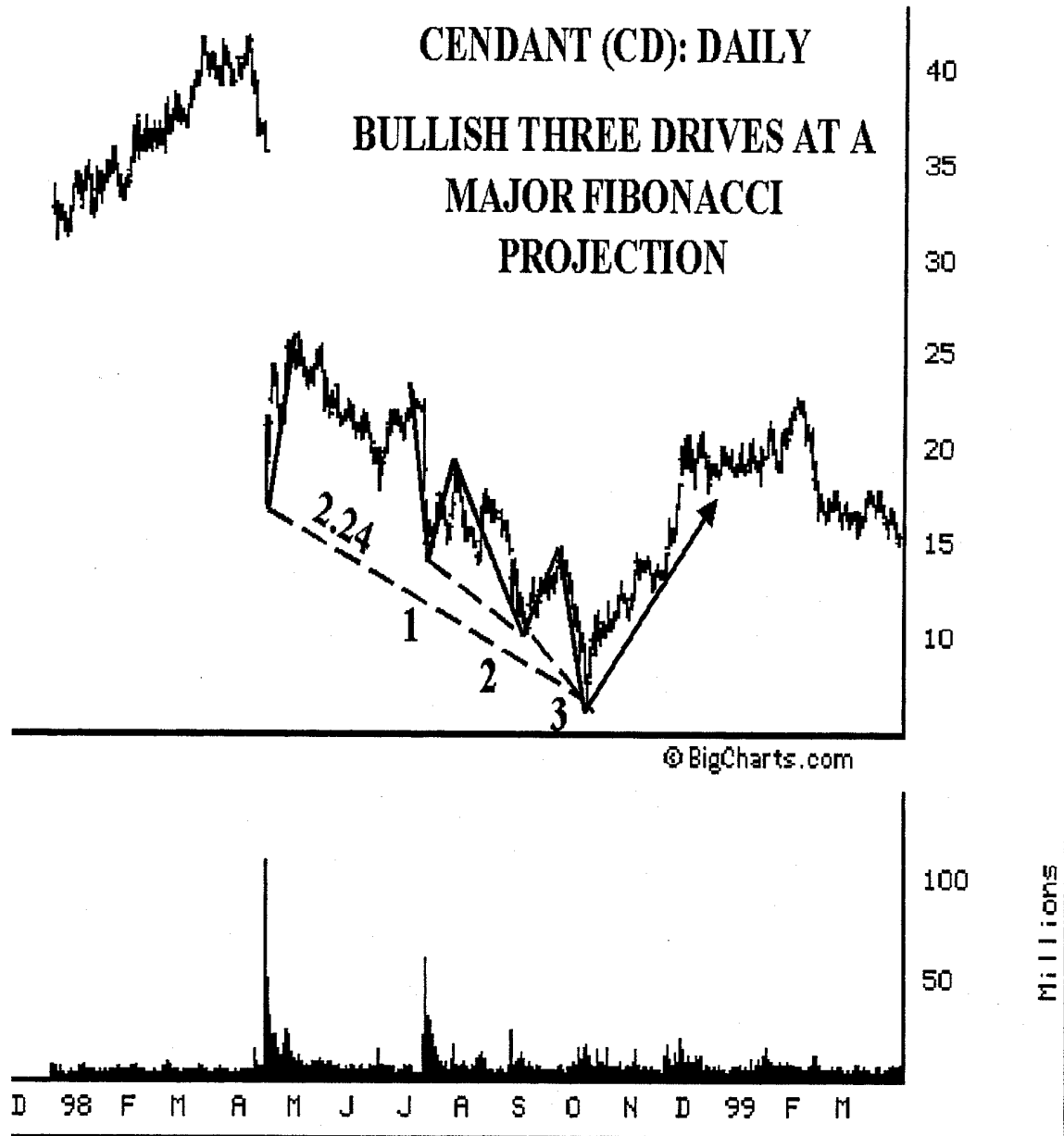

Once the first two drives are established, the third drive can be projected to determine the optimal entry point for the trade. In this case, the 1.618 of the prior thrust would have projected a potential entry point around 5 1/2. This converged with the 2.24 projection, which was calculated at 5 7/8. The stock quickly reversed shy of these two numbers, turning around at 6 1/2, and rallied very sharply over the next six months.

Although the stock reversed above the two projections, the price action clearly indicated a reversal in the works. The following candlestick chart shows how the stock bounced just above this area.

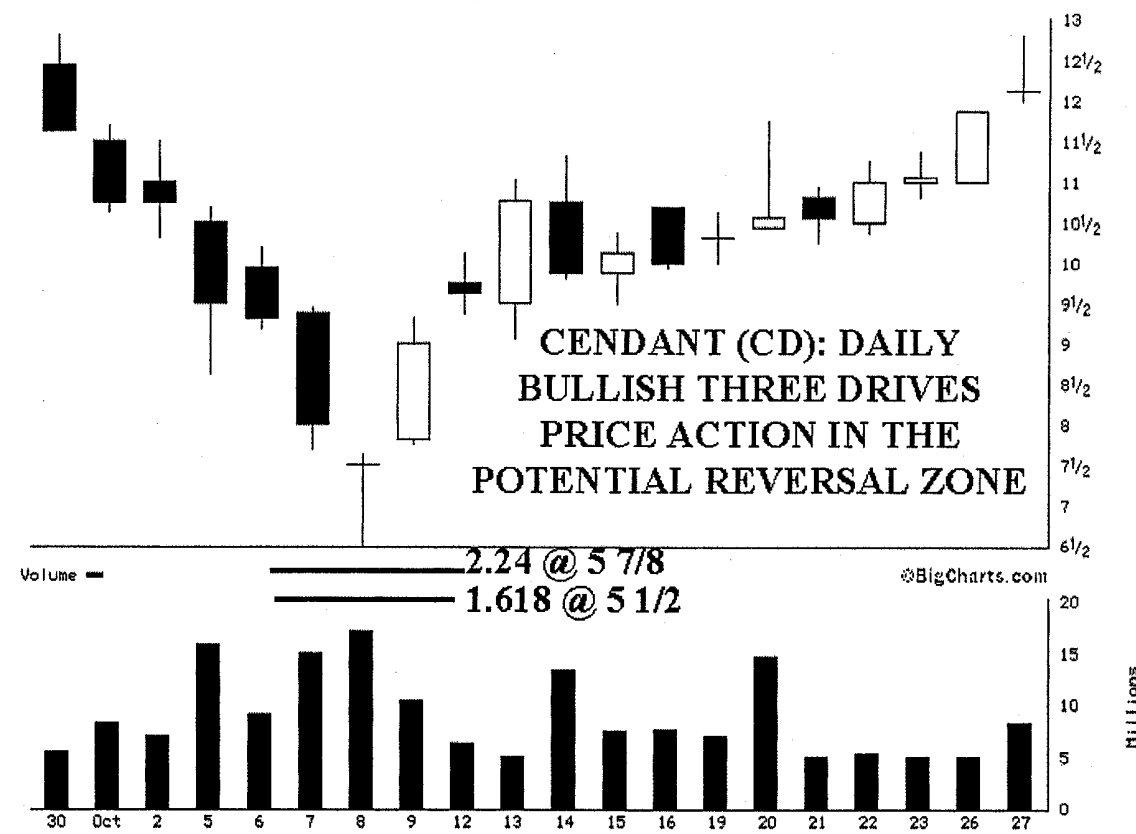

Even if you missed buying the stock on the day it bounced, the price action was clearly indicating a reversal. The doji that formed just above the potential reversal zone was very significant. Also, the following few days were very bullish, as the stock bounced sharply, gapping up on the open the day after forming this candlestick.

This is a fairly good Three Drives set-up to study. I would have preferred to see the stock hit the projections. Also, I normally do not trade stocks that are under \$10. However, Cendant did complete a harmonic pattern that worked out well.

The key to a set-up like this is defining your stop loss limit. If you were assessing this pattern as it was forming a Three Drives set-up, you would assume that the third drive would complete near the 1.618 of the second drive. Therefore, you only had to risk a point beyond this area - maybe at 4 1/2 - to see if the pattern was valid. So, this was another example of a harmonic opportunity that required a small loss limit for potentially a big move.

Bearish Three Drives At a Major Fibonacci Projection

When a Three Drives pattern develops, it often converges with another major Fibonacci projection from a prior decline. The major Fibonacci projection complements the Three Drives pattern. Ideally, the projection should converge with the completion of the third drive. Let's look at the diagram.

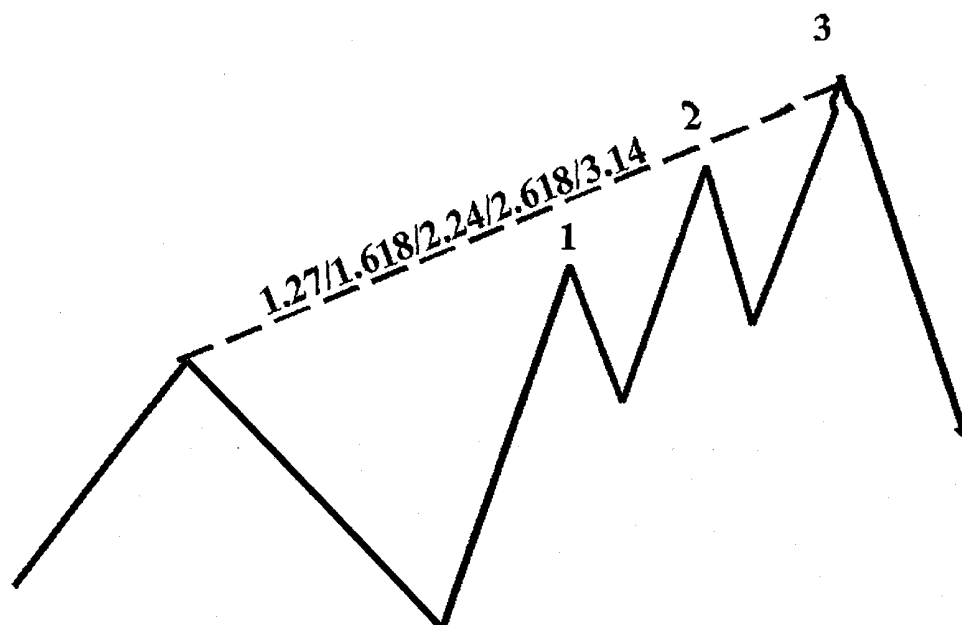

BEARISH THREE DRIVES

AT A MAJOR FIBONACCI PROJECTON:

SELL AT 3!

This set-up is very harmonic, since a major Fibonacci projection is involved. Although I would prefer to wait for the major projection to be hit, the set-up will generally indicate where the stock will reverse. Let's look at an example.

The following daily chart shows how Excite (XCIT) completed a clear Three Drives pattern at an all-time high, which coincidentally converged with a Fibonacci projection from a prior decline.

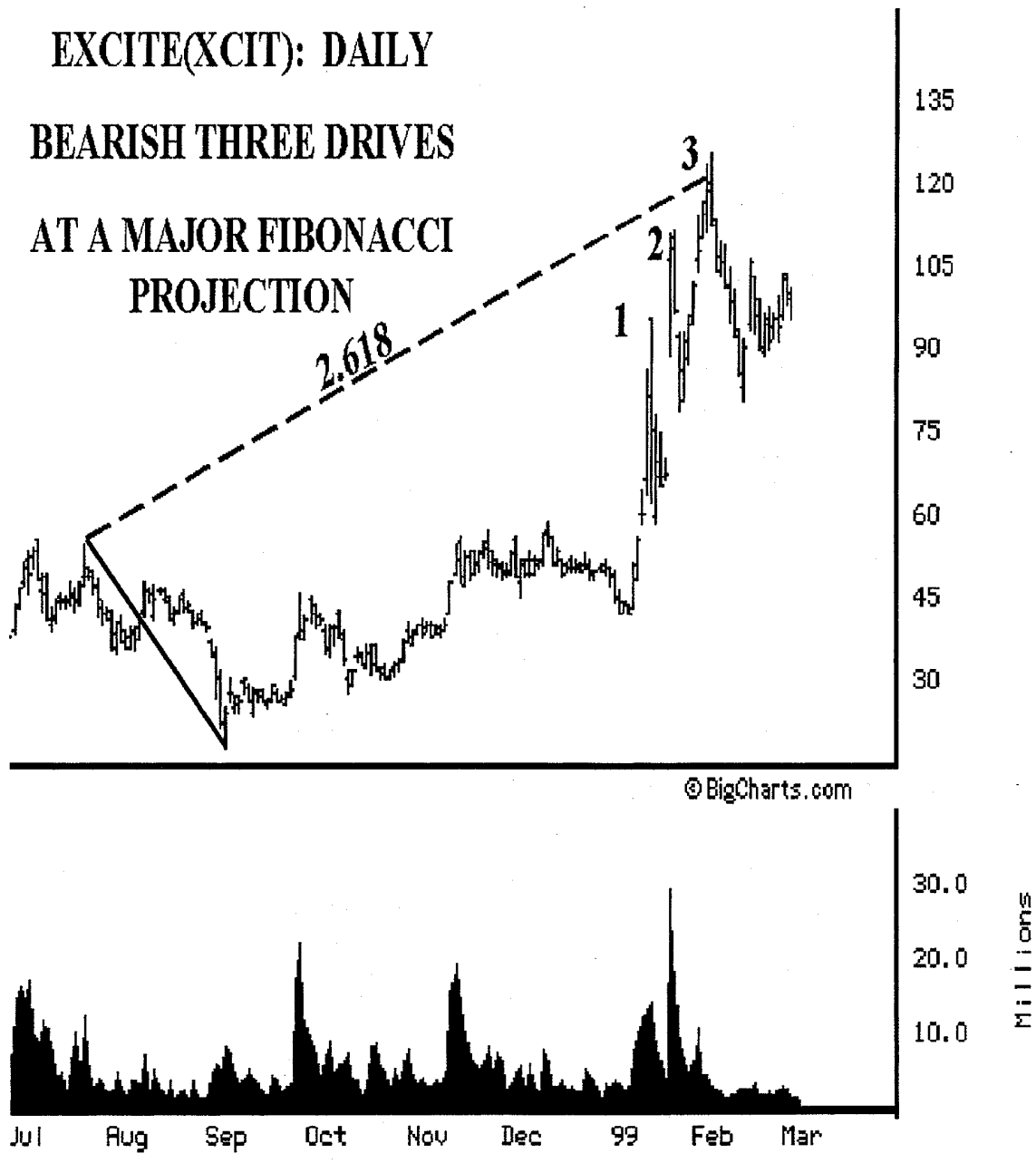

It is uncanny at times that a major Fibonacci projection can converge with a clear pattern and provide greater confirmation of a potential reversal, as this chart illustrates. In this example, it is important to notice how each thrust literally sticks out on the chart. When you see three symmetrical thrusts like these, it is imperative to recognize that a significant opportunity is present. Although the price action in each drive exceeded the 1.27 projection, the pattern is very symmetrical and quite clear. I have included an enlarged chart of the three drives.

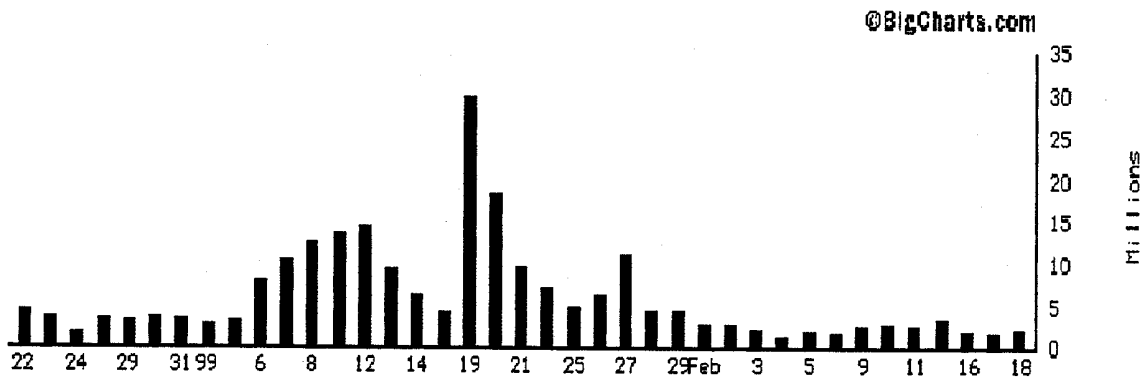
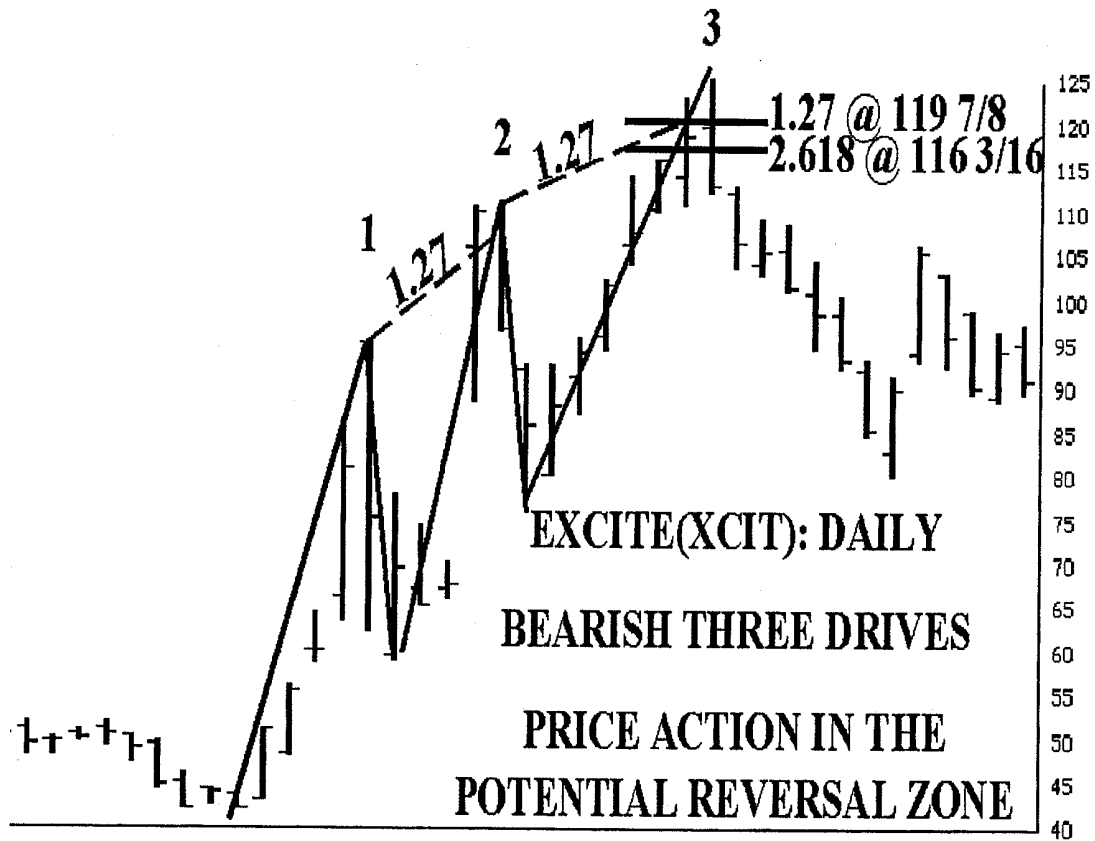

The most important point in this set-up was the third drive. A 1.27 projection of the second drive suggested that the third drive should complete at 119 7/8. This area was complemented by the significant 2.618 projection, calculated at 116 3/16. So, the actual trade set-up suggested waiting until at least this area – somewhere around 120 – for a potential selling opportunity.

The pattern indicated that the 1.27 was the better entry point than the 2.618 projection. The primary reason is that the second drive exceeded its 1.27 by several points. Also, the pattern was so clear that the 1.27 was a very likely price objective.

Although this was a very clear pattern, Excite was rallying sharply as it completed the third drive. On this day, the stock possessed an extreme price range. In these situations, you should respect this warning sign and wait for some type of reversal confirmation. On the next morning, the stock rallied above the potential reversal zone and then reversed sharply. The day after the reversal was complete, Excite clearly gapped down on the open and sold off sharply. In fact, the stock declined nearly 40% over the following two weeks.

This execution might have been difficult since the price action was extremely volatile. The stock rallied over 300% in a few months! Despite this extreme action, the stock clearly reversed from this harmonic area. This example illustrates the importance of gauging the price action in the potential reversal zone. Since the stock was rallying so strongly, you might have assumed that Excite was going to blow out the potential reversal zone. However, the stock clearly indicated a reversal at hand. Furthermore, the days after it hit the potential reversal zone, the price action was very bearish.

Three Drives at a Major Fibonacci Retracement

When a Three Drives pattern does not develop in an extreme price range, it is critical for the three drives to be completing at or near a significant Fibonacci retracement number. Other retracement calculations can provide further confirmation as to where the third drive will complete. In addition, it is very common to see the third drive exceed the previous two drives and hit the larger Fibonacci number. Therefore, as with all patterns, the retracement number from the larger leg will be the most significant.

Bullish Three Drives

At a Major Fibonacci Retracement

This Three Drives set-up is very harmonic, when it corresponds with a major Fibonacci retracement. The Fibonacci retracement complements the pattern and the projection should converge with the third drive.

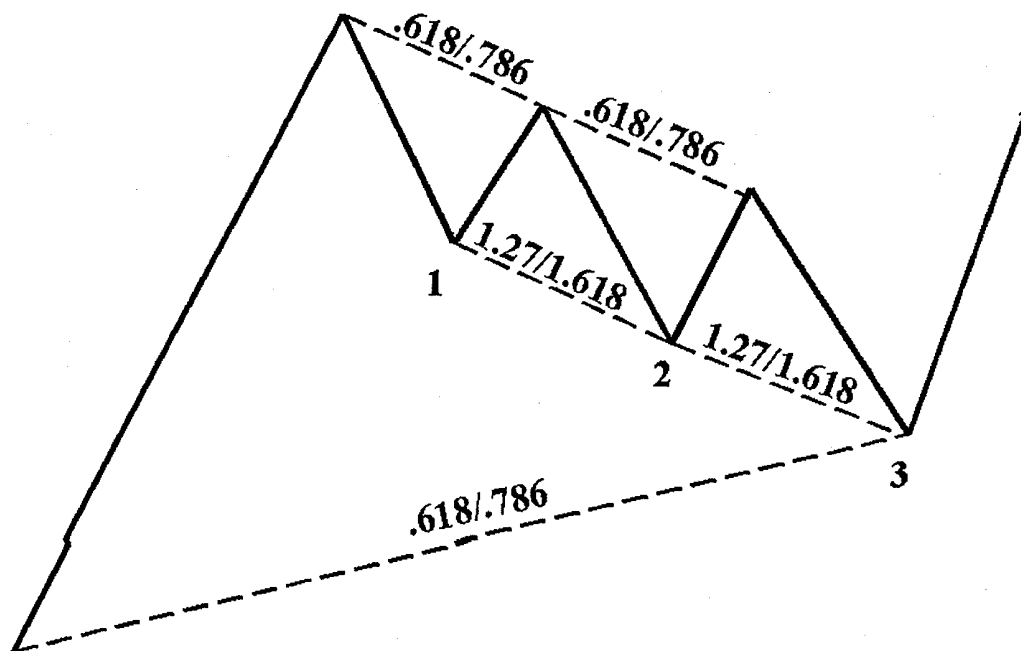

BULLISH THREE DRIVES

AT A MAJOR FIBONACCI RETRACEMENT: BUY AT 3!

The next example will clearly illustrate the concept of this pattern, as Bristol Myers Squibb completed a very nice Three Drives that converged with a major $.618$ retracement. These set-ups are very harmonic because of the clear pattern and Fibonacci projection.

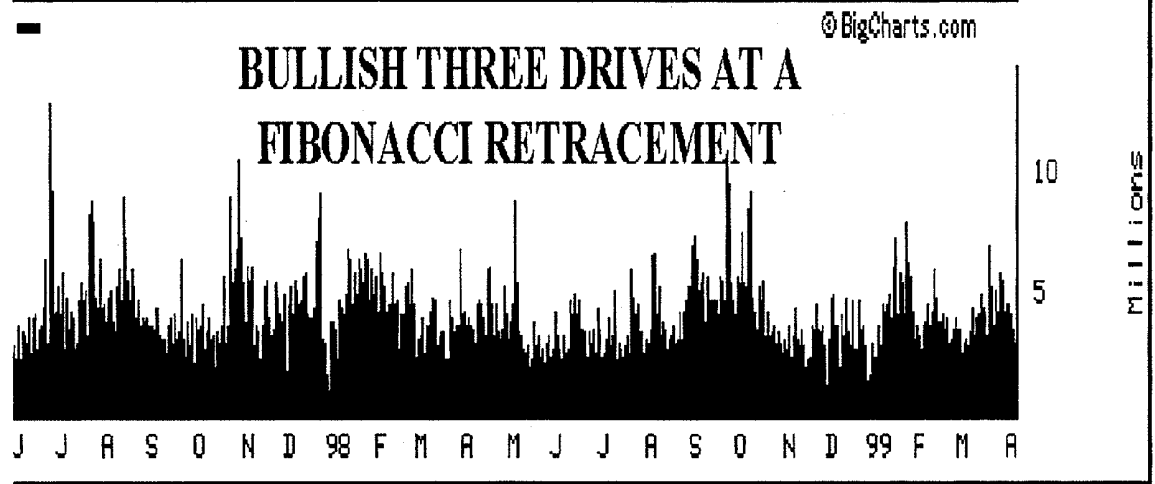
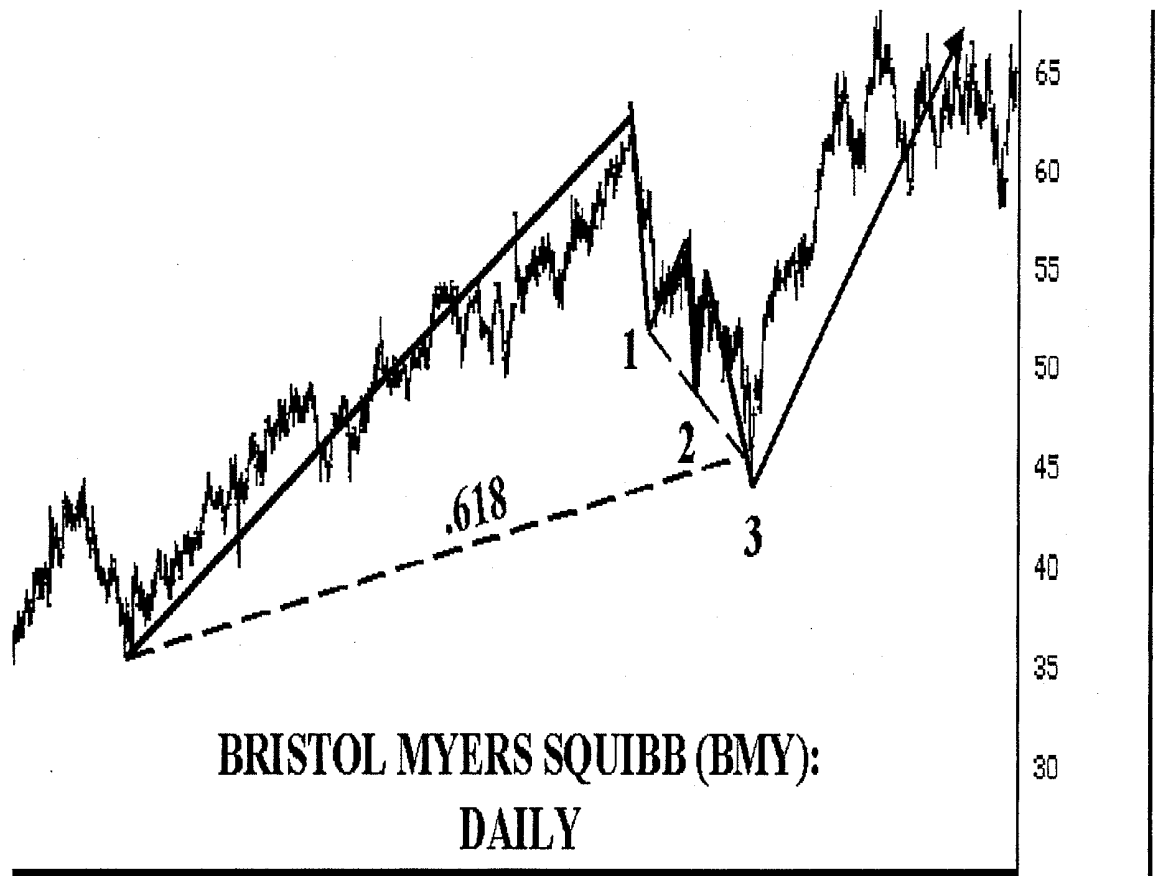

I must admit that this pattern is not exactly symmetrical. However, the three drives do stick out at you. They are distinct enough that this price action does qualify as a valid Three Drives pattern. As you can see, each drive completed at approximately the 1.618 projection of the previous drive. Also, the time between each drive was roughly one month.

Although the third drive did extend slightly beyond this area, the 1.618 projection and the .618 retracement converged within a 1/2 of a point of each other. The 1.618 projection of the third drive was calculated at 45 7/16, which was very close to the .618 at 45 15/16. The stock reversed after slightly exceeding this area, bottoming at 44 1/16. I have included the following candlestick chart to illustrate the price action in the potential reversal zone.

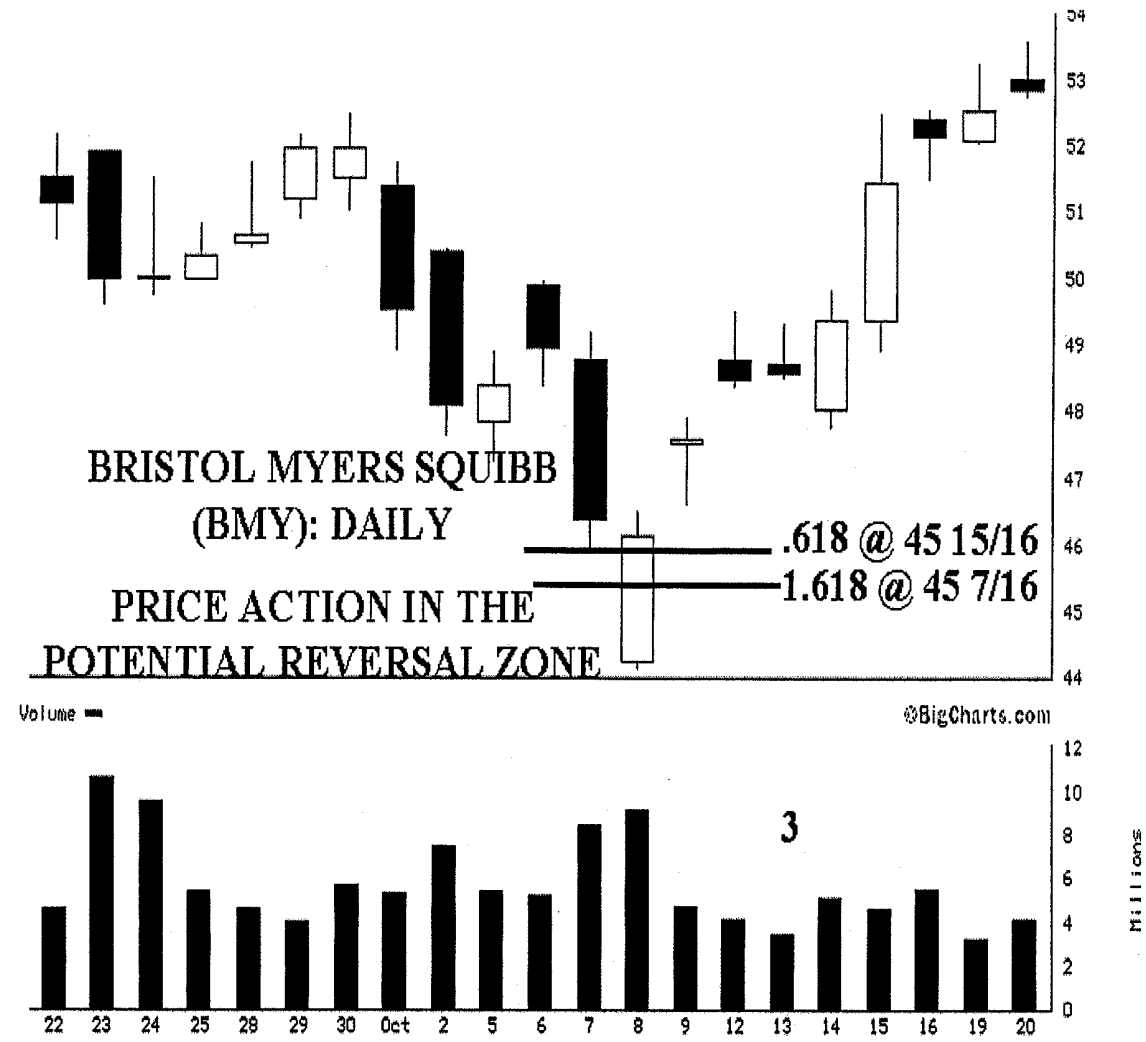

The bullish candlestick was substantial evidence of a valid reversal. Also, the stock closed above the potential reversal zone on the day it hit the entire area. Even if you waited a day for confirmation, the gap up on the open of the following day's trading clearly validated the reversal.

When a situation like this occurs, it is important to allow a greater stop loss limit in the trade. The stop loss could have been placed just past the .618 projection. If this set-up was not going to yield reversal, the .618

projection would most likely have been blown out. Since there were several harmonic projections converging in the area just above 45, the pattern would have been invalid, if the stock fell below 43. Also, a close below the entire potential reversal zone would have invalidated the set-up.

Bearish Three Drives At a Major Fibonacci Retracement

Similar to the other Three Drives set-ups that include a major Fibonacci number, this bearish pattern is very clear, as well. A stock often experiences resistance a major Fibonacci retracement, such as the .618 or .786. When a stock forms a Three Drives pattern at a major retracement, it frequently will yield some type of reversal.

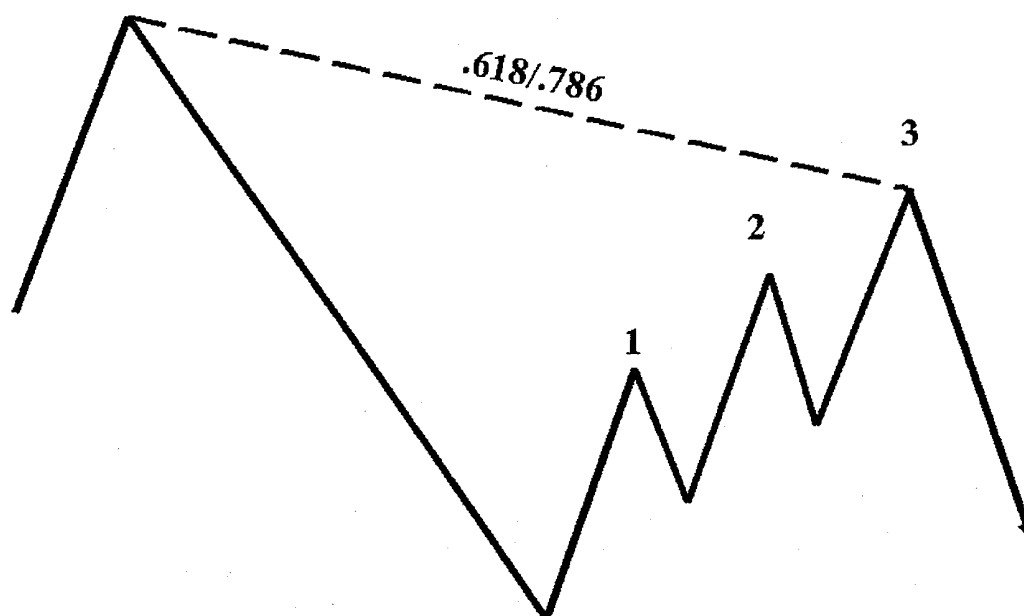

BEARISH THREE DRIVES

AT A MAJOR FIBONACCI RETRACEMENT:

SELL AT 3!

The combination of the major Fibonacci number and the Three Drives is no coincidence. If a stock forms this set-up, you must respect the potential resistance and examine the price action closely. If a reversal occurs, it usually is quite significant. However, if a clear pattern

materializes at a major Fibonacci retracement and rallies through this area, this would indicate strong price action. The following example will illustrate the concept well.

Citigroup formed a clear Three Drives pattern. Although this pattern was not in an extreme price range – either an all-time low or high, the third drive was completing in an area that converged with a major Fibonacci retracement. When this situation arises, it is usually a good set-up. I would prefer an ideal Three Drives pattern in a price extreme. But, when three distinct and symmetrical thrusts materialize, a potential reversal is very probable. This type of a Three Drives pattern really should be considered only when another Fibonacci retracement is present. In this situation, Citigroup did sell off sharply, as it lost almost ten points in a few days. But, the stock recovered quickly. Citigroup rallied above this reversal, which usually suggests that the stock is strong.

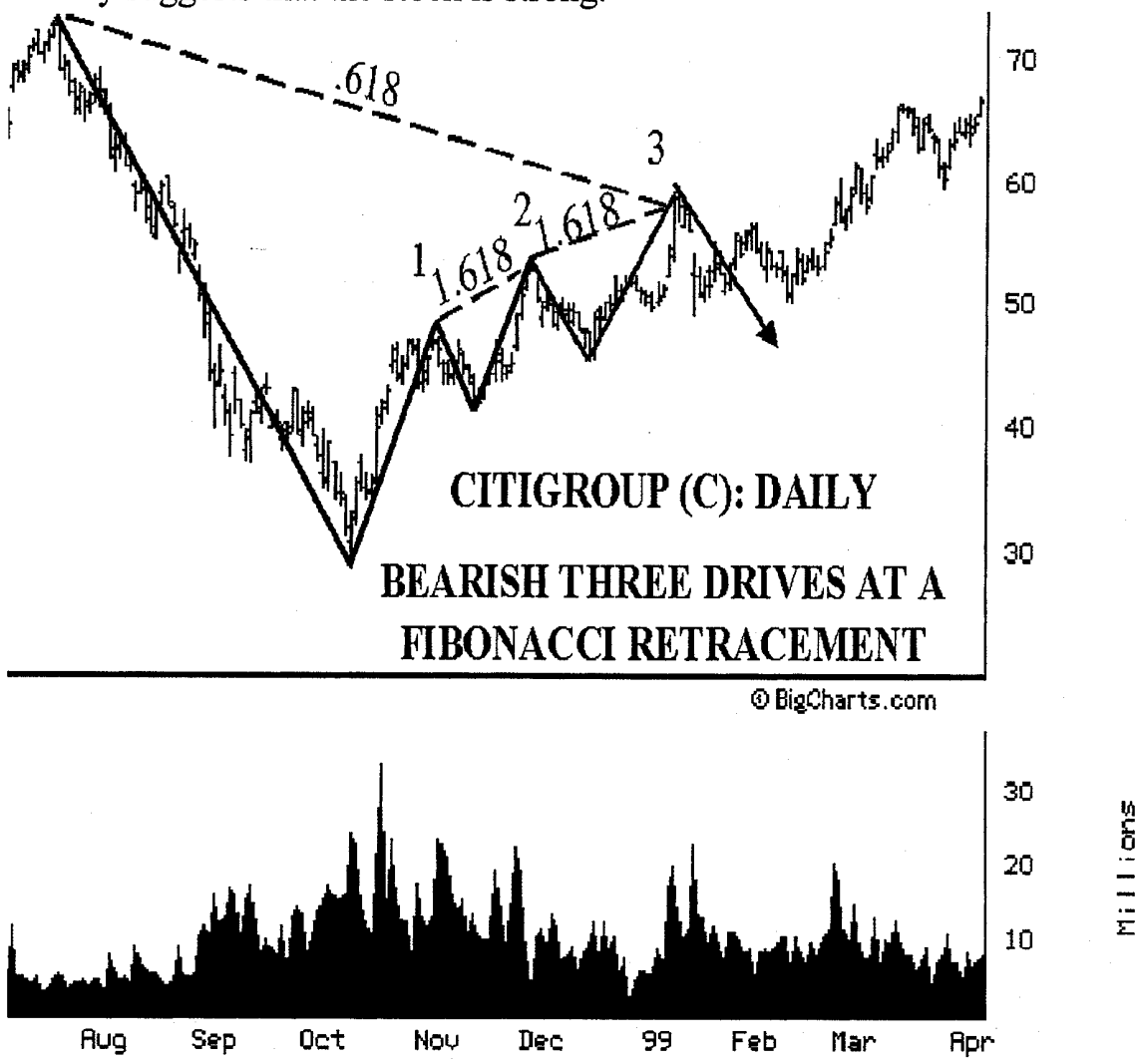

Other market technicians might consider the three drives as merely an Elliot Wave pattern. Although the three drives might exhibit, a five-wave Elliot pattern, identifying an ideal Elliot wave set-up can be more difficult than focusing on the three impulse drives. Remember, the three impulse drives must be very similar to each other. Also, a critical factor about the three drives is that the third drive must not be exceeded after the reversal is established. If the third drive is violated, the pattern is invalid. So, when a Three Drives pattern is identified, it creates a favorable set-up where the stop loss limit is relatively low.

Three Drives Summary

The Three Drives pattern is a powerful reversal signal. Although it does not occur as frequently as a Gartley or a Butterfly, the Three Drives represents a substantial opportunity for profit. Remember, this pattern should “stick out” at you. If the pattern is not obvious, you are probably trying “to force” the pattern. Similar to the Butterfly, the Three Drives pattern usually will appear in extreme price areas – either all-time highs or lows. When the pattern does not develop in price extremes, it can signify reversals only when it coincides with major Fibonacci retracements or projections. I strongly recommend that you memorize the ideal set-up, since it is the most obvious of all of the patterns.

Part IV

Learning the System: Putting it All Together

17

Potential Reversal Zone Confirmation

Once you have identified a harmonic set-up, there are other signs that will define the potential reversal zone more clearly. Although these other indicators should merely complement this area, they can provide even greater confirmation of the validity of a potential reversal. Also, these other indicators can indicate the optimal entry point for a trade.

Referencing Other Charts

When a potential reversal zone has been identified, other charts with varying time frames should be referenced to determine the validity of the set-up. For example, if you are using a daily chart, weekly or intra-day charts should be examined to determine the optimal trade execution point. In particular, intra-day charts, such as 15, 30 or 60-minute time frames, provide even greater guidance for a successful trade execution.

When a potential reversal zone is identified, there are often 3, 4 or more harmonic calculations that define the area. The problem lies in knowing which number within that zone will prove to be the reversal point.

Weekly and intra-day charts contain similar patterns and Fibonacci retracements that are observed on daily charts. Therefore, if these other charts are cross-referenced with the daily set-ups, greater accuracy can be achieved in the trade execution.

The convergence of other time frame projections is very effective in defining the optimal point for a trade execution. Even when there are no patterns present on intra-day charts, Fibonacci retracements can provide greater indication for further reversal confirmation. For example, let's say that you have identified a set-up on a daily chart that suggests good potential for a rally. We are looking to buy in a bullish potential reversal zone. However, this area has Fibonacci numbers and a pattern that have defined an area that is a rather large point range. It would be very helpful to consult a 15-minute chart, for instance, to determine the area within the reversal zone, which would be the most advantageous entry point.

The following chart of America Online demonstrates this technique. AOL formed a very harmonic set-up in June 1999. However, the stock was very volatile, as AOL declined from a high of 175 1/2 and bottomed at 89 1/2.

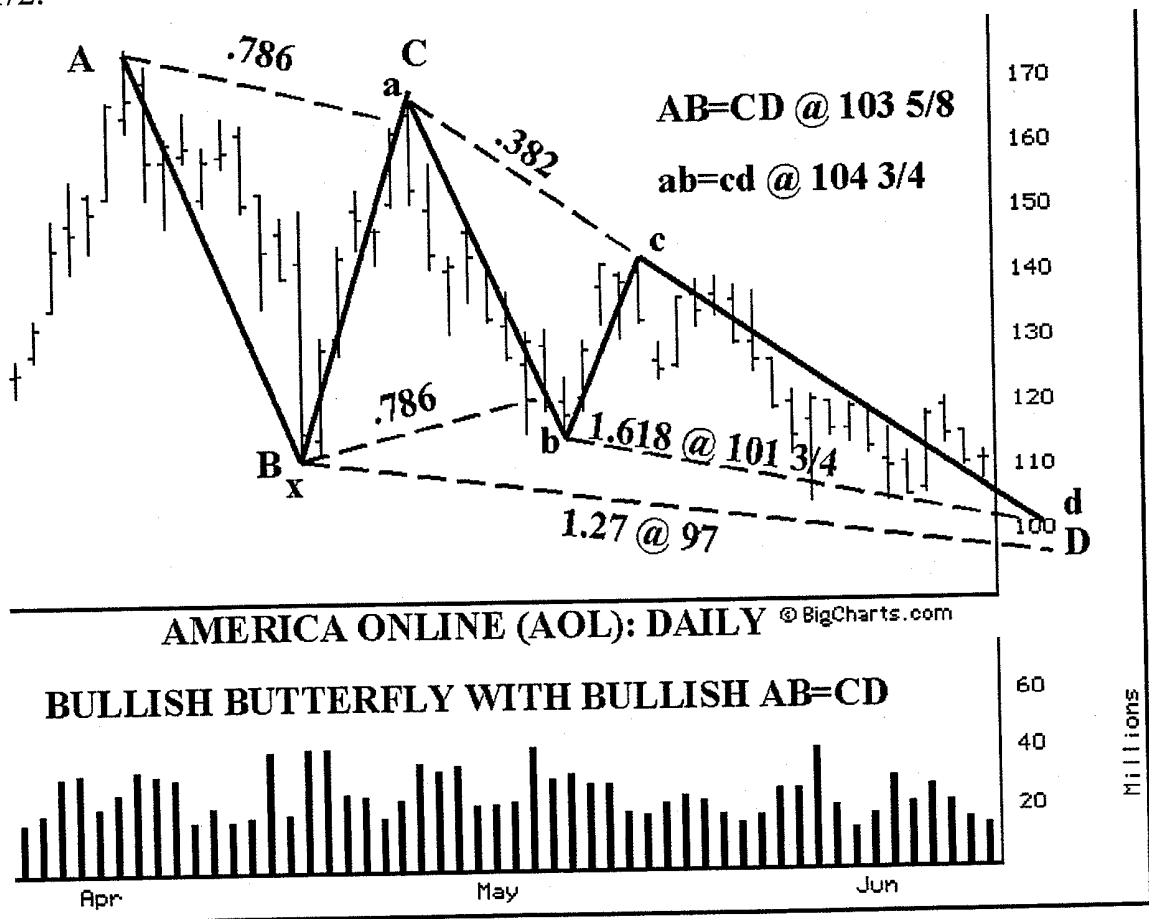

The potential reversal zone possessed five numbers that defined an excellent area to buy the stock somewhere around 100. Although the potential reversal zone was rather large, it was still a very harmonic set-up. There were two patterns, a bullish Butterfly and a rather significant AB=CD pattern, that converged in this area. Both of these patterns defined a rather large potential reversal zone between 97 and 104 5/8.

There was another significant retracement that converged with the completion of the bullish Butterfly. The next chart shows the 50% retracement from a long-term low to the recent high that was calculated at 96 3/8. This is very substantial because it was less than a point beyond the 1.27 of XA. In addition, it was a retracement that was nearly a year in length.

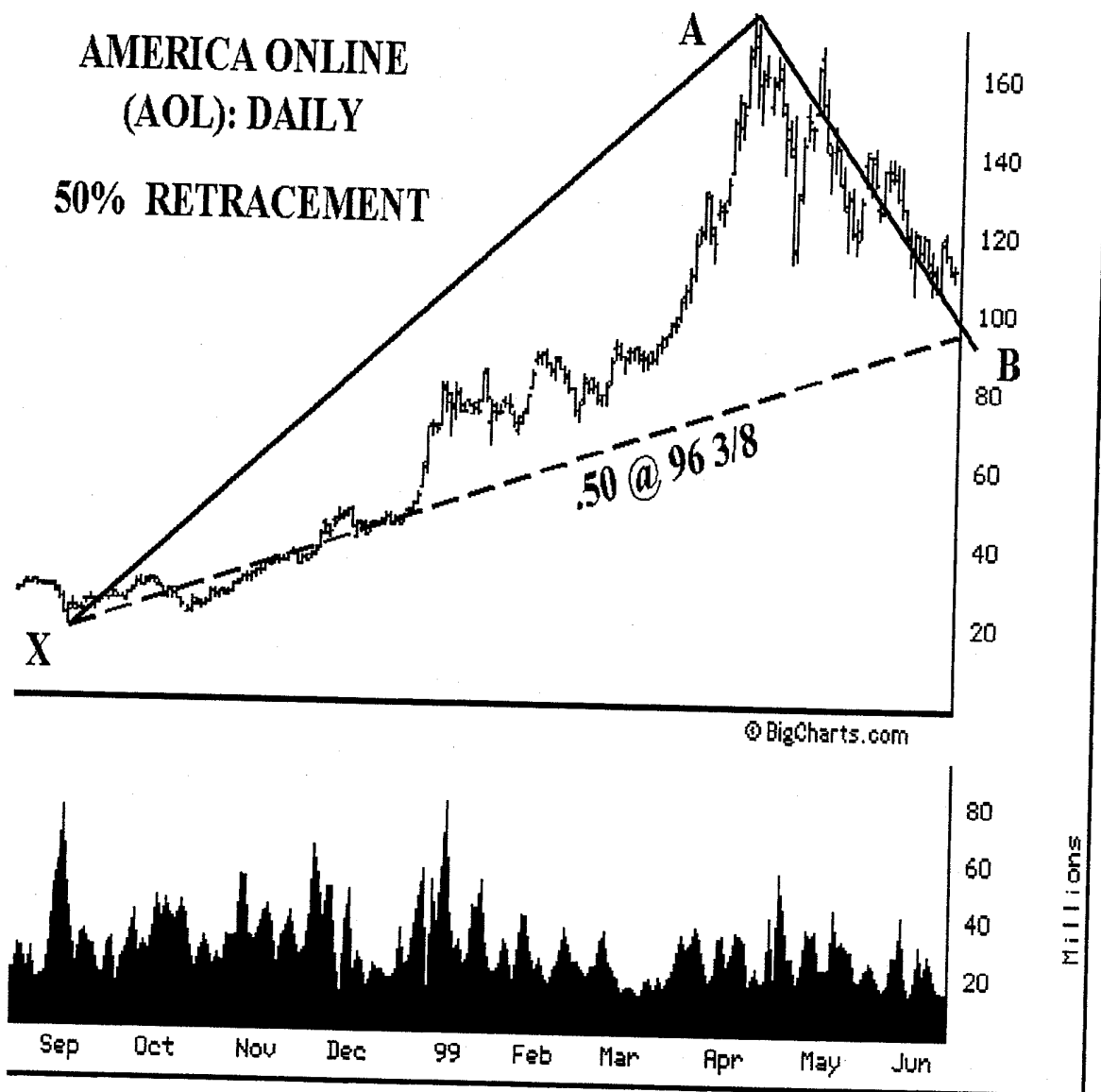

With such a major retracement, I was confident to wait for this area. I referenced an intra-day chart to see if any short-term projections were converging in this area. Interestingly enough, a clear 1.618 projection converged in this mid-90s area. It was projected at 95 1/2. The following chart shows the intra-day projections.

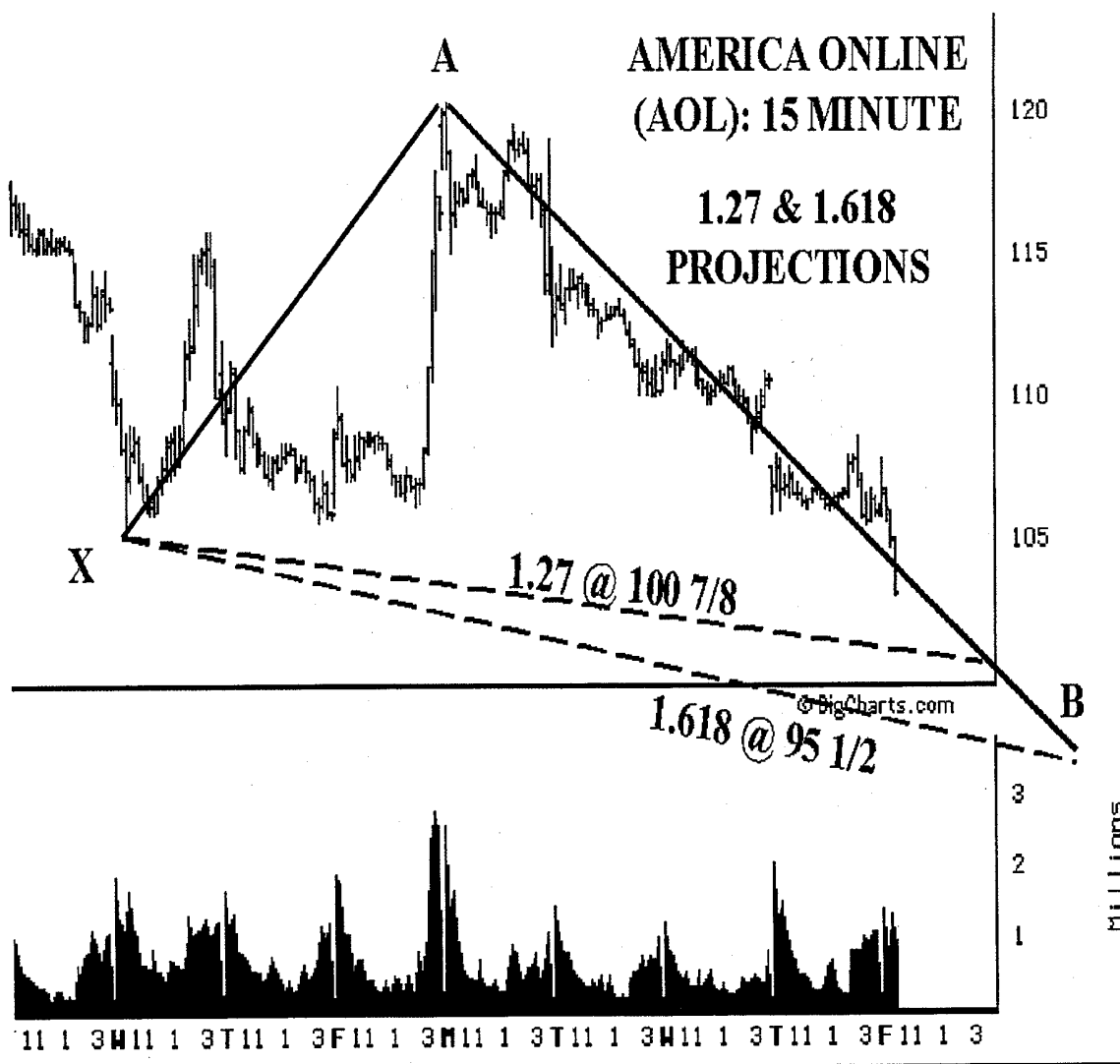

This intra-day chart confirmed the mid-90s area, as the optimal execution point for this potential reversal zone. I definitely wanted to wait for the stock to hit the 1.27 of XA at 97 because I thought the Butterfly was a very harmonic pattern. Also, the combination of the 50% retracement with the intra-day 1.618 projection defined a very significant area.

Although there were several harmonic calculations in this area, AOL sold off sharply on the first day it hit the potential reversal zone. In fact, the stock gapped down on the open, and it sold off over 11 points at one point. Due to these warning signs, I avoided the trade, and I waited for some confirmation of a reversal. The next day the stock experienced another significant decline. I have included the following hourly chart of all of the harmonic calculations in the potential reversal zone.

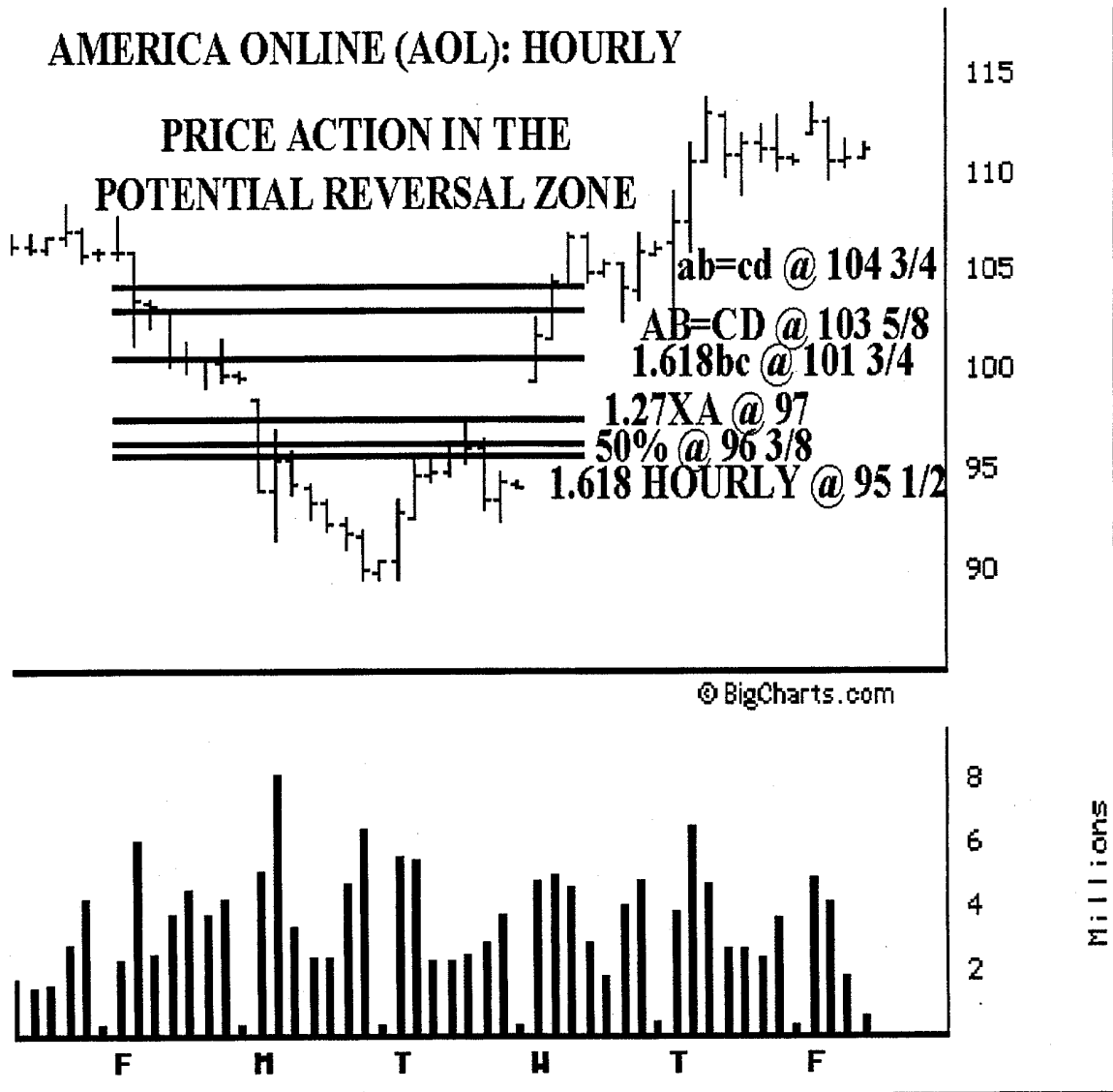

As you can see, the stock sold off sharply, after it entered this potential reversal zone. The most important number in this trade, 1.27XA, was calculated at 97. The 1.618bc projection of the Butterfly complemented this area, since it was calculated at 101 3/4. The problem with this set-up

was the two other AB=CD patterns that converged around 104. These completion points were several points above the lower range of the potential reversal zone. But, the price action clearly blew out this area. Referring to the hourly chart, AOL declined sharply and it never provided any reversal clear signals. The warning signs on these days would have kept you out of the trade.

As I was following this set-up, I thought that the stock was going to head much lower. But, AOL bottomed on the third day at 89 1/2 and started to rally. The day after the stock completed its reversal, it gapped up on the open and started a strong uptrend. In fact, the stock rallied nearly 25 points in the three days after the reversal.

Although the previous hourly chart may seem confusing, the convergence of all of these harmonic calculations clearly indicated that this was a very significant area. The combination of intra-day, daily and weekly numbers is an excellent means of determining the optimal execution point, as this example illustrates. It is important to know these other harmonic calculations, as they will gauge the price action on various time frames.

In this example, America Online possessed a very harmonic set-up on three time frames. When such a situation occurs, it is important to understand that the stock is in a very critical area. These critical areas will identify very profitable opportunities, and provide assurance of valid reversals.

Prior Gaps in the Potential Reversal Zone

Once a potential reversal zone is identified, it is important to look for any prior gaps in a stock's price action that corresponds with this area. Often, a prior gap will get filled when it occurs within a potential reversal zone. I utilize a rule of thumb, which states that most prior gaps get filled – sooner or later. Although I can not provide exact statistical evidence to prove this rule valid, I can state upon observing thousands of charts that prior gaps are filled more than they are not. Therefore, prior gaps provide even further indication of a potential reversal.

The chart on the next page of Applied Materials demonstrates the effectiveness of using a prior gap to confirm a potential reversal zone. The stock formed a bearish Gartley that had three harmonic numbers and a prior gap within a very tight area.

The Gartley pattern was very clear. The potential reversal zone consisted of: 1. $.786XA$ at 68; 2. $AB=CD$ at $69 \frac{13}{16}$; 3. $1.27BC$ at $69 \frac{3}{4}$. The prior gap converged nicely in this area, which was filled at $68 \frac{1}{4}$. With all of these numbers in such a tight area, the probability for a reversal was quite high.

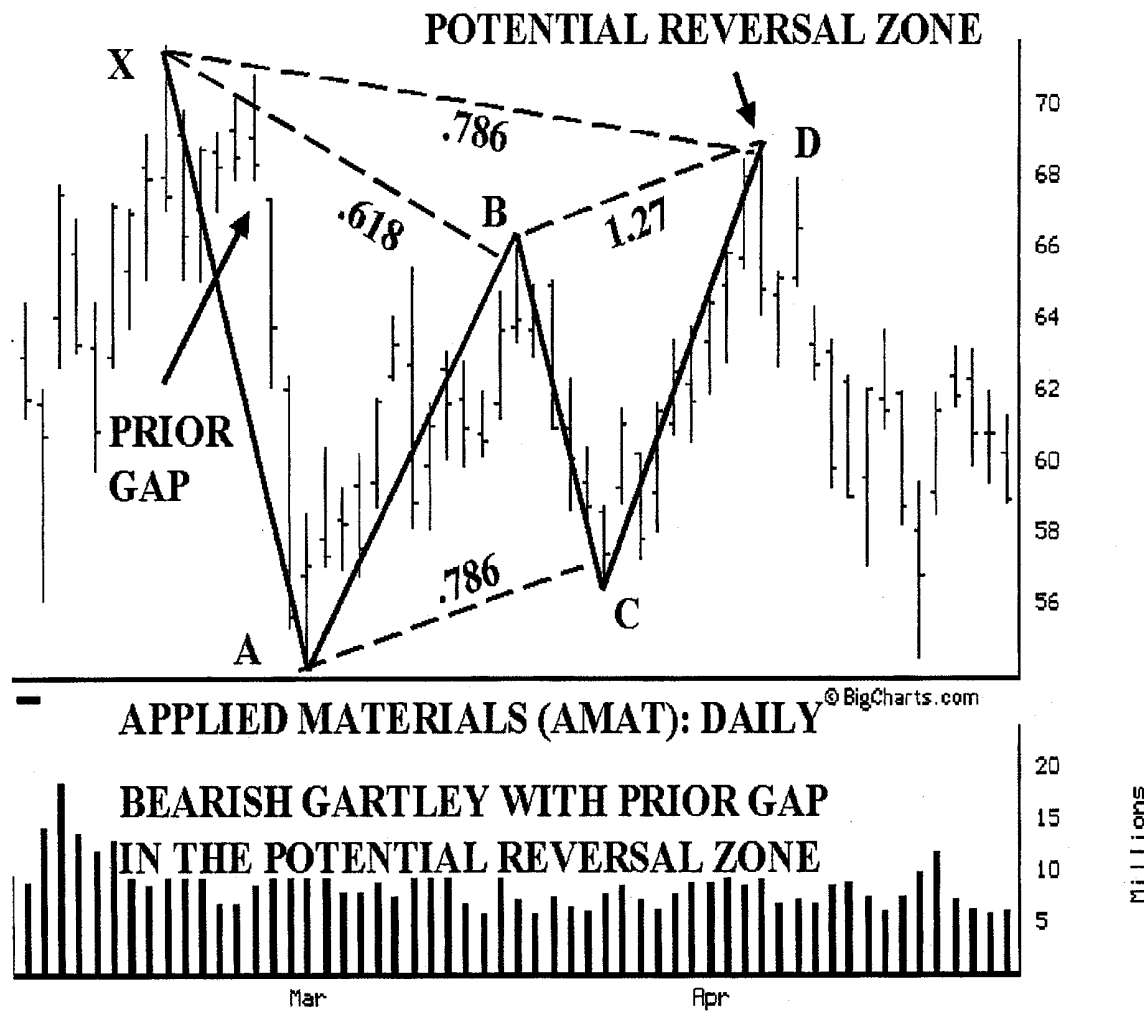

Price gaps are significant because they mark a place in the history of a stock's price action, where mass perception of has changed in a dramatic fashion. This price action is especially significant when a gap is followed by a wide price range and/or tail close. So, when an unfilled gap is in the same price area as a potential reversal zone, it is important to recognize this as an especially significant opportunity.

The next chart also illustrates the importance of prior gaps in a potential reversal zone. Broadcast.com completed a very bullish Gartley

that possessed a very harmonic area. The stock possessed five harmonic calculations and prior gap in this area.

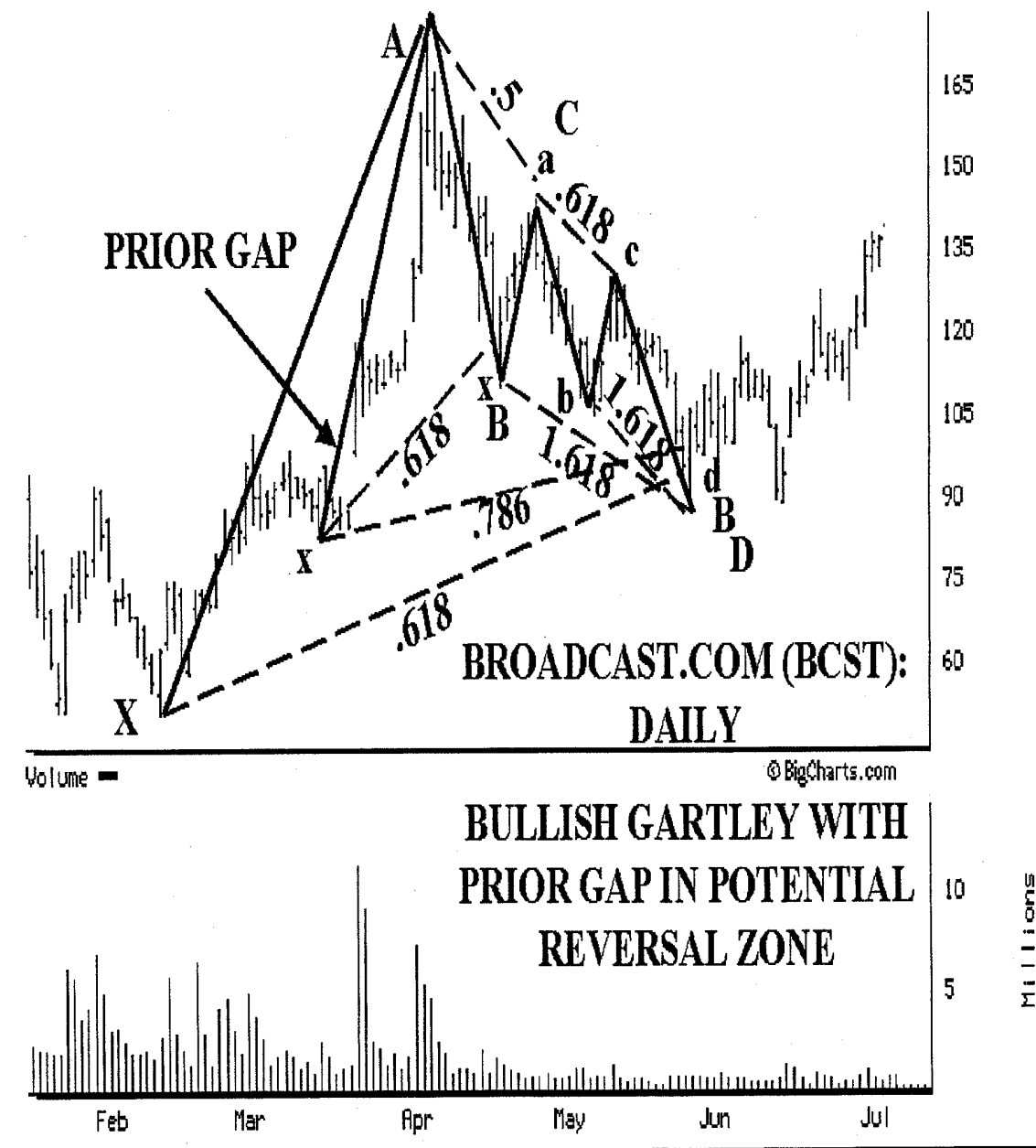

It has been my experience that prior price gaps generate some type of bounce. In combination with a potential reversal zone, prior gaps can provide excellent trading opportunities. The price action can be extreme in these areas, as reversals frequently occur sharply after filling the prior gap. But, these opportunities are especially significant.

Volume

Volume can often provide a clear signal of potential reversals, especially when a stock hits a potential reversal zone. The most important concept of volume in the potential reversal zone is to focus on an extreme. When I see a huge volume spike, either on the downside or upside, I must assume that the stock has become exhausted. I state this with one condition: the reversal must occur very close to that exhaustion point. Although the evidence of a volume spike in the potential reversal zone does not always yield a reversal, its existence adds to the probability of a change in trend. It is important to be aware of such phenomenon, as greater indication of a reversal. Let's look at an example.

The following chart of Becton-Dickenson clearly illustrates how an extreme volume spike can signal a potential reversal at hand. This set-up was very harmonic, as it possessed two Butterfly patterns, two AB=CD patterns, and five harmonic calculations in the potential reversal zone.

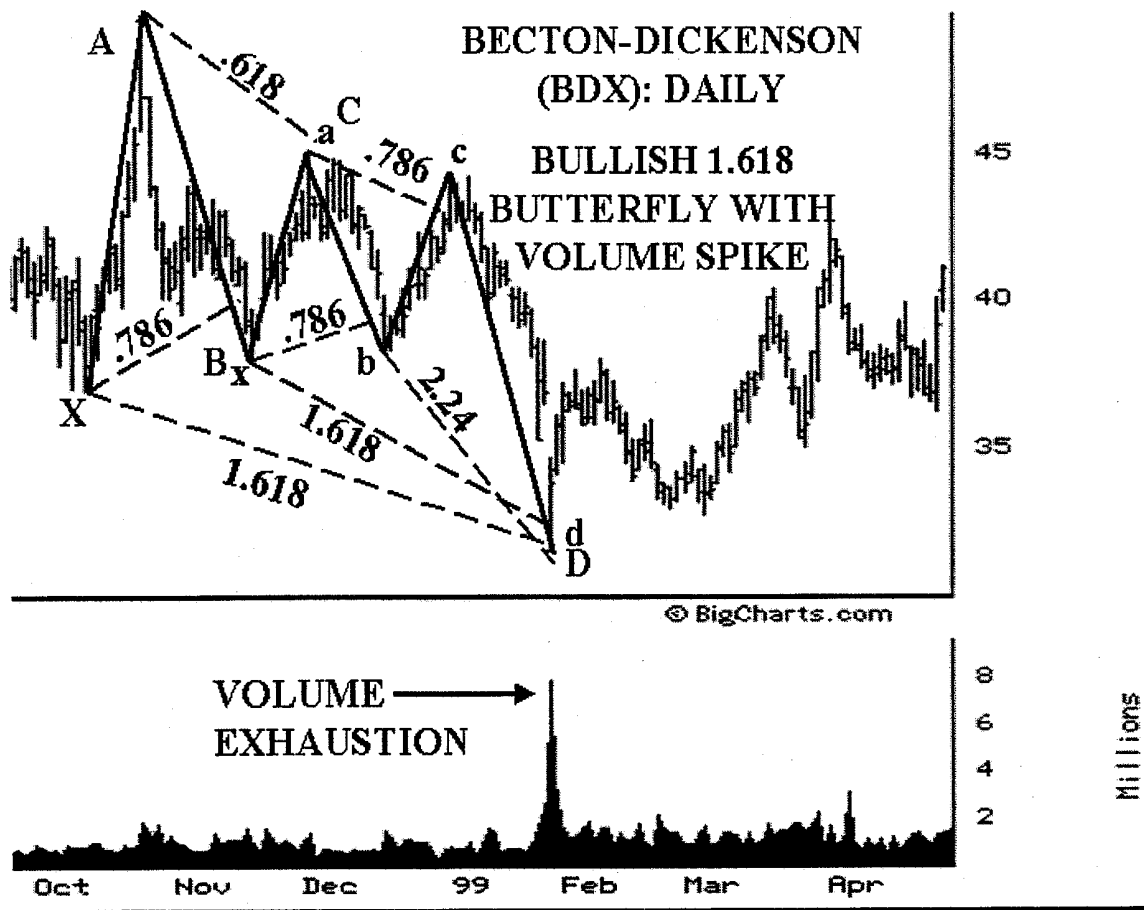

This potential reversal zone contained five harmonic calculations that all converged around 33. Such a harmonic set-up is a highly probable reversal area. The convergence of these numbers and the obvious volume spike indicated a significant area for a bounce.

Although the price action was quite strong on the day it hit the potential reversal zone, the price action and the volume exhaustion indicated a significant reversal in the works. Even if you waited a day for clear confirmation of the reversal, the set-up projected an important bottom in the stock.

Volume spikes frequently indicate a state of exhaustion. Although volume spikes will not appear in every set-up, such a phenomenon complements a harmonic set-up very nicely.

Utilizing these other signs will help determine the validity of a potential reversal zone. Although they do not occur in every set-up, charts with other time frames, prior gaps and volume extremes can improve executions. When these signs coincide with a harmonic area, they can provide greater assurance of a successful trade.

18

Scanning for Stocks

I maintain a group of several hundred stocks that I review throughout each week. Although this might seem like a large list of stocks to follow, it is not too time consuming to review once your eyes are trained to identify patterns. In fact, most Internet sites allow users for no charge to maintain a portfolio of stocks to track. In addition, advanced stock software programs permit users to just point and click on a list of stocks to pull up charts. So, I recommend that you utilize a good chart service that makes screening a large population of stocks very feasible.

The patterns will become easier to identify after some time of study. The more charts you examine the more the patterns will begin to jump out at you. Once you are able to identify the basic patterns, the scanning process becomes rudimentary. It is important to remember that you will not find trade set-ups every day, or even every week. This methodology requires patience. If there are not clear set-ups available, I recommend that you just wait for them to materialize - because they will.

When there are no clear set-ups available, it is important to resist the urge to trade. These patterns should become so ingrained in your trading mentality that harmonic set-ups represent the only opportunities available. Mark Douglas, author of the Disciplined Trader, suggests: "think of not trading as putting money in your pocket." I agree with him.

Without the reliable harmonic set-up, any trade that is not executed in accordance to the trading rules becomes a random event. You are straying from the trading plan. On many occasions, I have put on "seat-of-my-pants" trades, buying or selling on a hunch. Honestly, my performance with these trades as compared to harmonic set-ups is miserably poor. In fact, when I buy or sell on an impulse I am usually wrong! Therefore, when there are no harmonic set-ups available, DON'T TRADE!

Once you are able to quickly identify potential patterns, the entire scanning process becomes simple. Each stock that you examine will take only a few moments to determine whether or not a potential set-up exists. The most important clue that I look for is some type of AB=CD pattern that appears to be developing. Since the AB=CD is a basic pattern that exists within all of the complex patterns, it is an easy way to quickly scan stocks. In addition, the AB=CD pattern should "stick out at you," where the legs of the price movement are very clear. Again, it is important not to force the pattern.

After you notice a potential pattern developing in a stock, you can proceed to calculate some Fibonacci retracements to determine the reversal zone. A reversal zone should have at least two numbers within a specific area, although I prefer three. After you develop some experience in calculating the Fibonacci numbers, your eye will be trained to look at the general area of where the retracement percentages are located. For instance, you will be able to differentiate between a .618 versus a .786. Or, you will be able to look at a price chart and determine if an extreme price move has exceeded the 1.618. Training your eye "to gauge the numbers" will further facilitate the screening process.

After you define the pattern and the potential reversal zone, it is important to study past price action. Although this does not require calculating every price move on the chart, it might be helpful to see if the stock has acted harmonically in the past. Also, it is important to see if there are some Fibonacci numbers that are more prevalent reversal points than others. When certain numbers reoccur throughout a price chart, it will help identify potentially higher probability trade set-ups.

If a stock seems to possess all of the characteristics of a harmonic set-up, it is important to prepare for a potential trade. First, print out the chart; then draw the basic framework of the pattern that you have identified. After drawing the pattern, illustrate the set-up by connecting the actual points with

the Fibonacci numbers. This will help illustrate the price action within the potential reversal zone.

Preparing the trade in advance is essential to ensure a successful trade execution. However, when I say successful, I don't mean that every trade set-up is executed either. Since anything can happen in the stock market, it is important to prepare yourself for various possibilities. The preparation of pattern recognition and Fibonacci calculations identifies a potential set-up. But, the important factor in executing your plan is to determine whether or not the trade is valid.

It is essential to use the warning signs previously mentioned in this book. A successful execution is determined by the relevant market price action at the time the stock is trading in the reversal zone. For example, if a stock rallies strongly through a reversal zone, the trade set-up might not be as good of an opportunity as the numbers might suggest. Or, the stock might be heading for another potential reversal zone at another group of numbers. Therefore, it is important to gauge the price action of the stock within the reversal zone.

19

Tools for Trading

Although there are several software programs that are capable of calculating Fibonacci numbers, the tools required to utilize this methodology are very basic. The most important ingredient for this system is to find clear price charts that show accurate price action (without bad ticks).

Some Internet services enable the user to exactly define prices by clicking on the price bar of a chart. If you find yourself inaccurately "guess-timating" stock charts, I would suggest finding a good service that might cost you some money. However, it will definitely save you money in the long run with more accurate calculations.

Another basic tool needed to calculate the numbers is a simple spreadsheet. A spreadsheet can be easily formatted with a few formulas that will calculate the range of numbers for the potential reversal zone. I suggest that you program your spreadsheet exactly as I have in the following example.

	A	B	C	D	E	F	G
1	Symbol		.382	.618	.786	1.27	1.618
2	X-A						
3	Input X	Input A	=(A3-B3)				
4		=C3	=B4*.382	=B4*.618	=B4*.786	=B4*1.27	=B4*1.618
5		=B3	=B5+C4	=B5+D4	=B5+E4	=B5+F4	=B5+G4
6	A-B						
7	=B3	Input B	=(A7-B7)				
8		=C7	=B8*.382	=B8*.618	=B8*.786	=B8*1.27	=B8*1.618
9		=B7	=B9+C8	=B9+D8	=B9+E8	=B9+F8	=B9+G8
10	B-C						
11	=B7	Input C	=(A11-B11)				
12		=C11	=B12*.382	=B12*.618	=B12*.786	=B12*1.27	=B12*1.618
13		=B11	=B13+C12	=B13+D12	=B13+E12	=B13+F12	=B13+G12
14	C-D						
15	=B11	Input D	=(A15-B15)				
16		=C15	=B16*.382	=B16*.618	=B16*.786	=B16*1.27	=B16*1.618
17		=B15	=B17+C16	=B17+D16	=B17+E16	=B17+F16	=B17+G16
18							
19					AB=CD	1.27AB=CD	1.618AB=CD
20					=B11-B8	=B11-F8	=B11-G8

Although this spreadsheet may seem complex, it is actually quite simple to determine the "spread" of Fibonacci numbers. Also, you might be wondering why I included the 0.382 retracement in the calculations. I consider the 0.382 calculation as the first area to examine in a price move. Sometimes, I will substitute the 0.382 with the 0.50 retracement.

The beauty of this spreadsheet lies in the gamut of Fibonacci numbers that exist within the price moves. For example, if a pattern has been identified, I can easily compare each price leg to determine which Fibonacci number was the reversal point. In addition, I can quickly determine the area where the greatest number of Fibonacci calculations converges.

After you develop your eye to identify price patterns, the calculations to determine the potential reversal zone are very simple, as the spreadsheet demonstrates. If you can add, subtract, multiply and divide, you can determine the areas that have the highest probability for a reversal. So, if you like crunching numbers, these calculations will be very enjoyable. If not and you have the money to spend, I suggest that you invest in a software program. But, I do believe there is a great deal of benefit to doing the work by hand.

Although it is more time consuming, I suggest that you calculate the numbers manually – without computer software – at first. When you initially utilize this methodology, it is important to develop “a feel for the numbers.” Although these techniques reveal potential reversal areas, a stock’s price action does not always “bounce” off the precise retracement calculation. Also, a potential reversal zone usually includes several numbers within a specific price zone. So, it is important to “gauge” the market action to determine the best price point for the trade execution.

Calculating the numbers manually promotes a greater understanding of the various calculations converging in a specific area. It has been my experience that the manual calculations have helped me develop a better “feel” around the potential zones and execute these opportunities more successfully.

I would like to add one final note about doing the work by hand. I have noticed that the best market technicians, at some point in their career, have relied on manual computations as a foundation for a greater comprehension of price action. Before the advent of computer charting programs, the old-time technicians created charts with a pencil and a big eraser to study price action. It really wasn’t that long ago that these “dinosaurs” had to scrutinize a quote machine, to plot the various price points and to study the hand-written stock chart. But, I believe that such detailed work helped these technicians truly understand the market action by studying and contemplating each price bar – point-by-point. In addition, these old-timers often created their own indicators – testing various calculations to discover new market signals.

An “old-time commodity trader,” or should I say an extremely experienced trader-friend of mine, used to work on the Minneapolis exchange in the 1950s. At that time, commodity prices were maintained on a quote machine. As the price within the pit fluctuated, the traders signaled the changes to the person responsible for reporting the commodity prices. Each change was recorded on a paper print machine. At the end of the day, my friend would examine the day’s action by studying the tape – trade-by-trade. He has told me that it was through such scrutiny that he developed his feel for market action.

To this day, some forty years later, he still plots various averages by hand. He relies on longer-term data, weekly and monthly, to gauge market action. He has developed and continues to perfect his own market indicators. His indicators have proven very accurate and quite fascinating. Although I will not explain them in this work (maybe another time, if he

allows), he has developed various gauges, such as a viscosity indicator and a variable moving average that accurately assess the state of the stock market.

I mention these indicators to illustrate that such dedicated number crunching yields an enhanced understanding of price action. I have observed these indicators for many years to substantiate their validity. Also, following these charts with him, I have gained a much greater insight to the nature of price action. Therefore, I encourage you to crunch the numbers by hand, using a spreadsheet, a pencil and an eraser, until a greater "feel" is attained.

20

Developing the Trading Plan

Trading Rules

Consistently profitable trading requires specific rules to define opportunities and to guide optimal executions. Trading rules prevent irrational behavior, such as an "impulse" trade. Impulse trading is really just guessing - that's it! I confess to my share of impulse trading. However, effective trading rules, as defined by the harmonic techniques, have provided me with a system that has proven itself over time.

Although these methods do not yield a reversal every time, I believe that an excellent set-up - three or more numbers in the potential reversal zone - will yield a profitable reversal seven out of ten times. This is a subjective assessment, however I actually consider it a conservative estimate. After studying the overwhelming number of charts in this book, it should be clearly evident that these methods are incredibly effective in defining opportunities.

Execution

Although this method has been proven to discover critical reversal points in stocks, proper execution of a trade set-up will determine your success or failure as a trader. The key to successful execution is gauging the price action in the potential reversal zone. There are many harmonic set-ups that do not yield a reversal. The previous example of America Online was a good example of a very harmonic set-up that did not reverse ideally.

In the case of AOL, the execution was very tricky. The stock traded a total of 50 points! Initially, it declined over 20 points, and then the stock rallied almost 30 in the next three days. Although the potential reversal zone was blown out, the set-up still yielded a very substantial rally.

This example illustrates the concept: "Anything can happen in the stock market." The stock market will do anything it wants to, whenever it wants to! Preparing for such uncertainty will ensure greater success. Therefore, it is essential to develop guidelines to act consistently and prudently in these situations.

Trading rules will guide your behavior throughout the trade process, especially since these situations can be extremely emotional. At times, the emotional element can cause flawed executions. Specifically, the emotions of fear and greed could cause you to jump in too soon or sell too early.

I have made more mistakes in trade execution than I want to admit. There have been many times when I have bought stocks when I should have been selling. Also, there have been other times when I have held on for greater profits, only to give it all back. I just want to say that you are going to make mistakes. It is a part of the learning process. But, there are ways to improve your trading and prevent future mistakes.

Trading Plan

A personal trading plan is your own system that will ensure success. It is important to create your "plan of attack." The trading plan will help you identify profitable opportunities and make better trading decisions. I have included my own plan that I use to analyze a set-up. Before I execute a trade, I assess a stock based upon this checklist of questions.

1. Is there a pattern?
2. What is it?
3. Is there an $AB=CD$?
4. Where does it complete?
5. Are there 3 or more numbers converging in the potential reversal zone?
6. What are they?
7. What are the time cycles (symmetry) suggesting?
8. Are there any warning signs? (price gaps, wide ranges, tail closes)
9. At what point is the potential reversal zone no longer valid? (Stop Loss)
10. How much must I risk?
11. Am I willing to risk it?

If your set-up abides by this checklist and you are willing to accept the risk, the trade is probably a valid execution.

Trade Requirements

There are a few requirements that I use to screen potential trade set-ups. When looking for potential candidates, it is important to follow highly liquid stocks – stocks that trade an average of a million shares a day. Although I have observed very harmonic price action in stocks that trade only a few hundred thousand shares a day, I strongly suggest that you stick with the big companies. Also, it is important to look at the largely capitalized companies that are frequently in the news. Groups, such as the Dow Industrials, NASDAQ 100 and NYSE top 20, provide good potential candidates for trade opportunities. Also, I frequently review stocks that are on the most active volume.

Requirements:

1. Liquid Stocks (in excess of 1 million shares traded daily)
2. Minimum chart time frame = 30 minutes; daily and weekly charts must be referenced to determine trend direction and other larger possible price implications
3. Daily trade journal: trades must be prepared before market opens or day before; must record trade action and personal behavior
4. Chart record: following each trade, I must print out the chart recording entry and exit points, profit/loss and other comments;
5. Overall trade record – Equity curve: I must always be cognizant of my personal equity curve understanding average loss/win, time frames, and equity drawdown.

These rules provide a consistently effective method of identifying opportunities. It is important to develop your own trading plan. It can be similar to this, or it could contain other rules or techniques, which you create to help determine when to execute a trade.

Once you have developed a plan for trade execution, you need a plan to determine when to take profits or to cut losses. Knowing when to take profits or cut losses can be difficult, especially when you have not planned your execution in advance.

21

Gauging the Profit Potential

Knowing when to take profits in a valid reversal is probably one of the most difficult decisions to make. Although the decision is very subjective, selling rules can improve your executions. Your ability to take profits will determine your success or failure. Therefore, it is important to create rules to help cut losses to a minimum, while letting the profits ride.

Consistency

In my opinion, the most important concept of trading is to be consistently profitable. This is not an easy task. It requires that you identify profitable opportunities correctly, execute the trade effectively and take profits accordingly. Consistent profitability can be achieved through defining your actions in advance. Creating a plan to take profits will help increase profit consistency.

Some of my best trades have been when I have taken very paltry profits. When a stock does not act the way it "should," I get very apprehensive. Of course, I want the trade to work out for me. However, this struggle, of wanting to have the market move in my direction versus the reality of what is happening, can be very difficult to overcome. It takes some time before you can differentiate between these two realities.

Mark Douglas, author of The Disciplined Trader and Trading in the Zone, is an expert in this area. I strongly urge you to read both of these books. He clearly explains the psychology needed to be successful. He stresses the need for trading rules, as the means to be consistently successful in the market.

I was not consistently successful until I developed my own trading rules. Although I have included my own trading plan, I strongly encourage you to design your own rules. But, this means that you have to follow the rules! This can be difficult, since dangerous emotions of greed and fear can influence trading behavior.

Exit Rules

I maintain several rules when I am preparing to exit a trade. I calculate the "spread of Fibonacci numbers" that could act as a future reversal point. The spread of numbers consists of both primary and secondary numbers. They are: 0.382, 0.50, 0.618, 0.786, 1.00, 1.27 and 1.618. For example, if I bought a stock on a daily set-up, I will calculate the spread from the previous high to the recent low. I will then examine the stock as it rallies through these points. If a stock experiences resistance at a Fibonacci number, I will usually take my profits and look for another set-up. However, this is dependent upon the price action out of the potential reversal zone.

Continuation Strategies

After I execute a trade, I use a very simple technique to determine the extent that I stay in my position. It is based on analyzing the price action's continuation after a reversal.

As the following illustration demonstrates, price action that continues in a clear direction will keep me in a trade. Using the buy example, if a stock rallies off a potential reversal zone and continues to make higher highs

and higher lows, I will stay in the trade. Although this may seem rather simplistic, many harmonic set-ups yield very strong reversals with overwhelming continuations.

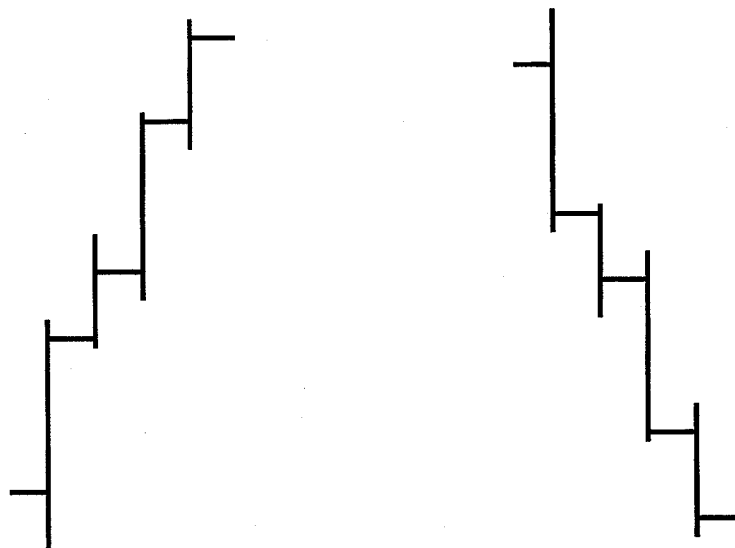

Bullish Continuation

Bearish Continuation

As a stock rallies, I scrutinize the areas where critical Fibonacci numbers exist. If a stock begins to reverse off a Fibonacci number, I will take profits. Sometimes, I will sell half of my position and let the other half ride, in case the stock continues its rally.

Another important consideration in taking profits is to examine the previous price bars. In the buy example, if I am using a daily chart, I want to closely watch the previous day's high, low, open and close. Ideally, I want all four components to be higher than the previous day. However, the ideal situation does not always occur. Therefore, it is important to assess these components, as means of determining areas to take profits.

I believe the high and the low are very important in indicating the future trend of a stock. In the buy example, if a stock can make new highs, I regard this price action as very significant. Also, a stock can stay above the previous day's low would suggest strong price action.

The high and low are important, when they are combined with the open and close. As I have previously discussed, bullish and bearish price

bars indicate the nature of trading during a specific period of time. In the buy example, a stock that makes a new high as compared with the previous day's price action can be strong. I say "can be," because the strength of the move is dependent upon the nature of the price bar. If the price bar is bullish - the close is higher than the open - I will stay in the trade. However, if the stock finishes with a bearish close, despite making a new high, I will become very suspect of the strength of the move. I will wait another price bar (the next day) to examine the following action. But, I will be prepared to sell, since the price action is potentially weak.

Comparing price action components in combination with Fibonacci numbers can indicate good areas to take profits. Although this technique is somewhat subjective, it is important to analyze closely each price bar to gauge the true strength of a stock's move.

Personal Rules

Another factor I consider in determining when to take profits are my reactions to a trade. Although it has taken me some time to develop these signals, there are certain personal rules that I maintain that indicate when to sell. These are very subjective, but I have found these signals to be very reliable under these conditions.

When I am in a profitable trade, I can get caught up with all of the money that I am making. The problem with this "money-made" mentality is that I only receive the profits, if and when I close my position. I had to learn this lesson the hard way, as I have let sizeable profits become substantial losses on more than one occasion. Therefore, when I find myself mentally calculating my profits, I know that I am close to closing the trade. Although this is a very subjective rule, it has taught me the importance of not getting too greedy.

Another consideration is to take profits after a sizeable gain has occurred in a short period of time, regardless of "future prospects." If I have a stock that has made a significant move in a day or one week, I will be inclined to take the profits. I had to learn this rule the hard way! I have been in many situations where I was up a great deal of money, only to give it all back. Getting burned by these experiences has taught me to take profits sooner rather than later. Although I have "left money on the table" in the past, this practice has increased my profit consistency.

Contrarian Thinking: "Don't Believe the Hype!"

Another personal rule is regarding the news media. I maintain this attitude whether I am entering or exiting a trade. If I have a profit in a stock that is in the news, I will assume a contrarian attitude and get ready to close out my position. Such contrarian thinking will help avoid getting caught up in the hype.

When such publicity coincides with a potential trade set-up, it has been my experience that the following price action usually moves counter to the news event. For example, if a bullish news announcement coincides with a bearish set-up, I will wait, let the stock rally a little while and then execute the trade.

Major announcements such as a new product launch, earnings releases or stock splits/buy backs might affect a stock for a short time. However, the following price action eventually moves counter to the news event. These situations are nothing more than hype. After the hype settles, a reversal in the following price action is the usual result.

Developing a contrarian view to news items might take several experiences to be able to think in this fashion. It is fascinating that a contrarian view to widely publicized stocks corresponds so frequently with many harmonic set-ups.

I suggest that you track a few stocks and the corresponding news items. For example, let's assume a stock has a bearish Butterfly forming on the price chart. At the same time, there is an overwhelming amount of good news, such as increased earnings estimates or improved revenue growth, regarding a company that is making its stock rally strongly. You would logically assume that this is a strong stock and probably a good buy – especially because of the good news being publicized. But, according to the price action, the stock is at the 1.27 or even the 1.618 of the XA leg. The trading rules say: "sell." Meanwhile, hesitation or worse, trade avoidance, occurs because you really buy in to the news story. Well, I would like to impart a famous stock market quotation to you:

**"If you buy the headlines today,
you will be selling newspapers tomorrow."**

This conflict between what you see in the numbers and what you believe will cause hesitation or trade avoidance. Unfortunately, it really can

only be overcome through actual experience. After you experience "missing out" on a few harmonic trade set-ups that worked out because you believed the news, you will begin to "trust" the numbers.

I have included this example of Amazon.com because it clearly illustrates this concept. The stock rallied significantly in the weeks leading up to the bullish news announcement. Amazon.com formed a fantastic bearish AB=CD that coincided with this bullish news release.

J.P. Morgan Initiates Coverage of eTailing Sector, Amazon.com

BUSINESS WIRE - December 09, 1999 13:01

SAN FRANCISCO, Dec 9, 1999 (BUSINESS WIRE) -- J.P. Morgan Securities Inc. equity research analyst Tom Wyman today initiated coverage of the eTailing sector with a 40-page industry report. He also launched coverage of the following stocks:

-- Amazon.com (Nasdaq:AMZN) with a "BUY" rating and a 12-month price target of \$160

In his report, "eTailing and the Five Cs: Building and eTailing Megabrand Through Content, Community, Customization, Commerce and Customer Care" Wyman calls eTailing "the new shopping paradigm that will forever change the way goods and services are bought and sold." However, he adds that not all eTailers are created equal: "The competitive pricing of the Internet and low barriers to entry mean that in the emerging eTailing battle, brand equity matters as never before. Those that create discount-oriented commerce-only web sites will likely become roadkill on the eTailing superhighway."

"Competing on price is not a sustainable competitive advantage over the Internet in our view," says Wyman. "We believe the winners will be those eTailers that build their brands by creating a 'destination' online store experience known for great selection, information, customer service and prices that meet -- but do not necessarily beat -- bricks-and-mortar-prices."

Copyright (C) 1999 Business Wire. All rights reserved.

And now for the reality:

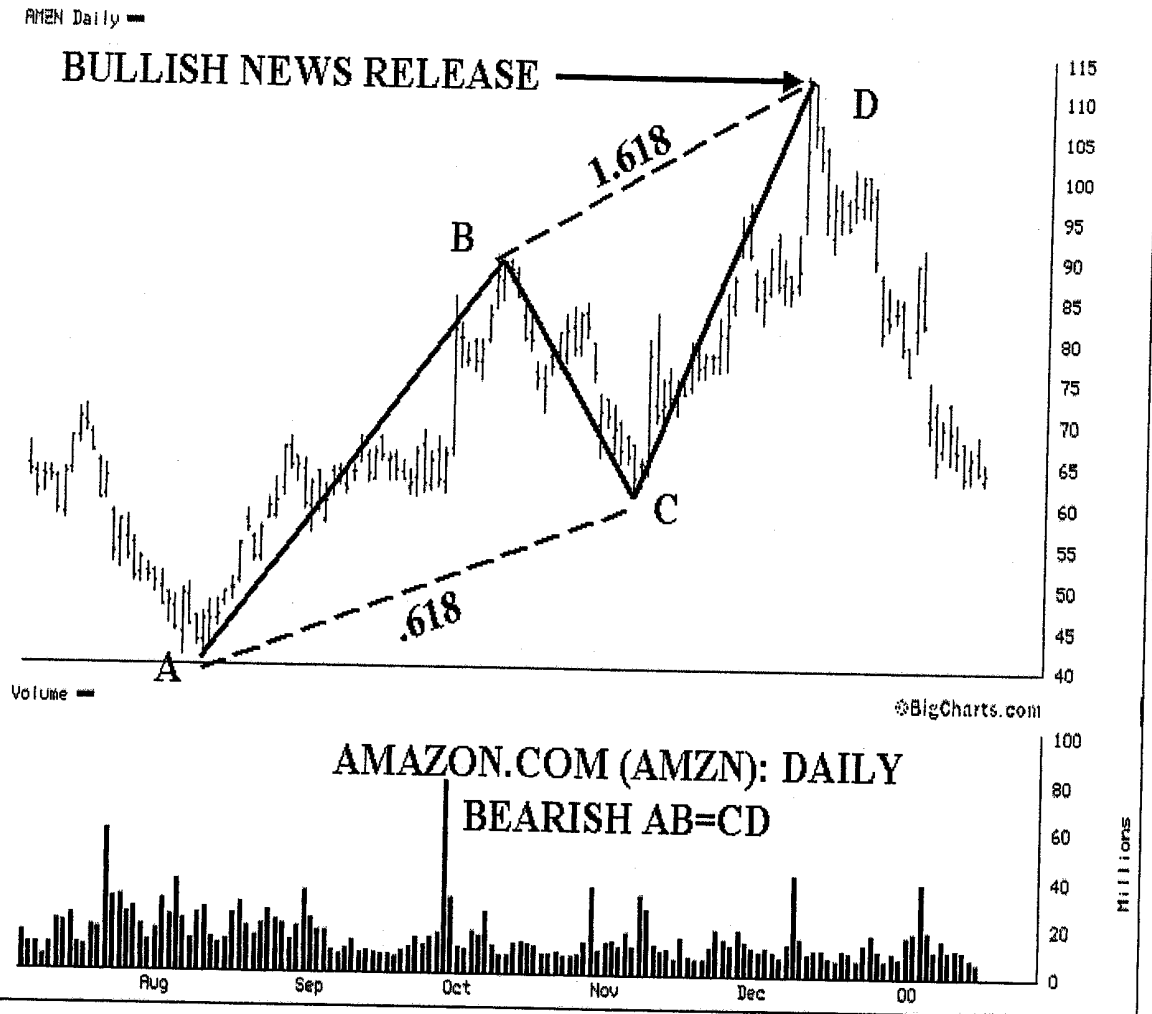

Clearly, Amazon.com formed a distinct bearish pattern that reversed almost exactly off the completion of the AB=CD. Within the following few days, the stock plummeted, falling nearly 20 points.

These situations materialize frequently. It is important to "trust the pattern" and ignore the news story. One way to look at such a situation is to ask yourself: "With all of the bullish news, how much better can it get?" After witnessing a few of these situations unfold, you will begin to realize that such news stories are contrarian indicators, especially when they coincide with very clear patterns.

A contrarian attitude helps separate the news from the facts. If you perceive goods news as an opportunity to sell and bad news as an opportunity to buy, you train your brain to think in a "buy low, sell high"

framework. A contrarian attitude is the same as utilizing the $AB=CD$ framework. It is tough to think this way because your brain has been trained to associate good news as strength and bad news as weakness. Typically, a stock that is rallying nicely would be considered strong. Your brain will instinctively tell you to buy the strongest stocks and avoid the weakest. This is where the numbers come in to help you think outside the lines and interpret the price action from an unemotional perspective. When your brain is telling you one thing and the numbers suggest something different, it is crucial to maintain an unbiased perspective to be able to identify the best trade set-ups. Furthermore, it is essential to trust what the harmonic numbers are indicating. This trust will develop, as practical experience proves the validity of the numbers to be more reliable than good news items.

Sticking to the Plan

Stock Journal: Recording the Experience

It is very important to maintain a written journal to keep track of potential trade set-ups. A stock journal should include the type of pattern, the completion point of the AB=CD and the Fibonacci retracements within the reversal zone. Also, a written journal is helpful in recording your personal thoughts regarding the relative price action within a reversal zone.

It is important, especially in the early stages of learning these techniques, to keep track of your thoughts. The thoughts and ideas that are generated during the trade execution process are your personal signals that help gauge the price action. It is important to record your feelings and expectations relative to the current price action.

The key to trade execution of harmonic set-ups still requires to properly gauge the price action within the reversal zone. Achieving the "feel for the numbers" requires an understanding of your own personal signals. Your stock journal will record your mental processes and trading behavior. It is only through such study that you will improve your executions and become a more successful trader.

I recommend that you "mock-trade" or "paper trade" for a few months to observe how these set-ups work out in actual examples. Throughout this book, I have provided many educational charts that show how the price action responds to the patterns and numbers. But, real experience is the best means to develop the feel for these techniques.

A stock journal acts as the actual record of your trading behavior. There are many set-ups that are missed. It is easy to see these set-ups that

have worked out after the fact and lay claim to what would have been. Also, it is easy to pick the “well-chosen examples” and demonstrate the validity of these methods from the past.

Although these are effective means of study, in the real-life situation there are many other variables that will influence your trading judgement. It is very similar to a basketball player who practices free throws. The player might be able to make ten in a row in practice. But, if that player is put in an arena with thousands of opposing fans, the environmental conditions will influence his shooting ability. Furthermore, the player will not be consistently successful until he/she experiences actual game experience. The stock journal is the real-life scorecard.

I have included a sample of my own journal that shows how I approach trade set-ups. I line the various set-ups in “my sights” and wait for them to materialize. If they don’t work out the way that I have projected, I move on to the next trade. If I do see a set-up that comes together, I gauge the price action. After the opportunity is over, I summarize the events and my response to the opportunity. If I accept a trade, I will record my thoughts and feelings throughout the entire experience until I am out. Here is a sample from my own journal.

8/13

UAL = AB=CD @ 71; 127 @ 69.....CLOSED YESTERDAY SHORT OF 127 and warning sign = gap down on the open today below 69.....wait for 1618 @ 63.25 for potential buy

AOL = mini-3 DRIVES OFF TOP COMPLETE RIGHT @ THE 618 – ALMOST EXACTLY!!!!!!...MUST HOLD LOW FROM 8/5 OR THIS IS GOING TO GET WHACKED AGAIN

FDX = SELLING OFF INTO MAJOR 1618; THIS IS CLOSE TO A BUY!!!!!!!!!! WAIT FOR AB=CD to complete around 50; a good set up though! Price action stabilizing! It's almost past the 1618, so I'm very close!

JPM = Critical Support Levels: @ 618/786 = 111.1875/104.6625

As you can see by my journal entries, I have identified several trade set-ups for potential opportunities. It is not uncommon for me to follow a stock for a week or two, especially when I am tracking price action after a

nice harmonic set-up. I urge you to use a written journal religiously. I have learned a great deal about price action and harmonic set-ups. In addition, I have learned even more about myself, and my perception of these opportunities.

It is even more essential in the beginning stages of your study because each person's trade executions are unique. Although two people may utilize these harmonic methods and calculate the same potential reversal zone, their execution prices will most likely be different. One person might take the trade, while the other avoids it. The difference lies within the perception of the market action within the reversal zone.

Over time, the stock journal will help you gauge your own personal signals to interpret the market action. In addition, you will develop a feel for what "should be happening." For example, let's say that you have identified a valid harmonic set-up with several numbers within a very tight zone. Specifically, you have identified a great bullish Butterfly pattern. You are looking to buy but the price action suggests an extreme move because of an extreme price range, tail close or gap. You might record in the journal that the pattern looks great but the price action at the reversal point is too strong or has a warning signal, so you avoid the trade. Also, you might record that an ideal reversal "should" bounce off this zone quickly and show strong signs, such as a positive close above the harmonic area. In this example, since the stock is not reversing the way it "should," you have not accepted the trade.

During this time, it is important to record the reasons why or why not you accepted the trade, and the emotions that were associated with your actions. Also, after the opportunity has abated, it is important to record how the trade turned out and how you responded to the experience. Recording these events helps develop your feel of how a stock should act. When you understand how a stock should act, your intuition for gauging price action increases. Furthermore, by developing your intuition, your executions will improve.

Although not all harmonic set-ups are ideal, developing certain standards of price action helps create a framework to gauge the reversal zone. A stock journal that records these experiences is the key to developing your intuition. Each person's response to price action is unique. So, it is imperative to learn the signals that you generate during the execution process to improve future trades.

Chart Record: Labeling the Trade

Another method of improving your trading is to print out a chart of a stock that you traded and label where you bought and sold. By reviewing each trade, you will begin to understand your flaws and strengths. Also, by comparing the chart with your emotions and feelings that are recorded in the stock journal, you will learn a great deal about your trading and yourself.

I have included a chart of a stock that I traded. The stock was Etoys.com (ETYS). I marked where I bought and where I sold.

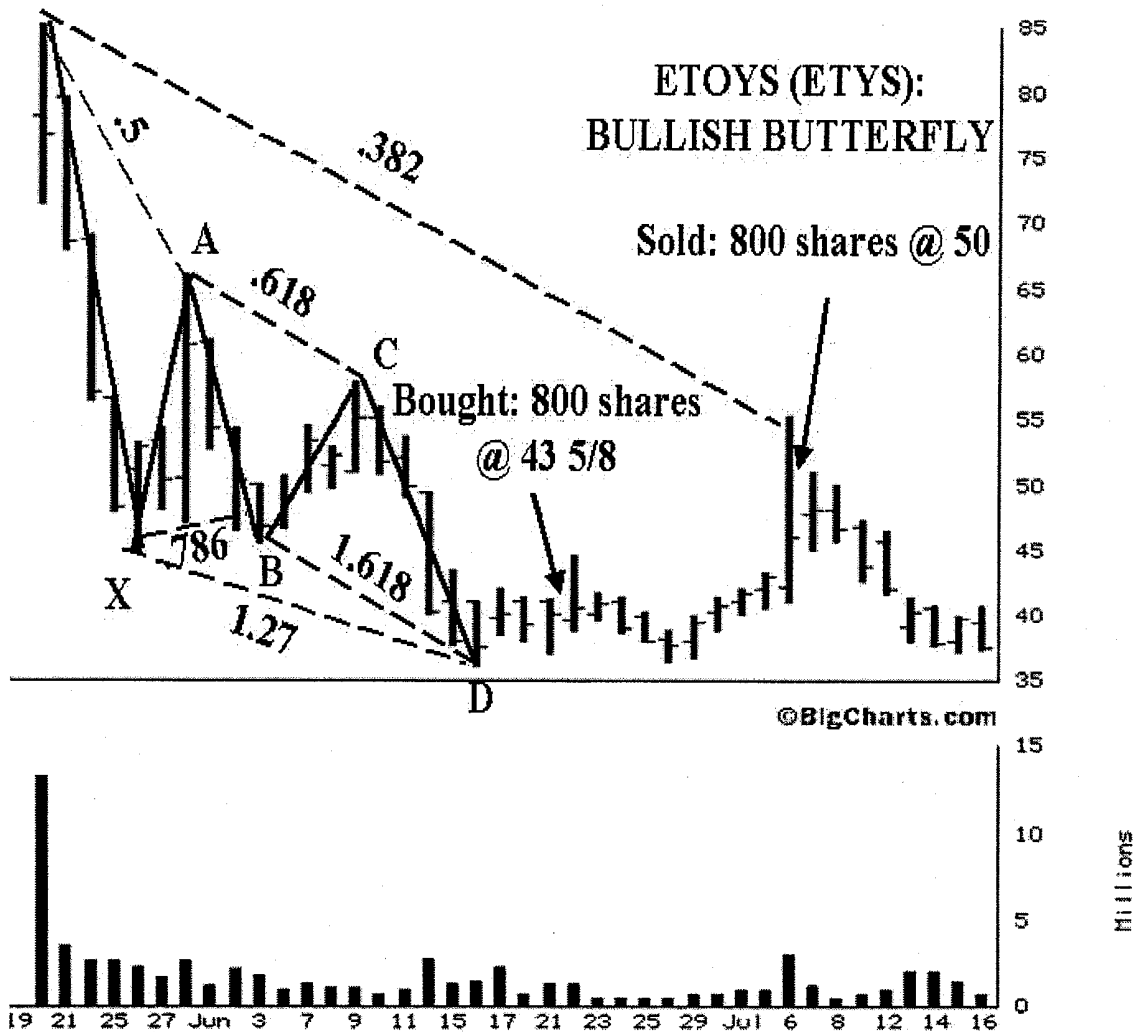

I made some mistakes on this trade, especially since I jumped in a little late on this set-up. But, I was waiting for a clear break out to validate

the reversal. The stock went against me for a few days before rallying. Also, I could have sold my position closer to the .382 retracement. But, the stock was up strongly on this day. After I observed the stock breaking down, I closed my position and took the profit.

Analyzing your trading in this manner will improve your executions immensely. I have learned a great deal from reviewing my past trades and still maintain a file of former trades that I look at from time to time.

Equity Slope: Tracking the Experience

After I record each trade on a chart, I will maintain a total record of all trades on an "equity summary sheet." This sheet tracks my performance of each trade, the total profit/loss, the total equity drawdown and the length of time in each trade. Tracking these results has helped me understand the nature of my profits and losses. For example, I have realized that my best trades are positions that I am in for a week or two - at most. Also, when I do not limit my losses when a trade goes against me, I usually end up with a larger than average deficit. Also, this record will define my "equity slope."

EQUITY SLOPE



CONSISTENT

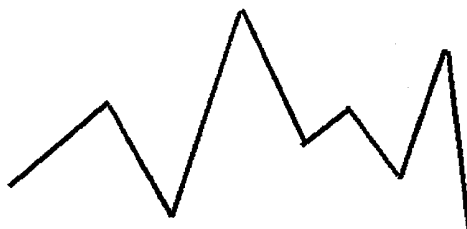

ERRATIC

Equity slope is the degree or angle in which your total equity is growing or declining. The equity slope can indicate the true nature of your trading success. For example, if you have a nice, steadily rising equity slope, this would suggest that your trading is consistently profitable. Although you might experience a few losers, a steady, upward slope is the mark of a consistently successful trader. However, if your equity slope is quite jagged and volatile, rising on big wins and falling on larger losses, your trading is erratic. Such erratic trading is very dangerous, since your past performance indicates that you are susceptible to huge swings and potentially devastating losses.

I can't emphasize enough the importance of recording your performance to be consistently successful. It is the only way in which you will accelerate your learning and prevent you from repeating the same mistakes. Tracking your feelings, thoughts and actual performance are the basis for improvement. After you understand your actual performance, you can reassess your past mistakes and design strategies to improve your trading. If you really want to become a successful trader, these are the true means of improvement.

Conclusion

My purpose for writing this book was to clearly illustrate the effectiveness of these techniques. Hopefully, I have presented the material in a straightforward manner. This material may have seemed very complex at first. But, as the chart examples have shown, a stock's price action is affected by Fibonacci numbers. Also, price patterns have been proven historically that they indicate critical areas for potential reversals. Therefore, if you can do some basic calculations and determine the greatest area where these numbers converge, you will be a successful trader.

This area of convergence - the potential reversal zone - is the most important concept of this book. Although the numbers and the patterns can be different, they are simply elements used to discover the same outcome - where trading behavior will most likely change. As you now know, when several harmonic calculations converge in a defined area, the probability for a reversal is very likely.

The next important concept is to let the market tell you when to trade. Although anything can happen and "the market is always right," the harmonic set-ups will indicate the areas where you should be buying and selling. These methods have a very high degree of accuracy in identifying profitable opportunities. I believe that the stock charts in this book provide enough evidence to support this claim. The most difficult part of the process can be waiting for a clear set-up. But, if you can be patient, the market will

provide ample opportunity to execute successful trades. In fact, there will be some set-ups that are so clear that the entry point for the trade will be obvious.

My last point that I want to leave you with is that you control your own destiny. If you want to be a great trader, you have to be your own strongest critic. Furthermore, you must be willing to invest the time to review your work, sharpen your skills and improve your abilities.

The first step is to record the experience in a stock journal. I can't emphasize the importance of this practice, especially in the initial stages of learning. You will not improve your trading skills unless you record your thoughts and feelings during the experience. The next step is to print out a stock chart of a potential set-up and label each trade, exactly where you bought and sold. Finally, it is essential to maintain a record of your total performance.

After recording this information, you must review this material. Your stock journal and trading records are the most honest assessment of your trading behavior. From this information, you can discover your strengths and weaknesses. If you are doing well, you might want to record the things that you are doing on a consistent basis that are yielding good results. If your trading is not successful, especially after sustaining several consecutive losers, you might want to stop trading and reassess your actions. After recognizing your mistakes, you can design strategies to correct these flaws.

The most important reason to review your work is that it makes you "face yourself." By frequently reviewing your trades, you can develop an honest assessment of your progress. It can be difficult to review your actual trading record. However, it makes you accept full responsibility for actions.

Finally, it is important to keep an open mind, hungry to learn more. There are always new relationships that can be learned. Perhaps, you will discover a new area of harmonic price action that goes beyond this material? I am personally "experimenting" with new techniques and applications of the harmonic methods to analyze price action more thoroughly. Most important, I strive to continually learn as much as I can to perfect my trading.

In my opinion, the only way to be successful in the stock market is through harmonic analysis. These methods are the most effective means for identifying profitable opportunities. As you begin to master these methods in the years to come, you will be amazed how simple trading really is. And, I guarantee that you will never - ever - look at stocks the same way again!

Appendix

Multi-Harmonic Charts

The following examples of multi-harmonic charts illustrate the frequency of these patterns and Fibonacci numbers. It is not unusual to have charts that possess several patterns within one chart. Although these are usually longer-term charts (over a year), the price action in these examples truly substantiates the value of these techniques.

Although these examples might seem complex with many Fibonacci numbers and patterns on one chart, it is important to examine the significant trend changes that occurred after these set-ups were complete. In fact, if you study these examples closely, you will see how the price action seems to form one pattern after another. Another consideration to keep in mind is how these patterns reveal substantial changes in the price action. As each pattern completes, the stock changes its course. In this manner, the patterns clearly indicate a stock's future price action.

These examples are very complex. However, these charts can help you increase your perception to observe similar harmonic price action in other stocks. Although such price action does not occur in every stock, identifying this price action in certain stocks will provide assurance that future harmonic set-ups will be valid. For example, if a stock possesses several patterns within one chart, it is possible to assume that future patterns will yield valid reversals. Although such reasoning is not 100% guaranteed, the probability for future harmonic action is definitely greater in these situations.

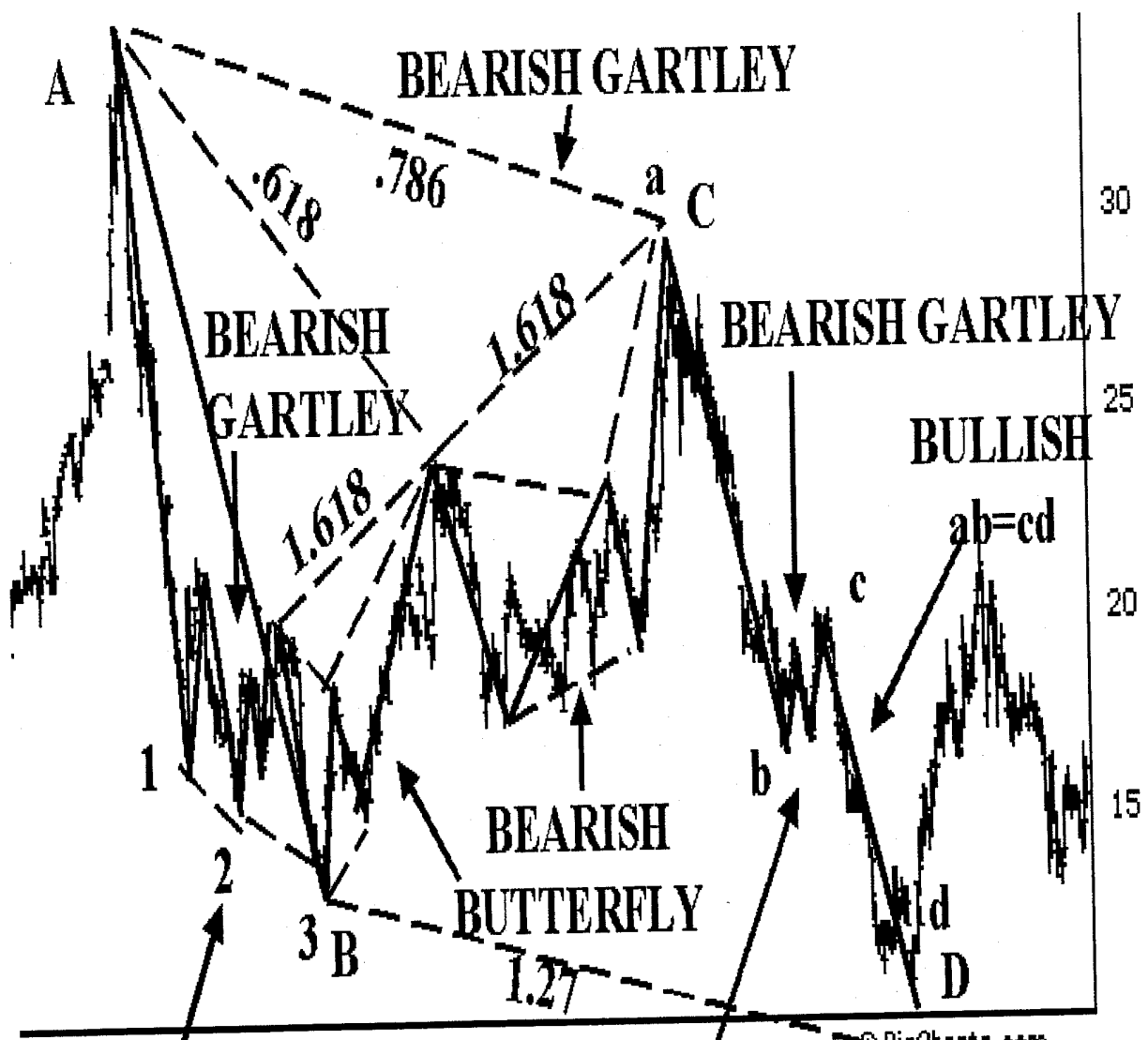

**BULLISH
THREE
DRIVES**

BULLISH AB=CD

**ALLIANCE BANCORP (ANE): DAILY
MULTI-HARMONIC CHART**

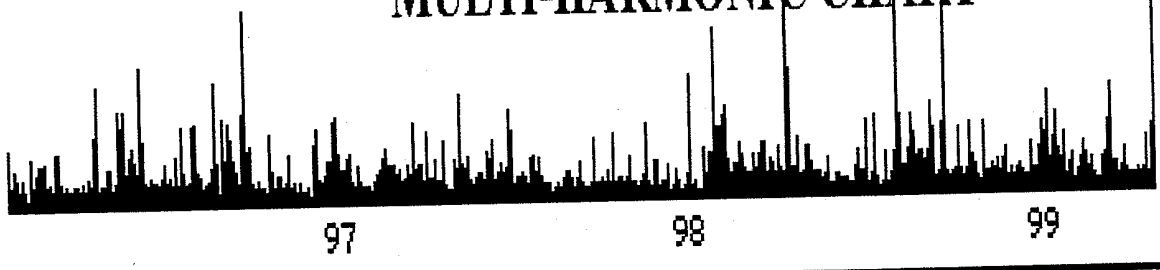

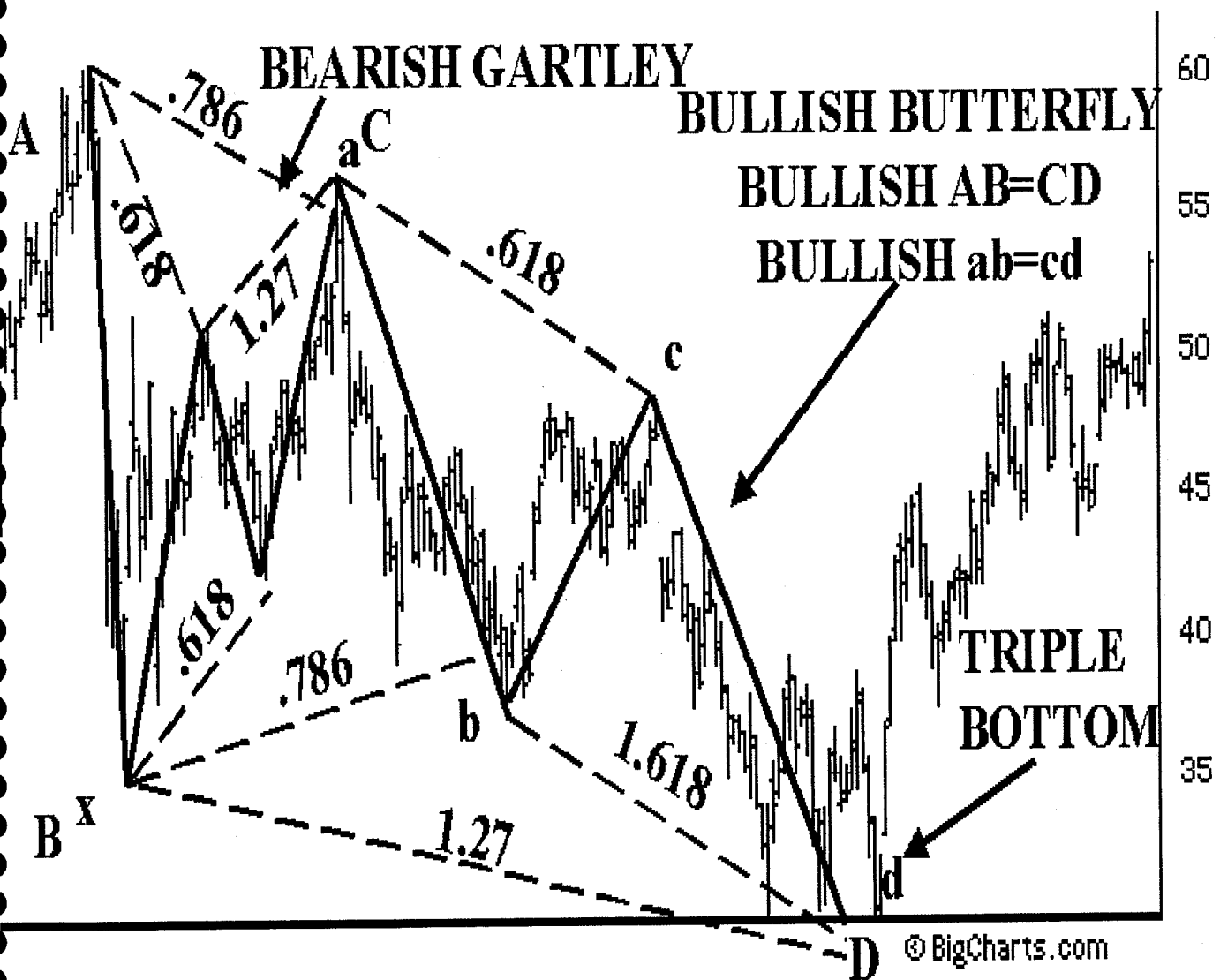

BMCS SOFTWARE (BMCS): DAILY
MULTI-HARMONIC CHART

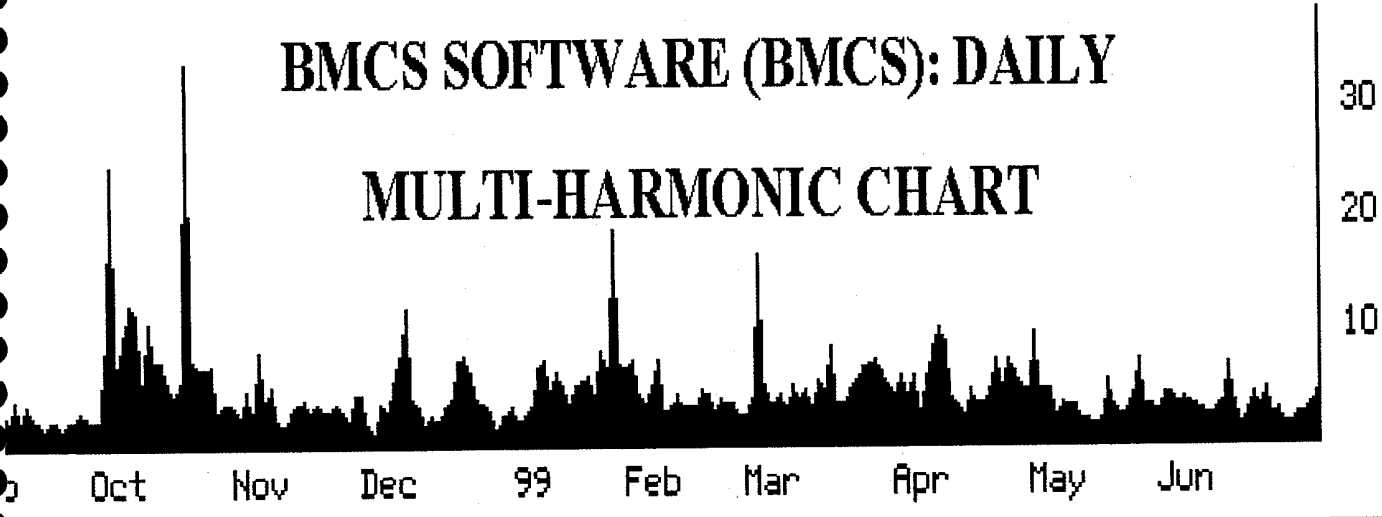

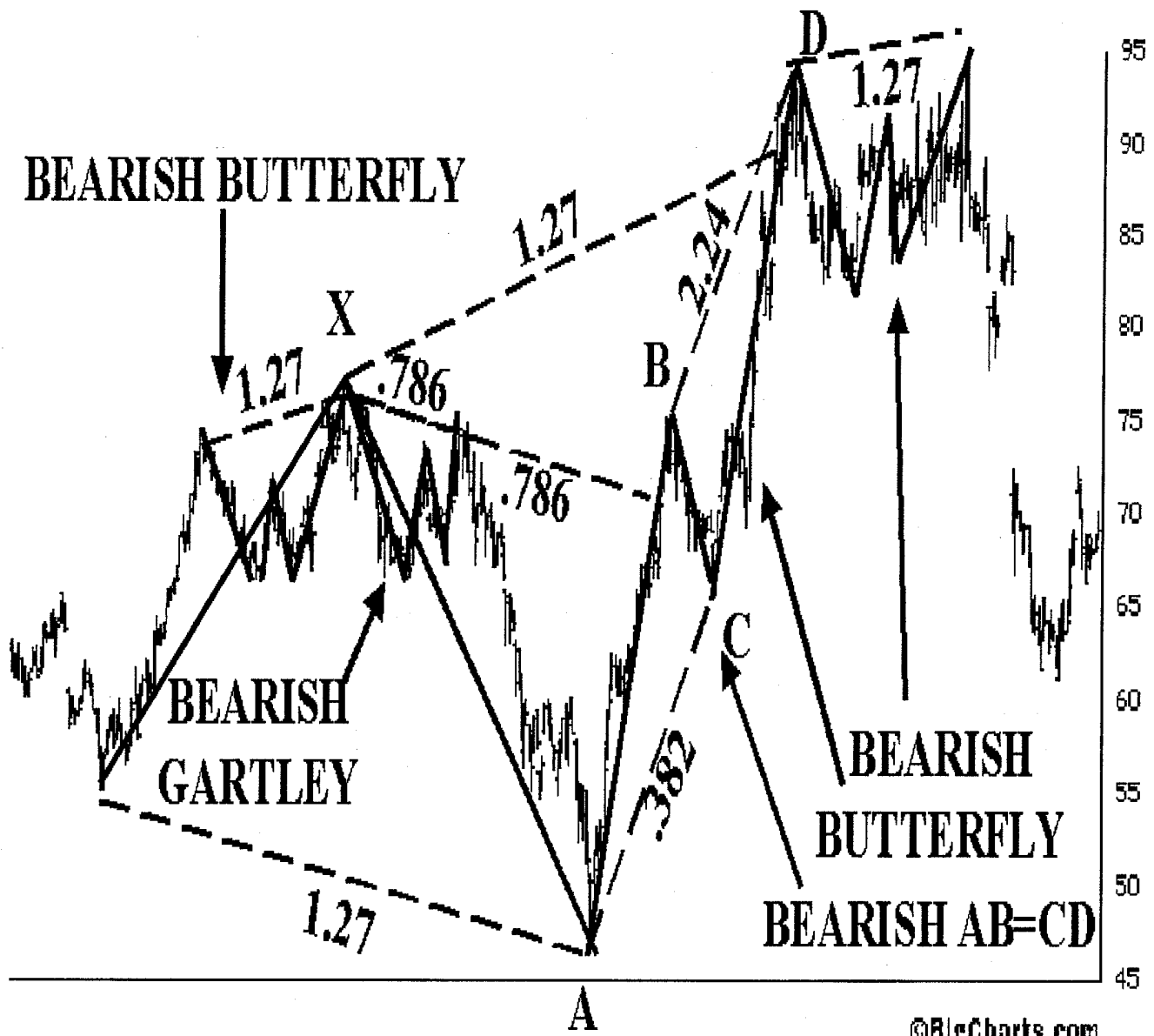

**GENERAL MOTORS (GM): DAILY
MULTI-HARMONIC CHART**

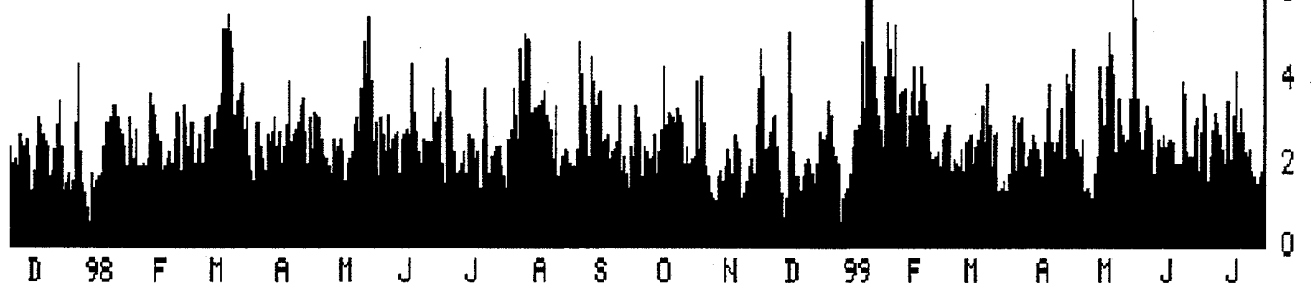

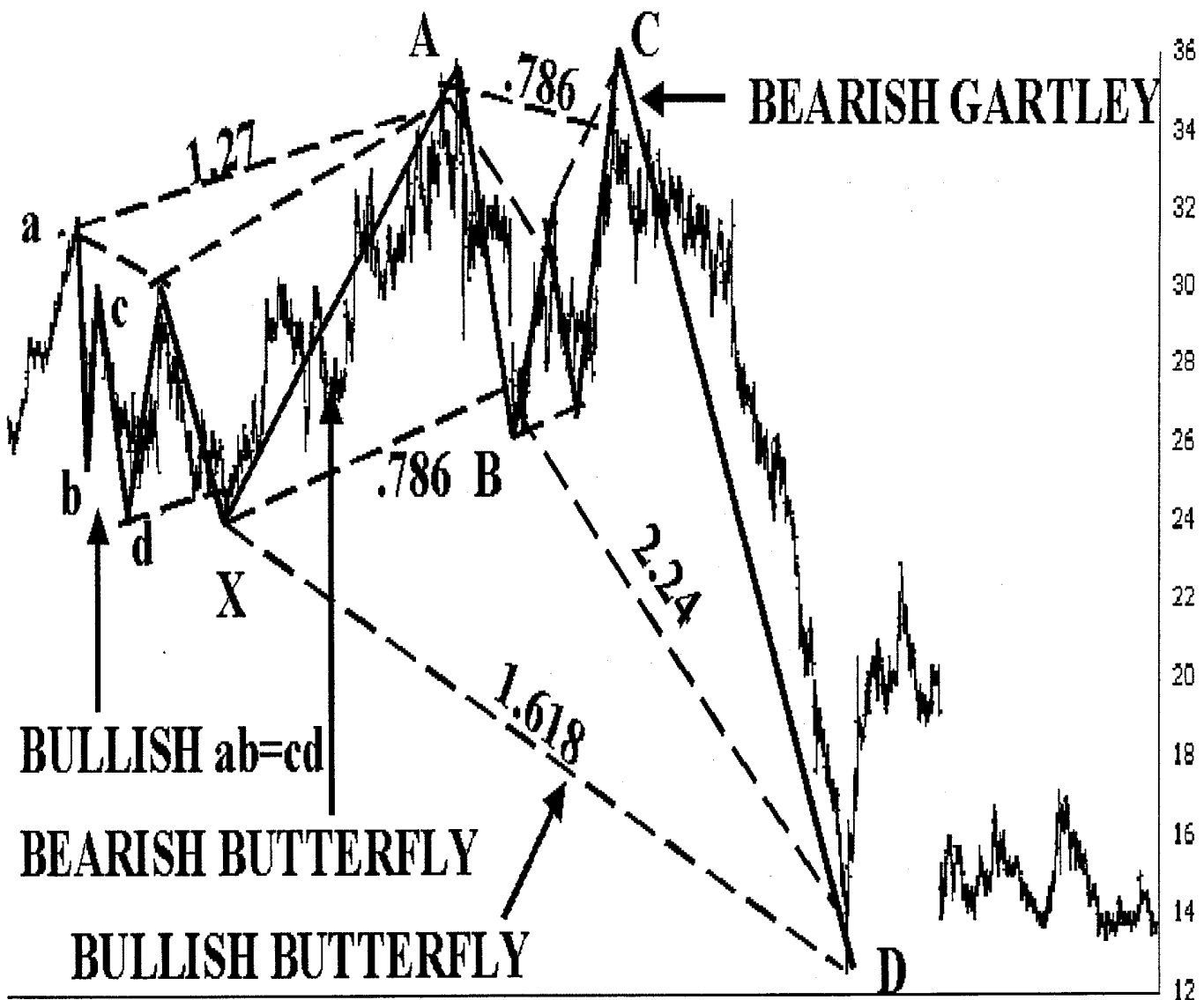

©BigCharts.com

HILTON HOTELS (HLT): DAILY

MULTI-HARMONIC CHART

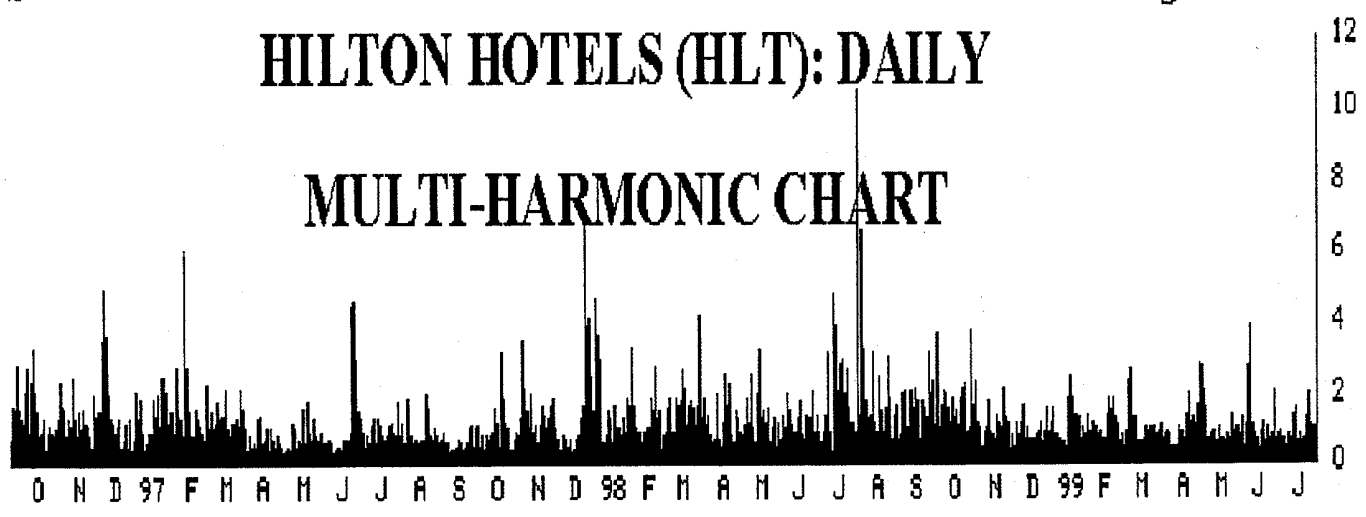

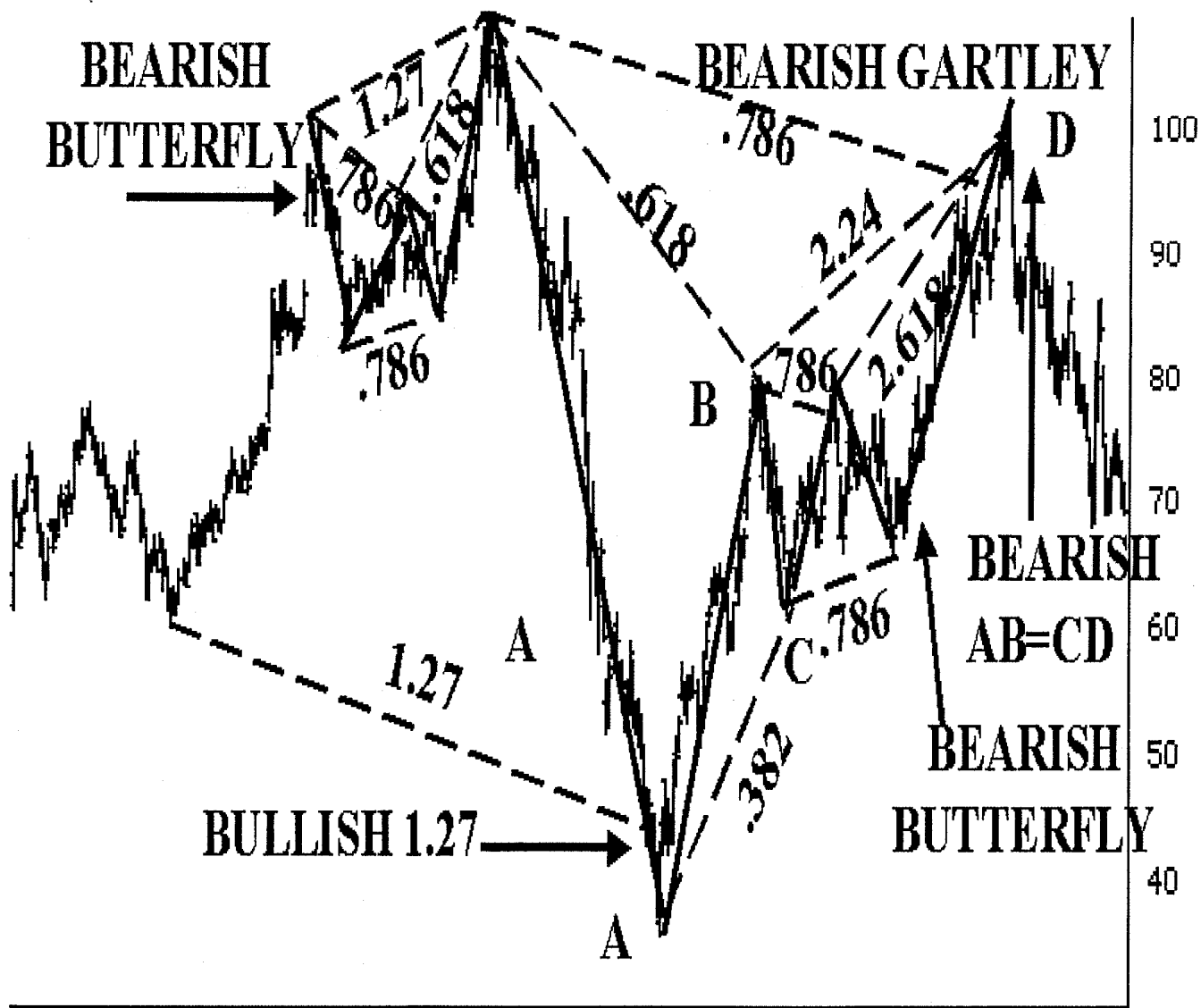

MERRIL LYNCH (MER): DAILY

© BigCharts.com

MULTI-HARMONIC CHART

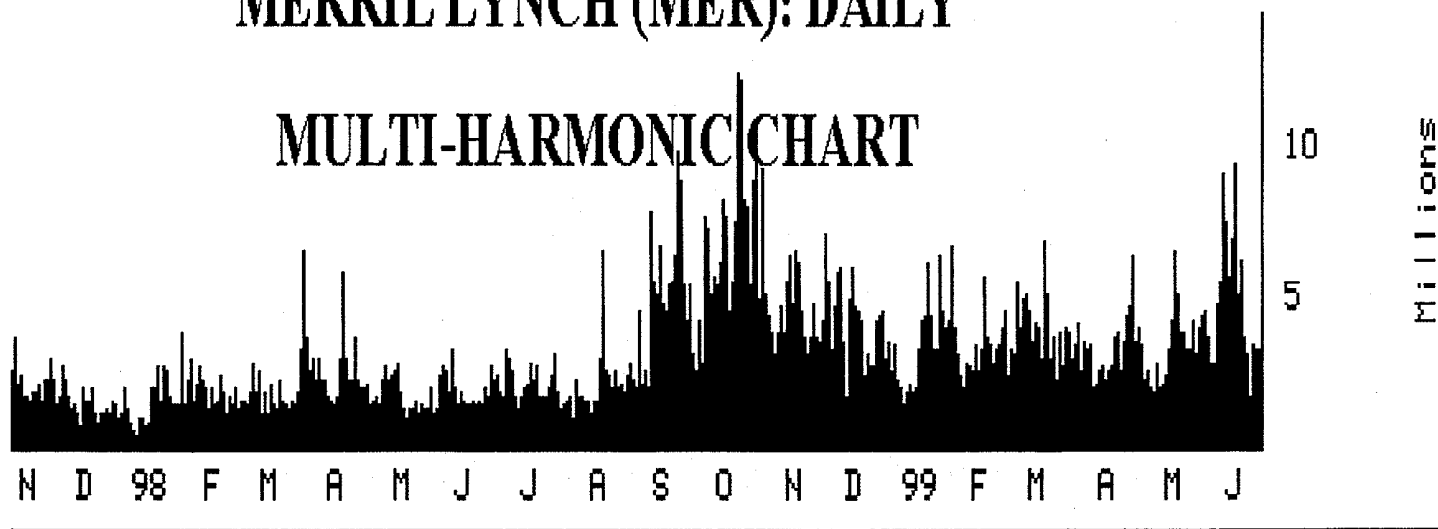

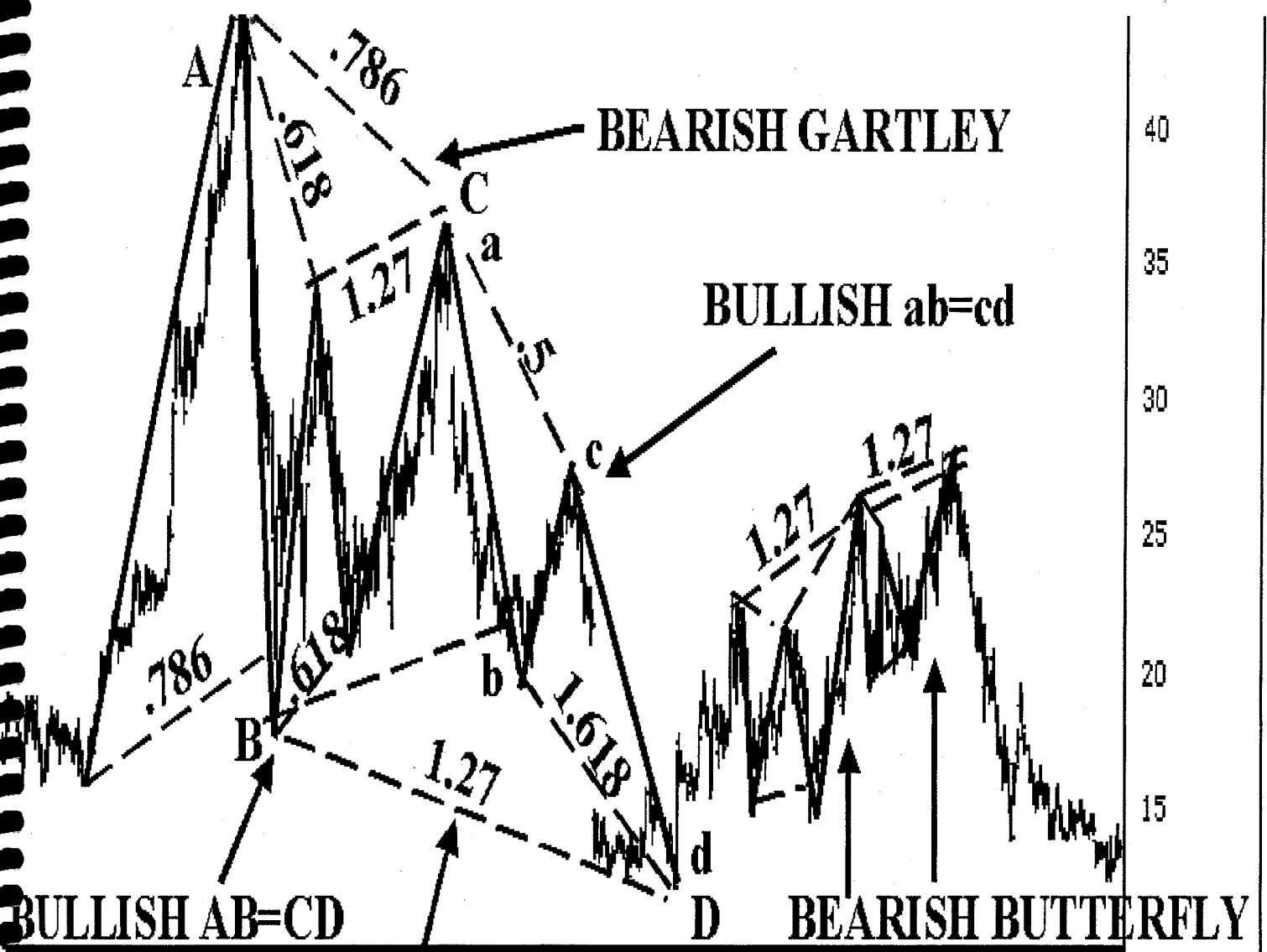

SMART MODULAR (SMOD): DAILY

MULTI-HARMONIC CHART

J J A S O N D 98 F M A M J J A S O N D 99 F M A

Millions
10
5

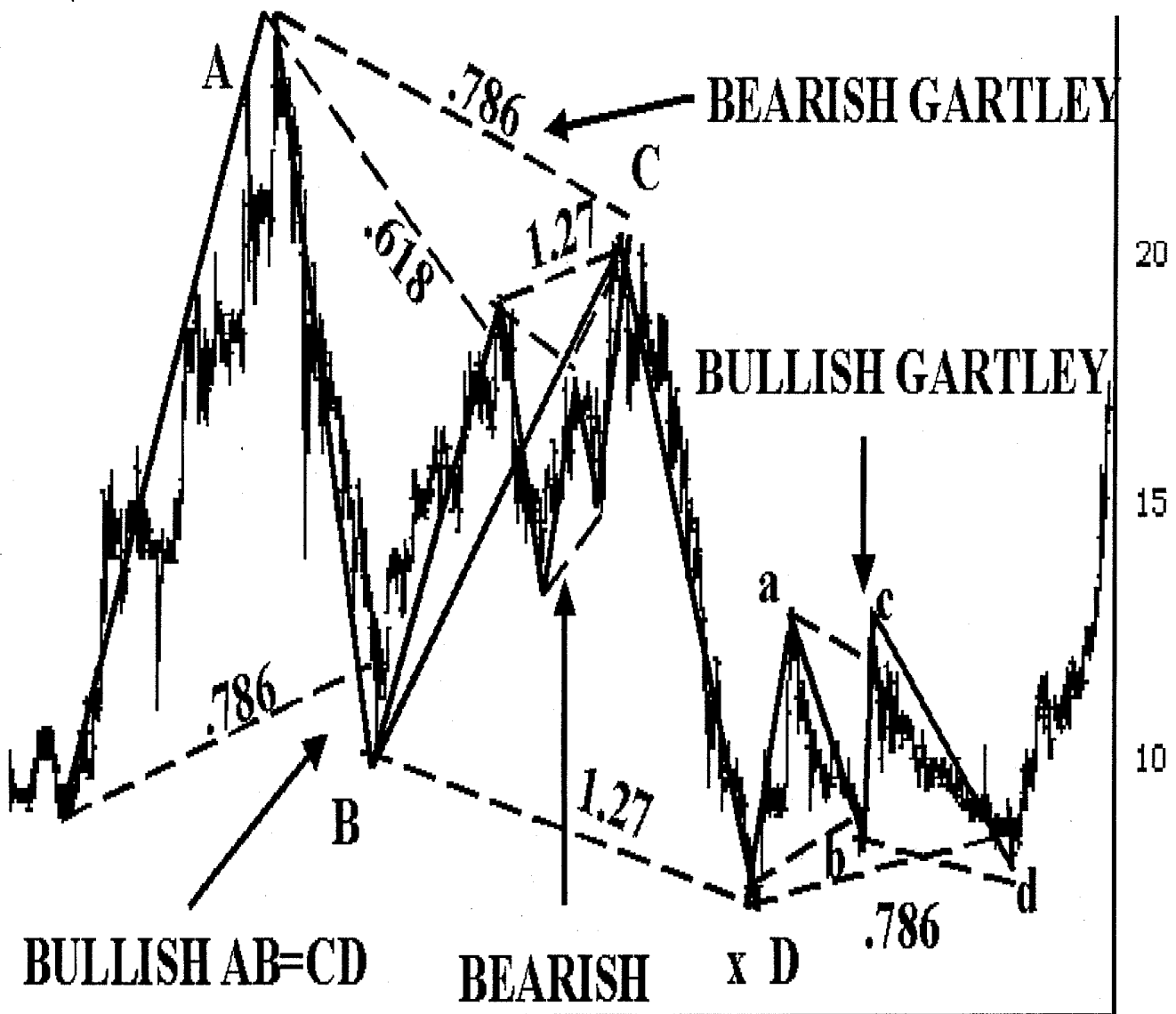

BULLISH AB=CD

BEARISH

x D

$.786$

BUTTERFLY

© BigCharts.com

**VIASAT (VSAT): DAILY
MULTI-HARMONIC CHART**



Millions

Harmonic Stocks

I maintain a list of stocks that are historically harmonic. When I notice a particular stock that "bounces" off Fibonacci numbers and patterns, I watch it closely and wait for nice set-up to materialize. These stocks provide very profitable opportunities because they usually reverse quite nicely off of a potential reversal zones.

The charts in this book contain many examples of multi-harmonic price action. Some stocks, such as Barrick Gold (ABX), Chiron (CHIR), Intel (INTC), Wells Fargo (WFC) and many of the Internet companies, offer very clear harmonic set-ups that yield excellent reversals. Therefore, it is important to recognize these types of set-ups, as especially significant opportunities.

The following list of stocks includes some of the top names in global industry. These companies are traded actively every day (more than million shares). There are many names that you will recognize. But, it is important to emphasize that there will not be harmonic set-ups in every stock all of the time.

There are certain companies that "respond" better to the harmonic numbers. Certain companies seem to bounce from one Fibonacci number to another. Meanwhile, another stock consistently forms patterns. Although these situations are the exception to the norm, if you can find harmonic stocks, your probability for successful trades will increase enormously.

The following list of stocks is not definitive. I am sure there are many harmonic stocks that I have left out. However, I do feel that this is a very comprehensive list of stocks that can offer very substantial opportunities with a low risk. I recommend developing a list of stocks that you review on a weekly basis. You can use the stocks that I have included or add some of your own.

On a final note, I am currently researching harmonic price action in other stock-related vehicles, such as preferred stock and mutual funds. My results have been rather significant, as the price action in these trades seem to possess even greater harmonic price action than stocks. I encourage you to apply these techniques to other markets and investment vehicles. I am certain that there are even better applications of these techniques that have yet to be discovered.

Airlines

1. AMR: American Airlines
2. DAL: Delta Airlines
3. LUV: Southwest Airlines
4. UAL: United Airlines
5. U: US Airways

Banking

1. ANE: Alliance Bancorp
2. BAC: Bank of America
3. BK: Bank of New York
4. BKB: Bank of Boston
5. CMB: Chase Manhattan Bank
6. C: Citigroup
7. FTU: First Union
8. JPM: J.P. Morgan
9. MEL: Mellon Bank
10. PNC: PNC Bank
11. USB: U.S. Bankcorp
12. WFC: Wells Fargo

Computer Hardware

1. AAPL: Apple Computer
2. CPQ: Compaq Computer
3. DELL: Dell Computer
4. GTW: Gateway Computer
5. SCI: SCI Systems
6. SEG: Segate Technology
7. STK: Storage Technology

Bullish Patterns

Bearish Patterns

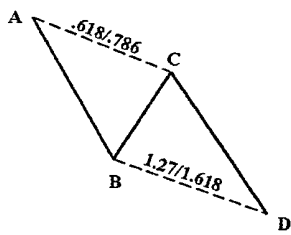

BULLISH AB = CD

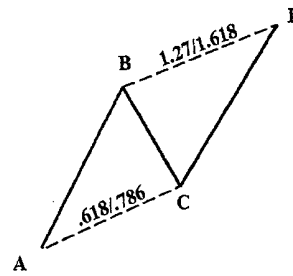

BEARISH AB = CD

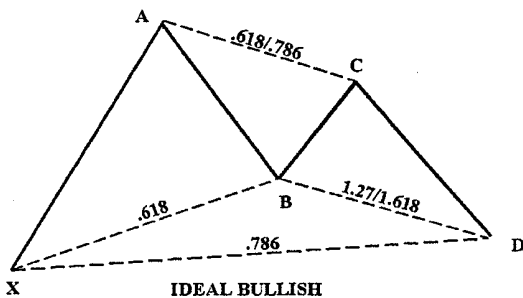

IDEAL BULLISH GARTLEY

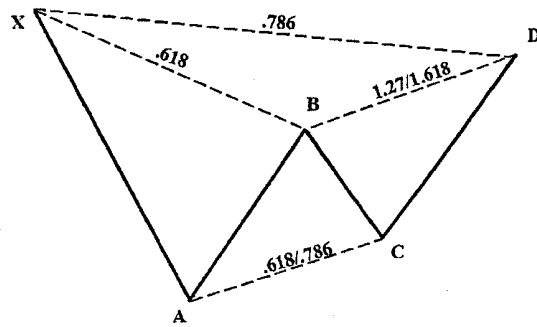

IDEAL BEARISH GARTLEY:

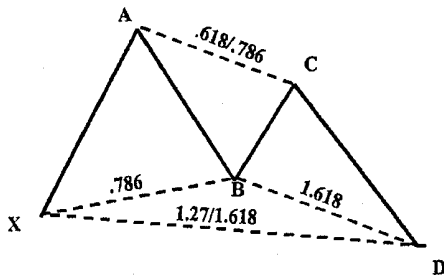

BULLISH BUTTERFLY

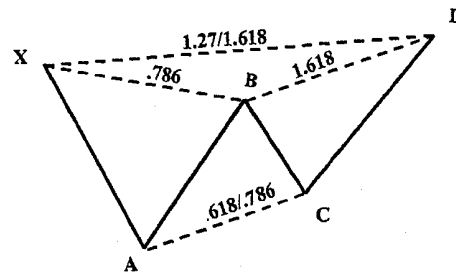

BEARISH BUTTERFLY

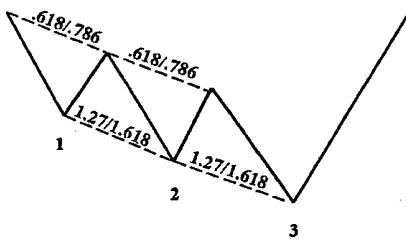

BULLISH THREE DRIVES:

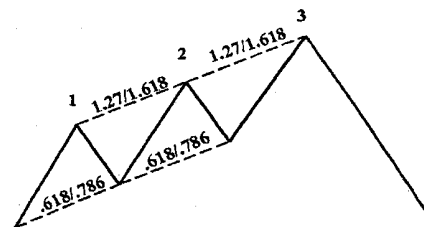

BEARISH THREE DRIVES:

Bibliography

- Cootner, Paul H., *The Random Character of Stock Market Prices*, Massachusetts: M.I.T. Press, 1964.
- Douglas, Mark, *The Disciplined Trader: Developing Winning Attitudes*, New York: New York Institute of Finance, 1990.
- Douglas, Mark, *Trading in the Zone*, Chicago, Illinois: Trading Behavior Dynamics, 1998.
- Figgie, Harry E., *Bankruptcy 1995*, Boston, Massachusetts: Little, Brown and Company, 1992.
- Gann, W.D., *45 Years in Wall Street*, Pomeroy, Washington: Lambert-Gann Publishing, 1949.
- Gann, W.D., *How to Make Profits in Commodities*, Pomeroy, Washington: Lambert-Gann, 1941.
- Gann, W.D., *Truth of the Stock Tape*, Pomeroy, Washington: Lambert-Gann Publishing, 1923.
- Gann, W.D., *The Tunnel Thru the Air*, Pomeroy, Washington: Lambert-Gann Publishing, 1927.

Garret, William, *Investing for Profit with Torque Analysis of Stock Market Cycles*, Ruff Pub., 1935.

Gartley, H.M., *Profits in the Stock Market*, WA: Lambert-Gann, 1935.

Gilmore, Bryce T., *Geometry of Markets*, Melbourne, Australia: Bryce Gilmore & Associates, Pty. Ltd., 1989.

Gilmore, Bryce T., *Geometry of Markets II*, Melbourne, Australia: Bryce Gilmore & Associates, Pty. Ltd., 1993.

Hurst, J.M., *The Profit Magic of Stock Transaction Timing*, New York, New York: Prentice Hall, 1970.

Hurst, J.M., *J.M. Hurst Cycles Course*, Greenville, South Carolina: Traders Press, 1973.

Lanyi, Andrew A., *Confessions of a Stockbroker*, Englewood, New Jersey: Prentice Hall, 1992.

Lefevre, Edwin, *Reminiscences of a Stock Operator*, Greenville, South Carolina; Traders Press, 1985.

McMillian, Lawrence G., *McMillian on Options*, New York, New York: John Wiley & Sons, 1996.

Minor, Robert, *Dynamic Trading*, Tucson, Arizona: Dynamic Traders Group, 1995.

Murphy, John J., *Technical Analysis of the Futures Markets*, New York, New York: New York Institute of Finance, 1986.

Nison, Steve, *Japanese Candlestick Charting Techniques*, New York, New York: New York Institute of Finance, 1991.

O'Higgins, Michael, *Beating the Dow*, New York, New York: HarperCollins, 1992.

- O'Neal, William J., *How to Make Money in Stocks*, New York, New York: McGraw-Hill, 1988.
- Pesavento, Larry, *Fibonacci Ratios with Pattern Recognition*, Greenville, S.C.: Traders Press, 1997
- Prechter, Robert, *Elliot Wave Principle*, Gainesville, Georgia: New Classics Library, 1978.
- Rubinfeld, Alan, *The Super Traders*, Chicago, Illinois: Probus Publishing, 1992.
- Schwager, Jack D., *Market Wizards: Interviews with Top Traders*, Simon & Schuster, 1989.
- Schwartz, Martin, *Pit Bull*, New York: New York Institute of Finance, 1997.
- Soros, George, *The Alchemy of Finance*, New York, New York: John Wiley & Sons, 1987.
- Train, John, *The Money Masters*, New York, New York: Harper & Row, 1980.
- Warren, Ted, *How to Make the Stock Market Make Money for You*, 1966.
- Williams, David, *Astro-Economics*, Saint Paul, Minnesota: Llewellyn Publications, 1959.